



Informatica® PowerCenter
10.5

Transformation Guide

© Copyright Informatica LLC 1999, 2022

This software and documentation are provided only under a separate license agreement containing restrictions on use and disclosure. No part of this document may be reproduced or transmitted in any form, by any means (electronic, photocopying, recording or otherwise) without prior consent of Informatica LLC.

Informatica, the Informatica logo, and PowerCenter are trademarks or registered trademarks of Informatica LLC in the United States and many jurisdictions throughout the world. A current list of Informatica trademarks is available on the web at <https://www.informatica.com/trademarks.html>. Other company and product names may be trade names or trademarks of their respective owners.

Portions of this software and/or documentation are subject to copyright held by third parties, including without limitation: Copyright DataDirect Technologies. All rights reserved. Copyright © Sun Microsystems. All rights reserved. Copyright © RSA Security Inc. All Rights Reserved. Copyright © Ordinal Technology Corp. All rights reserved. Copyright © Aandacht c.v. All rights reserved. Copyright Genivia, Inc. All rights reserved. Copyright Isomorphic Software. All rights reserved. Copyright © Meta Integration Technology, Inc. All rights reserved. Copyright © Intalio. All rights reserved. Copyright © Oracle. All rights reserved. Copyright © Adobe Systems Incorporated. All rights reserved. Copyright © DataArt, Inc. All rights reserved. Copyright © ComponentSource. All rights reserved. Copyright © Microsoft Corporation. All rights reserved. Copyright © Rogue Wave Software, Inc. All rights reserved. Copyright © Teradata Corporation. All rights reserved. Copyright © Yahoo! Inc. All rights reserved. Copyright © Glyph & Cog, LLC. All rights reserved. Copyright © Thinkmap, Inc. All rights reserved. Copyright © Clearpace Software Limited. All rights reserved. Copyright © Information Builders, Inc. All rights reserved. Copyright © OSS Nokalva, Inc. All rights reserved. Copyright Edifecs, Inc. All rights reserved. Copyright Cleo Communications, Inc. All rights reserved. Copyright © International Organization for Standardization 1986. All rights reserved. Copyright © ej-technologies GmbH. All rights reserved. Copyright © Jaspersoft Corporation. All rights reserved. Copyright © International Business Machines Corporation. All rights reserved. Copyright © yWorks GmbH. All rights reserved. Copyright © Lucent Technologies. All rights reserved. Copyright © University of Toronto. All rights reserved. Copyright © Daniel Veillard. All rights reserved. Copyright © Unicode, Inc. Copyright IBM Corp. All rights reserved. Copyright © MicroQuill Software Publishing, Inc. All rights reserved. Copyright © PassMark Software Pty Ltd. All rights reserved. Copyright © LogiXML, Inc. All rights reserved. Copyright © 2003-2010 Lorenzi Davide, All rights reserved. Copyright © Red Hat, Inc. All rights reserved. Copyright © The Board of Trustees of the Leland Stanford Junior University. All rights reserved. Copyright © EMC Corporation. All rights reserved. Copyright © Flexera Software. All rights reserved. Copyright © Jinfonet Software. All rights reserved. Copyright © Apple Inc. All rights reserved. Copyright © Telerik Inc. All rights reserved. Copyright © BEA Systems. All rights reserved. Copyright © PDFlib GmbH. All rights reserved. Copyright © Orientation in Objects GmbH. All rights reserved. Copyright © Tanuki Software, Ltd. All rights reserved. Copyright © Ricebridge. All rights reserved. Copyright © Sencha, Inc. All rights reserved. Copyright © Scalable Systems, Inc. All rights reserved. Copyright © jqWidgets. All rights reserved. Copyright © Tableau Software, Inc. All rights reserved. Copyright © MaxMind, Inc. All Rights Reserved. Copyright © TMatte Software s.r.o. All rights reserved. Copyright © MapR Technologies Inc. All rights reserved. Copyright © Amazon Corporate LLC. All rights reserved. Copyright © Highsoft. All rights reserved. Copyright © Python Software Foundation. All rights reserved. Copyright © BeOpen.com. All rights reserved. Copyright © CNRI. All rights reserved.

This product includes software developed by the Apache Software Foundation (<http://www.apache.org/>), and/or other software which is licensed under various versions of the Apache License (the "License"). You may obtain a copy of these Licenses at <http://www.apache.org/licenses/>. Unless required by applicable law or agreed to in writing, software distributed under these Licenses is distributed on an "AS IS" BASIS, WITHOUT WARRANTIES OR CONDITIONS OF ANY KIND, either express or implied. See the Licenses for the specific language governing permissions and limitations under the Licenses.

This product includes software which was developed by Mozilla (<http://www.mozilla.org/>), software copyright The JBoss Group, LLC, all rights reserved; software copyright © 1999-2006 by Bruno Lowagie and Paulo Soares and other software which is licensed under various versions of the GNU Lesser General Public License Agreement, which may be found at <http://www.gnu.org/licenses/lgpl.html>. The materials are provided free of charge by Informatica, "as-is", without warranty of any kind, either express or implied, including but not limited to the implied warranties of merchantability and fitness for a particular purpose.

The product includes ACE(TM) and TAO(TM) software copyrighted by Douglas C. Schmidt and his research group at Washington University, University of California, Irvine, and Vanderbilt University, Copyright (©) 1993-2006, all rights reserved.

This product includes software developed by the OpenSSL Project for use in the OpenSSL Toolkit (copyright The OpenSSL Project. All Rights Reserved) and redistribution of this software is subject to terms available at <http://www.openssl.org> and <http://www.openssl.org/source/license.html>.

This product includes Curl software which is Copyright 1996-2013, Daniel Stenberg, <daniel@haxx.se>. All Rights Reserved. Permissions and limitations regarding this software are subject to terms available at <http://curl.haxx.se/docs/copyright.html>. Permission to use, copy, modify, and distribute this software for any purpose with or without fee is hereby granted, provided that the above copyright notice and this permission notice appear in all copies.

The product includes software copyright 2001-2005 (©) MetaStuff, Ltd. All Rights Reserved. Permissions and limitations regarding this software are subject to terms available at <http://www.dom4j.org/license.html>.

This product includes software copyright © 1996-2006 Per Bothner. All rights reserved. Your right to use such materials is set forth in the license which may be found at <http://www.gnu.org/software/kawa/Software-License.html>.

This product includes OSSP UUID software which is Copyright © 2002 Ralf S. Engelschall, Copyright © 2002 The OSSP Project Copyright © 2002 Cable & Wireless Deutschland. Permissions and limitations regarding this software are subject to terms available at <http://www.opensource.org/licenses/mit-license.php>.

This product includes software developed by Boost (<http://www.boost.org/>) or under the Boost software license. Permissions and limitations regarding this software are subject to terms available at http://www.boost.org/LICENSE_1_0.txt.

This product includes software copyright © 1997-2007 University of Cambridge. Permissions and limitations regarding this software are subject to terms available at <http://www.pcre.org/license.txt>.

This product includes software copyright © 2007 The Eclipse Foundation. All Rights Reserved. Permissions and limitations regarding this software are subject to terms available at <http://www.eclipse.org/org/documents/epl-v10.php> and at <http://www.eclipse.org/org/documents/edl-v10.php>.

This product includes software licensed under the terms at <http://www.tcl.tk/software/tcltk/license.html>, <http://www.bosrup.com/web/overlib?License>, <http://www.stlport.org/doc/license.html>, <http://asm.ow2.org/license.html>, <http://www.cryptix.org/LICENSE.TXT>, <http://hsqldb.org/web/hsqldbLicense.html>, <http://httpunit.sourceforge.net/doc/license.html>, <http://jung.sourceforge.net/license.txt>, http://www.gzip.org/zlib/zlib_license.html, <http://www.openldap.org/software/release/license.html>, <http://www.libssh2.org>, <http://slf4j.org/license.html>, <http://www.sente.ch/software/OpenSourceLicense.html>, <http://fusesource.com/downloads/license-agreements/fuse-message-broker-v-5-3-license-agreement>, <http://antlr.org/license.html>, <http://aopalliance.sourceforge.net/>, <http://www.bouncycastle.org/license.html>, <http://www.jgraph.com/jgraphdownload.html>, <http://www.jcraft.com/jsch/LICENSE.txt>, http://jotm.objectweb.org/bsd_license.html, <http://www.w3.org/Consortium/Legal/2002/copyright-software-20021231>, <http://www.slf4j.org/license.html>, <http://nanoxml.sourceforge.net/orig/copyright.html>, <http://www.json.org/license.html>, <http://forge.ow2.org/projects/javaservice/>, <http://www.postgresql.org/about/license.html>, <http://www.sqlite.org/copyright.html>, <http://www.tcl.tk/software/tcltk/license.html>, <http://www.jaxen.org/faq.html>, <http://www.jdom.org/docs/faq.html>, <http://www.slf4j.org/license.html>, <http://www.iodbc.org/dataspace/iodbc/wiki/iODBC/License>, <http://www.keplerproject.org/md5/license.html>, <http://www.toedter.com/en/jcalendar/license.html>, <http://www.edankert.com/bounce/index.html>, <http://www.net-snmp.org/about/license.html>, <http://www.openmdx.org/#FAQ>, http://www.php.net/license/3_01.txt, <http://srp.stanford.edu/license.txt>, <http://www.schneider.com/blowfish.html>, <http://www.jmock.org/license.html>, <http://xsom.java.net>, <http://benalman.com/about/license/>, <https://github.com/CreateJS/EaselJS/blob/master/src/easeljs/display/Bitmap.js>, <http://www.h2database.com/html/license.html#summary>, <http://jsoncpp.sourceforge.net/LICENSE>, <http://jdbc.postgresql.org/license.html>, <http://protobuf.googlecode.com/svn/trunk/src/google/protobuf/descriptor.proto>, <https://github.com/rantav/hector/blob/master/LICENSE>, <http://web.mit.edu/Kerberos/krb5-current/doc/mitK5license.html>, <http://jibx.sourceforge.net/jibx-license.html>, <https://github.com/lyokato/libgeohash/blob/master/LICENSE>, <https://github.com/hjiang/jsonxx/blob/master/LICENSE>, <https://code.google.com/p/lz4/>, <https://github.com/jedisct1/libsodium/blob/master/>

LICENSE; <http://one-jar.sourceforge.net/index.php?page=documents&file=license>; <https://github.com/EsotericSoftware/kryo/blob/master/license.txt>; <http://www.scala-lang.org/license.html>; <https://github.com/tinkerpop/blueprints/blob/master/LICENSE.txt>; <http://gee.cs.oswego.edu/dl/classes/EDU/oswego/cs/dl/util/concurrent/intro.html>; <https://aws.amazon.com/asl/>; <https://github.com/twbs/bootstrap/blob/master/LICENSE>; <https://sourceforge.net/p/xmlunit/code/HEAD/tree/trunk/LICENSE.txt>; <https://github.com/documentcloud/underscore-contrib/blob/master/LICENSE>, and <https://github.com/apache/hbase/blob/master/LICENSE.txt>.

This product includes software licensed under the Academic Free License (<http://www.opensource.org/licenses/afl-3.0.php>), the Common Development and Distribution License (<http://www.opensource.org/licenses/cddl1.php>) the Common Public License (<http://www.opensource.org/licenses/cpl1.0.php>), the Sun Binary Code License Agreement Supplemental License Terms, the BSD License (<http://www.opensource.org/licenses/bsd-license.php>), the new BSD License (<http://opensource.org/licenses/BSD-3-Clause>), the MIT License (<http://www.opensource.org/licenses/mit-license.php>), the Artistic License (<http://www.opensource.org/licenses/artistic-license-1.0>) and the Initial Developer's Public License Version 1.0 (<http://www.firebirdsql.org/en/initial-developer-s-public-license-version-1-0/>).

This product includes software copyright © 2003-2006 Joe Walnes, 2006-2007 XStream Committers. All rights reserved. Permissions and limitations regarding this software are subject to terms available at <http://xstream.codehaus.org/license.html>. This product includes software developed by the Indiana University Extreme! Lab. For further information please visit <http://www.extreme.indiana.edu/>.

This product includes software Copyright (c) 2013 Frank Balluffi and Markus Moeller. All rights reserved. Permissions and limitations regarding this software are subject to terms of the MIT license.

See patents at <https://www.informatica.com/legal/patents.html>.

DISCLAIMER: Informatica LLC provides this documentation "as is" without warranty of any kind, either express or implied, including, but not limited to, the implied warranties of noninfringement, merchantability, or use for a particular purpose. Informatica LLC does not warrant that this software or documentation is error free. The information provided in this software or documentation may include technical inaccuracies or typographical errors. The information in this software and documentation is subject to change at any time without notice.

NOTICES

This Informatica product (the "Software") includes certain drivers (the "DataDirect Drivers") from DataDirect Technologies, an operating company of Progress Software Corporation ("DataDirect") which are subject to the following terms and conditions:

1. THE DATADIRECT DRIVERS ARE PROVIDED "AS IS" WITHOUT WARRANTY OF ANY KIND, EITHER EXPRESSED OR IMPLIED, INCLUDING BUT NOT LIMITED TO, THE IMPLIED WARRANTIES OF MERCHANTABILITY, FITNESS FOR A PARTICULAR PURPOSE AND NON-INFRINGEMENT.
2. IN NO EVENT WILL DATADIRECT OR ITS THIRD PARTY SUPPLIERS BE LIABLE TO THE END-USER CUSTOMER FOR ANY DIRECT, INDIRECT, INCIDENTAL, SPECIAL, CONSEQUENTIAL OR OTHER DAMAGES ARISING OUT OF THE USE OF THE ODBC DRIVERS, WHETHER OR NOT INFORMED OF THE POSSIBILITIES OF DAMAGES IN ADVANCE. THESE LIMITATIONS APPLY TO ALL CAUSES OF ACTION, INCLUDING, WITHOUT LIMITATION, BREACH OF CONTRACT, BREACH OF WARRANTY, NEGLIGENCE, STRICT LIABILITY, MISREPRESENTATION AND OTHER TORTS.

The information in this documentation is subject to change without notice. If you find any problems in this documentation, report them to us at infa_documentation@informatica.com.

Informatica products are warranted according to the terms and conditions of the agreements under which they are provided. INFORMATICA PROVIDES THE INFORMATION IN THIS DOCUMENT "AS IS" WITHOUT WARRANTY OF ANY KIND, EXPRESS OR IMPLIED, INCLUDING WITHOUT ANY WARRANTIES OF MERCHANTABILITY, FITNESS FOR A PARTICULAR PURPOSE AND ANY WARRANTY OR CONDITION OF NON-INFRINGEMENT.

Publication Date: 2022-07-27

Table of Contents

Preface	22
Informatica Resources.	22
Informatica Network.	22
Informatica Knowledge Base.	22
Informatica Documentation.	23
Informatica Product Availability Matrices.	23
Informatica Velocity.	23
Informatica Marketplace.	23
Informatica Global Customer Support.	23
Chapter 1: Working with Transformations.....	24
Transformations Overview.	24
Active Transformations.	24
Passive Transformations.	25
Unconnected Transformations.	25
Native and Non-native Transformations.	25
Transformation Descriptions.	26
Creating a Transformation.	28
Configuring Transformations.	29
Renaming Transformations.	29
Transformation Ports.	29
Create Ports.	29
Configure Ports.	30
Linking Ports.	30
Multi-Group Transformations.	30
Working with Expressions.	31
Using the Expression Editor.	32
Evaluate Expressions.	34
Evaluating an Expression.	35
Evaluate Expression Restrictions.	35
Local Variables.	35
Temporarily Store Data and Simplify Complex Expressions.	36
Store Values Across Rows.	36
Capture Values from Stored Procedures.	37
Guidelines for Configuring Variable Ports.	37
Default Values for Ports.	38
User-Defined Default Values.	39
User-Defined Default Input Values.	40
User-Defined Default Output Values.	42
General Rules for Default Values.	44

Default Value Validation.	44
Configuring Tracing Level in Transformations.	44
Reusable Transformations.	45
Instances and Inherited Changes.	46
Mapping Variables in Expressions.	46
Creating Reusable Transformations.	46
Promoting Non-Reusable Transformations.	47
Creating Non-Reusable Instances of Reusable Transformations.	47
Adding Reusable Transformations to Mappings.	47
Modifying a Reusable Transformation.	48
Chapter 2: Aggregator Transformation.	49
Aggregator Transformation Overview.	49
Components of the Aggregator Transformation.	50
Configuring Aggregator Transformation Properties.	50
Configuring Aggregator Transformation Ports.	51
Configuring Aggregate Caches.	51
Aggregate Expressions.	52
Aggregate Functions.	52
Nested Aggregate Functions.	52
Conditional clauses.	53
Non-Aggregate Functions.	53
Null Values in Aggregate Functions.	53
Group By Ports.	53
Non-Aggregate Expressions.	55
Default Values.	55
Using Sorted Input.	55
Sorted Input Conditions.	55
Sorting Data.	56
Creating an Aggregator Transformation.	57
Tips for Aggregator Transformations.	57
Troubleshooting Aggregator Transformations.	58
Chapter 3: Custom Transformation.	59
Custom Transformation Overview.	59
Working with Transformations Built On the Custom Transformation.	60
Code Page Compatibility.	60
Distributing Custom Transformation Procedures.	61
Creating Custom Transformations.	61
Rules and Guidelines for Custom Transformations.	61
Custom Transformation Components.	62
Working with Groups and Ports.	62
Creating Groups and Ports.	62

Editing Groups and Ports	63
Defining Port Relationships.	63
Working with Port Attributes.	64
Editing Port Attribute Values.	64
Custom Transformation Properties.	64
Setting the Update Strategy.	66
Working with Thread-Specific Procedure Code	66
Working with Transaction Control.	67
Transformation Scope.	67
Generate Transaction.	67
Working with Transaction Boundaries.	68
Blocking Input Data.	68
Writing the Procedure Code to Block Data.	69
Configuring Custom Transformations as Blocking Transformations.	69
Validating Mappings with Custom Transformations.	69
Working with Procedure Properties.	70
Creating Custom Transformation Procedures.	70
Step 1. Create the Custom Transformation.	71
Step 2. Generate the C Files.	73
Step 3. Fill Out the Code with the Transformation Logic.	74
Step 4. Build the Module.	79
Step 5. Create a Mapping.	81
Step 6. Run the Session in a Workflow.	81
Chapter 4: Custom Transformation Functions.	82
Custom Transformation Functions Overview.	82
Working with Handles.	82
Function Reference.	83
Working with Rows.	86
Rules and Guidelines for Row-Based and Array-Based Data Access Mode.	87
Generated Functions.	87
Initialization Functions.	88
Notification Functions.	89
Deinitialization Functions.	91
API Functions.	92
Set Data Access Mode Function.	93
Navigation Functions.	94
Property Functions.	96
Rebind Datatype Functions.	103
Data Handling Functions (Row-Based Mode).	105
Set Pass-Through Port Function	107
Output Notification Function.	108
Data Boundary Output Notification Function.	109

Error Functions.	109
Session Log Message Functions.	109
Increment Error Count Function.	110
Is Terminated Function.	111
Blocking Functions.	111
Pointer Functions.	112
Change String Mode Function.	113
Set Data Code Page Function.	113
Row Strategy Functions (Row-Based Mode).	114
Change Default Row Strategy Function.	115
Array-Based API Functions.	116
Maximum Number of Rows Functions.	116
Number of Rows Functions.	117
Is Row Valid Function.	118
Data Handling Functions (Array-Based Mode).	119
Row Strategy Functions (Array-Based Mode).	121
Set Input Error Row Functions.	122
Chapter 5: Data Masking Transformation.	125
Data Masking transformation.	125
Masking Properties.	126
Locale.	126
Masking Types.	126
Repeatable Output.	127
Seed.	127
Mapping Parameters.	127
Associated O/P.	128
Key Masking.	128
Masking String Values.	128
Masking Numeric Values.	129
Masking Datetime Values.	130
Substitution Masking.	130
Dictionaries.	130
Storage Tables.	131
Substitution Masking Properties.	132
Relational Dictionary.	133
Connection Requirements.	133
Rules and Guidelines for Substitution Masking.	133
Dependent Masking.	134
Dependent Masking Example.	134
Repeatable Dependent Masking.	135
Random Masking.	135
Masking Numeric Values.	136

Masking String Values.	136
Masking Date Values	136
Applying Masking Rules.	137
Mask Format.	137
Source String Characters.	138
Result String Replacement Characters.	139
Range.	139
Blurring.	140
Expression Masking.	141
Repeatable Expression Masking.	141
Rules and Guidelines for Expression Masking.	142
Format Preserving Encryption.	143
Special Mask Formats.	144
Social Security Number Masking.	144
Social Security Number Format.	144
Area Code Requirement.	144
Repeatable Social Security Number Masking.	145
Credit Card Number Masking.	145
Phone Number Masking.	145
Email Address Masking.	146
Advanced Email Masking.	146
Social Insurance Number Masking.	147
SIN Start Digit.	148
Repeatable SIN Numbers.	148
IP Address Masking.	148
URL Address Masking.	148
Default Value File.	149
Data Masking Transformation Session Properties.	149
Rules and Guidelines for Data Masking Transformations.	150
Chapter 6: Data Masking Examples.	151
Name and Address Lookup Files.	151
Substituting Data with the Lookup Transformation.	151
Masking Data with an Expression Transformation.	154
Chapter 7: Expression Transformation.	157
Expression Transformation Overview.	157
Expression Transformation Components.	157
Configuring Ports.	158
Calculating Values.	158
Creating an Expression Transformation.	159

Chapter 8: External Procedure Transformation.....	160
External Procedure Transformation Overview.	160
Code Page Compatibility.	161
External Procedures and External Procedure Transformations.	161
External Procedure Transformation Properties.	161
COM Versus Informatica External Procedures.	162
The BankSoft Example.	162
Configuring External Procedure Transformation Properties.	162
Developing COM Procedures.	164
Steps for Creating a COM Procedure.	164
COM External Procedure Server Type.	164
Using Visual C++ to Develop COM Procedures.	165
Developing COM Procedures with Visual Basic.	170
Developing Informatica External Procedures.	171
Step 1. Create the External Procedure Transformation.	172
Step 2. Generate the C++ Files.	174
Step 3. Fill Out the Method Stub with Implementation.	176
Step 4. Building the Module.	177
Step 5. Create a Mapping.	178
Step 6. Run the Session.	178
Distributing External Procedures.	179
Distributing COM Procedures.	179
Distributing Informatica Modules.	180
Development Notes.	180
COM Datatypes.	180
Row-Level Procedures.	181
Return Values from Procedures.	181
Exceptions in Procedure Calls.	182
Memory Management for Procedures.	182
Wrapper Classes for Pre-Existing C/C++ Libraries or VB Functions.	182
Generating Error and Tracing Messages.	182
Unconnected External Procedure Transformations.	184
Initializing COM and Informatica Modules.	185
Other Files Distributed and Used in TX.	186
Service Process Variables in Initialization Properties.	187
External Procedure Interfaces.	187
Dispatch Function.	188
External Procedure Function.	188
Property Access Functions.	188
Parameter Access Functions.	189
Code Page Access Functions.	191

Transformation Name Access Functions.	191
Procedure Access Functions.	192
Partition Related Functions.	192
Tracing Level Function.	192
Chapter 9: Filter Transformation.	194
Filter Transformation Overview.	194
Filter Transformation Components.	195
Configuring Filter Transformation Ports.	195
Filter Condition.	195
Filtering Rows with Null Values.	196
Steps to Create a Filter Transformation.	196
Tips for Filter Transformations.	196
Chapter 10: HTTP Transformation.	198
HTTP Transformation Overview.	198
Authentication.	199
Connecting to the HTTP Server.	199
Creating an HTTP Transformation.	199
Configuring the Properties Tab.	200
Configuring the HTTP Tab.	201
Selecting a Method.	201
Configuring Groups and Ports.	201
Configuring a URL.	205
Examples.	207
GET Example.	207
POST Example.	208
SIMPLE POST Example.	209
SIMPLE PATCH Example.	210
SIMPLE PUT Example.	211
SIMPLE DELETE Example.	212
Chapter 11: Identity Resolution Transformation	214
Identity Resolution Transformation Overview.	214
Create and Configure the Transformation.	214
Search Server Connection.	215
System and Search Configuration.	215
View Selection.	216
Identity Resolution Transformation Tabs	217
Groups and Ports.	217
Input Groups and Ports	218
Output Groups and Ports.	218

Chapter 12: Java Transformation.....	219
Java Transformation Overview.	219
Steps to Define a Java Transformation.	220
Active and Passive Java Transformations.	220
Data Type Conversion.	220
Using the Java Code Tab.	221
Configuring Ports.	222
Creating Groups and Ports.	222
Setting Default Port Values.	223
Configuring Java Transformation Properties.	224
Working with Transaction Control.	225
Setting the Update Strategy.	226
Developing Java Code.	226
Creating Java Code Snippets.	227
Importing Java Packages.	227
Defining Helper Code.	227
On Input Row Tab.	228
On End of Data Tab.	229
On Receiving Transaction Tab.	229
Using Java Code to Parse a Flat File.	229
Configuring Java Transformation Settings.	230
Configuring the Classpath.	230
Enabling High Precision.	232
Processing Subseconds.	232
Compiling a Java Transformation.	232
Fixing Compilation Errors.	233
Locating the Source of Compilation Errors.	233
Identifying the Source of Compilation Errors.	233
 Chapter 13: Java Transformation API Reference.....	 235
Java Transformation API Methods Overview.	235
commit.	236
failSession.	237
generateRow.	237
getInRowType.	238
getMetadata.	238
incrementErrorCount.	239
isNull.	240
logError.	240
logInfo.	241
rollback.	241
setNull.	242

setOutRowType.	242
storeMetadata.	243
Chapter 14: Java Expressions.	245
Java Expressions Overview.	245
Expression Function Types.	246
Using the Define Expression Dialog Box to Define an Expression.	246
Step 1. Configure the Function.	247
Step 2. Create and Validate the Expression.	247
Step 3. Generate Java Code for the Expression.	247
Creating an Expression and Generating Java Code by Using the Define Expression Dialog Box	247
Java Expression Templates.	248
Working with the Simple Interface.	248
invokeJExpression.	248
Simple Interface Example.	249
Working with the Advanced Interface.	250
Invoking an Expression with the Advanced Interface.	250
Rules and Guidelines for Working with the Advanced Interface.	250
EDatatype Class.	251
JExprParamMetadata Class.	251
defineJExpression.	252
JExpression Class.	253
Advanced Interface Example.	253
JExpression Class API Reference.	254
getBytes.	254
getDouble.	255
getInt.	255
getLong.	255
getResultDataType.	255
getResultMetadata.	255
getStringBuffer.	256
invoke.	256
isResultNull.	256
Chapter 15: Java Transformation Example.	258
Java Transformation Example Overview.	258
Step 1. Import the Mapping.	259
Step 2. Create Transformation and Configure Ports.	259
Step 3. Enter Java Code.	260
Import Packages Tab.	260
Helper Code Tab.	261
On Input Row Tab.	261
Step 4. Compile the Java Code.	263

Step 5. Create a Session and Workflow.	263
Sample Data.	263
Chapter 16: Joiner Transformation.	265
Joiner Transformation Overview.	265
Working with the Joiner Transformation.	266
Joiner Transformation Properties.	266
Defining a Join Condition.	267
Defining the Join Type.	268
Normal Join.	268
Master Outer Join.	269
Detail Outer Join.	270
Full Outer Join.	270
Using Sorted Input.	270
Configuring the Sort Order.	271
Adding Transformations to the Mapping.	271
Configuring the Joiner Transformation.	272
Defining the Join Condition.	272
Joining Data from a Single Source.	273
Joining Two Branches of the Same Pipeline.	273
Joining Two Instances of the Same Source.	274
Guidelines for Joining Data from a Single Source.	274
Blocking the Source Pipelines.	275
Unsorted Joiner Transformation.	275
Sorted Joiner Transformation.	275
Working with Transactions.	275
Preserving Transaction Boundaries for a Single Pipeline.	276
Preserving Transaction Boundaries in the Detail Pipeline.	277
Dropping Transaction Boundaries for Two Pipelines.	277
Creating a Joiner Transformation.	277
Tips for Joiner Transformations.	278
Chapter 17: Lookup Transformation.	280
Lookup Transformation Overview.	280
Lookup Source Types.	281
Relational Lookups.	281
Flat File Lookups.	281
Pipeline Lookups.	283
Connected and Unconnected Lookups.	284
Connected Lookups.	285
Unconnected Lookups.	285
Lookup Components.	286
Lookup Source.	286

Lookup Ports.	286
Lookup Properties.	287
Lookup Condition.	287
Lookup Properties.	288
Configuring Lookup Properties in a Session.	292
Lookup Query.	294
Default Lookup Query.	294
Overriding the Lookup Query.	294
SQL Override for Uncached Lookup.	296
Lookup Source Filter.	297
Lookup Condition.	297
Uncached or Static Cache.	298
Dynamic Cache.	299
Handling Multiple Matches.	299
Lookup Caches.	299
Return Multiple Rows.	300
Rules and Guidelines for Returning Multiple Rows.	300
Configuring Unconnected Lookup Transformations.	301
Step 1. Add Input Ports.	301
Step 2. Add the Lookup Condition.	301
Step 3. Designate a Return Value.	302
Step 4. Call the Lookup Through an Expression.	302
Database Deadlock Resilience.	303
Creating a Lookup Transformation.	303
Creating a Reusable Pipeline Lookup Transformation.	304
Creating a Non-Reusable Pipeline Lookup Transformation.	305
Tips for Lookup Transformations.	305
Chapter 18: Lookup Caches.	307
Lookup Caches Overview.	307
Cache Comparison.	309
Building Connected Lookup Caches.	309
Sequential Caches.	309
Concurrent Caches.	310
Using a Persistent Lookup Cache.	311
Using a Non-Persistent Cache.	311
Using a Persistent Cache.	311
Rebuilding the Lookup Cache.	311
Working with an Uncached Lookup or Static Cache.	312
Sharing the Lookup Cache.	313
Sharing an Unnamed Lookup Cache.	313
Sharing a Named Lookup Cache.	315
Tips for Lookup Caches.	319

Chapter 19: Dynamic Lookup Cache.....	320
Dynamic Lookup Cache Overview.	320
Dynamic Lookup Properties.	321
NewLookupRows.	322
Associated Expression.	322
Null Values.	323
Ignore Ports in Comparison.	324
SQL Override.	325
Lookup Transformation Values.	325
Initial Cache Values.	326
Input Values.	326
Lookup Values.	326
Output Values.	327
Dynamic Lookup Cache Updates.	328
Insert Else Update.	328
Update Else Insert.	329
Mappings with Dynamic Lookups.	330
Configuring the Upstream Update Strategy Transformation.	330
Configuring Downstream Transformations.	331
Configuring Sessions with a Dynamic Lookup Cache.	332
Conditional Dynamic Cache Updates.	332
Session Processing.	333
Configuring a Conditional Dynamic Cache Lookup.	333
Dynamic Cache Update with Expression Results.	333
Null Expression Values.	334
Session Processing.	334
Configuring an Expression for Dynamic Cache Updates.	334
Synchronizing Cache with the Lookup Source.	335
NewLookupRow.	335
Configuring Dynamic Cache Synchronization.	336
Dynamic Lookup Cache Example.	336
Rules and Guidelines for Dynamic Lookup Caches.	337
Chapter 20: Normalizer Transformation.....	338
Normalizer Transformation Overview.	338
Normalizer Transformation Components.	339
Ports Tab.	339
Properties Tab.	340
Normalizer Tab.	340
Normalizer Transformation Generated Keys.	342
Storing Generated Key Values.	342
Changing the Generated Key Values.	342

VSAM Normalizer Transformation.	342
VSAM Normalizer Ports Tab.	344
VSAM Normalizer Tab.	345
Steps to Create a VSAM Normalizer Transformation.	346
Pipeline Normalizer Transformation.	347
Pipeline Normalizer Ports Tab.	348
Pipeline Normalizer Tab.	349
Steps to Create a Pipeline Normalizer Transformation.	350
Using a Normalizer Transformation in a Mapping.	351
Generating Key Values.	353
Troubleshooting Normalizer Transformations.	354
Chapter 21: Rank Transformation.	356
Rank Transformation Overview.	356
Ranking String Values.	357
Rank Caches.	357
Rank Transformation Properties.	357
Ports in a Rank Transformation.	357
Rank Index.	358
Defining Groups.	358
Creating a Rank Transformation.	359
Chapter 22: Router Transformation.	361
Router Transformation Overview.	361
Working with Groups.	363
Input Group.	363
Output Groups.	363
Using Group Filter Conditions.	363
Adding Groups.	365
Working with Ports.	365
Connecting Router Transformations in a Mapping.	366
Creating a Router Transformation.	366
Chapter 23: Sequence Generator Transformation.	367
Sequence Generator Transformation Overview.	367
Sequence Generator Ports.	368
NEXTVAL Port.	368
CURRVAL.	370
Sequence Generator Transformation Properties.	371
Start Value.	373
Increment By.	373
End Value.	373
Cycle Through a Range of Values.	373

Current Value.	374
Number of Cached Values.	374
Non-Reusable Sequence Generators.	375
Reusable Sequence Generators.	375
Sequence Generator Advanced Properties.	376
Reset.	376
Creating a Sequence Generator Transformation.	376
Sequence Generator Transformation in a Non-native Environment.	377
Sequence Generator Transformation on the Blaze Engine.	377
Sequence Generator Transformation on the Spark Engine.	377
Chapter 24: Sorter Transformation.	378
Sorter Transformation Overview.	378
Sorting Data.	378
Sorter Transformation Properties.	379
Sorter Cache Size.	380
Case Sensitive.	380
Work Directory.	380
Distinct Output Rows.	380
Tracing Level.	381
Null Treated Low.	381
Transformation Scope.	381
Creating a Sorter Transformation.	381
Chapter 25: Source Qualifier Transformation.	383
Source Qualifier Transformation Overview.	383
Transformation Datatypes.	384
Target Load Order.	384
Datetime Values.	384
Parameters and Variables.	385
Source Qualifier Transformation Properties.	385
Default Query.	386
Viewing the Default Query.	387
Overriding the Default Query.	387
Joining Source Data.	388
Default Join.	388
Custom Joins.	389
Heterogeneous Joins.	389
Creating Key Relationships.	389
Adding an SQL Query.	390
Entering a User-Defined Join.	391
Outer Join Support.	392
Informatica Join Syntax.	392

Creating an Outer Join.	397
Common Database Syntax Restrictions.	398
Entering a Source Filter.	399
Using Sorted Ports.	400
Select Distinct.	401
Overriding Select Distinct in the Session.	401
Adding Pre- and Post-Session SQL Commands.	401
Creating a Source Qualifier Transformation.	402
Creating a Source Qualifier Transformation Manually.	402
Configuring Source Qualifier Transformation Options.	402
Troubleshooting Source Qualifier Transformations.	403
Chapter 26: SQL Transformation.	405
SQL Transformation Overview.	405
Script Mode.	406
Example.	406
Rules and Guidelines for Script Mode.	407
Query Mode.	407
Using Static SQL Queries.	408
Using Dynamic SQL Queries.	409
Pass-Through Ports Configuration.	411
Passive Mode Configuration.	411
Rules and Guidelines for Query Mode.	412
Connecting to Databases.	412
Using a Static Database Connection.	413
Passing a Logical Database Connection	413
Passing Full Connection Information.	413
Rules and Guidelines for Database Connections.	415
Session Processing.	416
Transaction Control.	416
High Availability.	417
SQL Query Log.	419
Input Row to Output Row Cardinality.	419
Query Statement Processing.	419
Number of Rows Affected.	420
Maximum Output Row Count.	421
Understanding Error Rows.	421
Continuing on SQL Error	423
SQL Transformation Properties.	423
Properties Tab.	423
SQL Settings Tab.	425
SQL Ports Tab.	425
SQL Statements.	426

Creating an SQL Transformation.	427
---	-----

Chapter 27: Using the SQL Transformation in a Mapping..... 429

SQL Transformation Example Overview.	429
Dynamic Update Example.	429
Defining the Source File.	430
Creating a Target Definition.	431
Creating the Database Table.	431
Configuring the Expression Transformation.	432
Defining the SQL Transformation.	432
Configuring Session Attributes.	434
Target Data Results.	434
Dynamic Connection Example.	434
Defining the Source File.	435
Creating a Target Definition.	435
Creating the Database Tables.	436
Creating the Database Connections.	436
Configuring the Expression Transformation.	436
Defining the SQL Transformation.	437
Configuring Session Attributes.	438
Target Data Results.	438

Chapter 28: Stored Procedure Transformation..... 439

Stored Procedure Transformation Overview.	439
Input and Output Data.	440
Connected and Unconnected.	441
Specifying when the Stored Procedure Runs.	442
Using a Stored Procedure in a Mapping.	443
Writing a Stored Procedure.	443
Sample Stored Procedure.	443
Creating a Stored Procedure Transformation.	445
Importing Stored Procedures.	446
Manually Creating Stored Procedure Transformations.	447
Setting Options for the Stored Procedure.	448
Changing the Stored Procedure.	449
Configuring a Connected Transformation.	449
Configuring an Unconnected Transformation.	450
Calling a Stored Procedure From an Expression.	450
Calling a Pre- or Post-Session Stored Procedure.	453
Error Handling.	454
Pre-Session Errors.	454
Post-Session Errors.	454
Session Errors.	455

Stored Procedure Options.	455
SQL Declaration.	455
Parameter Types.	455
Input/Output Port in Mapping.	455
Type of Return Value Supported.	456
Expression Rules.	456
Tips for Stored Procedure Transformations.	457
Troubleshooting Stored Procedure Transformations.	457
Chapter 29: Transaction Control Transformation.	458
Transaction Control Transformation Overview.	458
Transaction Control Transformation Properties.	459
Properties Tab.	459
Example.	460
Using Transaction Control Transformations in Mappings.	461
Sample Transaction Control Mappings with Multiple Targets.	461
Mapping Guidelines and Validation.	462
Creating a Transaction Control Transformation.	463
Chapter 30: Union Transformation.	464
Union Transformation Overview.	464
Rules and Guidelines for Union Transformations.	464
Union Transformation Components.	465
Working with Groups and Ports.	465
Creating a Union Transformation.	465
Using a Union Transformation in a Mapping.	466
Chapter 31: Unstructured Data Transformation.	467
Unstructured Data Transformation Overview.	467
Configuring the Unstructured Data Option.	468
Configuring the Data Transformation Repository Directory.	469
Data Transformation Service Types.	469
Unstructured Data Transformation Components.	469
Properties Tab.	470
UDT Settings Tab.	471
Viewing Status Tracing Messages.	472
Unstructured Data Transformation Ports.	472
Input and Output Types.	473
Additional Unstructured Data Transformation Ports.	474
Creating Ports From a Data Transformation Service.	474
Unstructured Data Transformation Service Names.	474
Relational Hierarchies.	475
Exporting the Hierarchy Schema.	475

Mappings.	476
Parsing Word Documents for Relational Tables.	476
Creating an Excel Sheet from XML.	477
Split XML File Output.	477
Rules and Guidelines for Unstructured Data Mappings.	478
Creating an Unstructured Data Transformation.	478
Chapter 32: Update Strategy Transformation.	480
Update Strategy Transformation Overview.	480
Setting the Update Strategy.	480
Flagging Rows Within a Mapping.	481
Forwarding Rejected Rows.	481
Update Strategy Expressions.	481
Aggregator and Update Strategy Transformations.	482
Lookup and Update Strategy Transformations.	482
Setting the Update Strategy for a Session.	483
Specifying an Operation for All Rows.	483
Specifying Operations for Individual Target Tables.	484
Update Strategy Checklist.	484
Chapter 33: XML Transformations.	486
XML Source Qualifier Transformation.	486
XML Parser Transformation.	486
XML Generator Transformation.	487
Index.	488

Preface

See the *PowerCenter® Transformation Guide* to learn about the configuration, guidelines, usage, and run-time behavior of Informatica transformations. Transformations are repository objects that represent the operations that the Integration Service performs on a data.

Refer the guide to perform data operations to generate, change, or transfer data. View the support for each transformation depending on where and how you plan to run the mapping. Data passes through the transformation ports to targets and other transformations that you link in a mapping or mapplet. You can enter expressions using the Expression Editor in the active transformations. A transformation can have multiple input and output groups, which is a set of ports that define a row of incoming or outgoing data.

Informatica Resources

Informatica provides you with a range of product resources through the Informatica Network and other online portals. Use the resources to get the most from your Informatica products and solutions and to learn from other Informatica users and subject matter experts.

Informatica Network

The Informatica Network is the gateway to many resources, including the Informatica Knowledge Base and Informatica Global Customer Support. To enter the Informatica Network, visit <https://network.informatica.com>.

As an Informatica Network member, you have the following options:

- Search the Knowledge Base for product resources.
- View product availability information.
- Create and review your support cases.
- Find your local Informatica User Group Network and collaborate with your peers.

Informatica Knowledge Base

Use the Informatica Knowledge Base to find product resources such as how-to articles, best practices, video tutorials, and answers to frequently asked questions.

To search the Knowledge Base, visit <https://search.informatica.com>. If you have questions, comments, or ideas about the Knowledge Base, contact the Informatica Knowledge Base team at KB_Feedback@informatica.com.

Informatica Documentation

Use the Informatica Documentation Portal to explore an extensive library of documentation for current and recent product releases. To explore the Documentation Portal, visit <https://docs.informatica.com>.

If you have questions, comments, or ideas about the product documentation, contact the Informatica Documentation team at infa_documentation@informatica.com.

Informatica Product Availability Matrices

Product Availability Matrices (PAMs) indicate the versions of the operating systems, databases, and types of data sources and targets that a product release supports. You can browse the Informatica PAMs at <https://network.informatica.com/community/informatica-network/product-availability-matrices>.

Informatica Velocity

Informatica Velocity is a collection of tips and best practices developed by Informatica Professional Services and based on real-world experiences from hundreds of data management projects. Informatica Velocity represents the collective knowledge of Informatica consultants who work with organizations around the world to plan, develop, deploy, and maintain successful data management solutions.

You can find Informatica Velocity resources at <http://velocity.informatica.com>. If you have questions, comments, or ideas about Informatica Velocity, contact Informatica Professional Services at ips@informatica.com.

Informatica Marketplace

The Informatica Marketplace is a forum where you can find solutions that extend and enhance your Informatica implementations. Leverage any of the hundreds of solutions from Informatica developers and partners on the Marketplace to improve your productivity and speed up time to implementation on your projects. You can find the Informatica Marketplace at <https://marketplace.informatica.com>.

Informatica Global Customer Support

You can contact a Global Support Center by telephone or through the Informatica Network.

To find your local Informatica Global Customer Support telephone number, visit the Informatica website at the following link:

<https://www.informatica.com/services-and-training/customer-success-services/contact-us.html>.

To find online support resources on the Informatica Network, visit <https://network.informatica.com> and select the eSupport option.

CHAPTER 1

Working with Transformations

This chapter includes the following topics:

- [Transformations Overview, 24](#)
- [Creating a Transformation, 28](#)
- [Configuring Transformations, 29](#)
- [Transformation Ports, 29](#)
- [Multi-Group Transformations, 30](#)
- [Working with Expressions, 31](#)
- [Local Variables, 35](#)
- [Default Values for Ports, 38](#)
- [Configuring Tracing Level in Transformations, 44](#)
- [Reusable Transformations, 45](#)

Transformations Overview

A transformation is a repository object that generates, modifies, or passes data. The Designer provides a set of transformations that perform specific functions. For example, an Aggregator transformation performs calculations on groups of data.

Transformations in a mapping represent the operations the Integration Service performs on the data. Data passes through transformation ports that you link in a mapping or maplet.

Transformations can be of the following types:

- Active or Passive
- Connected or Unconnected
- Native or Non-native

Active Transformations

An active transformation can perform any of the following actions:

- **Change the number of rows that pass through the transformation.** For example, the Filter transformation is active because it removes rows that do not meet the filter condition. All multi-group transformations are active because they might change the number of rows that pass through the transformation.

- **Change the transaction boundary.** For example, the Transaction Control transformation is active because it defines a commit or roll back transaction based on an expression evaluated for each row.
- **Change the row type.** For example, the Update Strategy transformation is active because it flags rows for insert, delete, update, or reject.

The Designer does not allow you to connect multiple active transformations or an active and a passive transformation to the same downstream transformation or transformation input group because the Integration Service may not be able to concatenate the rows passed by active transformations. For example, one branch in a mapping contains an Update Strategy transformation that flags a row for delete. Another branch contains an Update Strategy transformation that flags a row for insert. If you connect these transformations to a single transformation input group, the Integration Service cannot combine the delete and insert operations for the row.

The Sequence Generator transformation is an exception to the rule. The Designer does allow you to connect a Sequence Generator transformation and an active transformation to the same downstream transformation or transformation input group. A Sequence Generator transformation does not receive data. It generates unique numeric values. As a result, the Integration Service does not encounter problems concatenating rows passed by a Sequence Generator transformation and an active transformation.

Passive Transformations

A passive transformation does not change the number of rows that pass through the transformation, maintains the transaction boundary, and maintains the row type.

You can connect multiple transformations to the same downstream transformation or to the same transformation input group when all transformations in the upstream branches are passive. The transformation that originates the branch can be active or passive.

Unconnected Transformations

Transformations can be connected to the data flow, or they can be unconnected. An unconnected transformation is not connected to other transformations in the mapping. An unconnected transformation is called within another transformation, and returns a value to that transformation.

Native and Non-native Transformations

Native transformations are a set of transformations that the Designer provides. Non-native transformations are transformations that you create using the Custom transformation. The Designer also provides some non-native transformations such as Java, SQL, and Union transformations. Rules that apply to Custom transformations also apply to non-native transformations that are built using the Custom transformation.

Transformation Descriptions

The following table provides a brief description of each transformation:

Transformation	Type	Description
Aggregator	- Active - Connected - Native	Performs aggregate calculations.
Application Source Qualifier	- Active - Connected - Non-native	Represents the rows that the Integration Service reads from an application, such as an ERP source, when it runs a session.
Custom	- Active or Passive - Connected - Non-native	Calls a procedure in a shared library or DLL.
Data Masking	- Passive - Connected - Non-native	Replaces sensitive production data with realistic test data for non-production environments.
Expression	- Passive - Connected - Native	Calculates a value.
External Procedure	- Passive - Connected or Unconnected - Native	Calls a procedure in a shared library or in the COM layer of Windows.
Filter	- Active - Connected - Native	Filters data.
HTTP	- Passive - Connected - Non-native	Connects to an HTTP server to read or update data.
Input	- Passive - Connected - Native	Defines mapplet input rows. Available in the Mapplet Designer.
Java	- Active or Passive - Connected - Non-native	Executes user logic coded in Java. The byte code for the user logic is stored in the repository.
Joiner	- Active - Connected - Native	Joins data from different databases or flat file systems.
Lookup	- Active or Passive - Connected or Unconnected - Native	Look up and return data from a flat file, relational table, view, or synonym.

Transformation	Type	Description
Normalizer	- Active - Connected - Native	Source qualifier for COBOL sources. Can also use in the pipeline to normalize data from relational or flat file sources.
Output	- Passive - Connected - Native	Defines mapplet output rows. Available in the Mapplet Designer.
Rank	- Active - Connected - Native	Limits records to a top or bottom range.
Router	- Active - Connected - Native	Routes data into multiple transformations based on group conditions.
Sequence Generator	- Passive - Connected - Native	Generates primary keys.
Sorter	- Active - Connected - Native	Sorts data based on a sort key.
Source Qualifier	- Active - Connected - Native	Represents the rows that the Integration Service reads from a relational or flat file source when it runs a session.
SQL	- Active or Passive - Connected - Non-native	Executes SQL queries against a database.
Stored Procedure	- Passive - Connected or Unconnected - Native	Calls a stored procedure.
Transaction Control	- Active - Connected - Native	Defines commit and rollback transactions.
Union	- Active - Connected - Non-native	Merges data from different databases or flat file systems.
Unstructured Data	- Active or Passive - Connected - Non-native	Transforms data in unstructured and semi-structured formats.
Update Strategy	- Active - Connected - Native	Determines whether to insert, delete, update, or reject rows.

Transformation	Type	Description
XML Generator	- Active - Connected - Native	Reads data from one or more input ports and outputs XML through a single output port.
XML Parser	- Active - Connected - Native	Reads XML from one input port and outputs data to one or more output ports.
XML Source Qualifier	- Active - Connected - Native	Represents the rows that the Integration Service reads from an XML source when it runs a session.

When you build a mapping, you add transformations and configure them to handle data according to a business purpose. Complete the following tasks to incorporate a transformation into a mapping:

1. **Create the transformation.** Create it in the Mapping Designer as part of a mapping, in the Mapplet Designer as part of a mapplet, or in the Transformation Developer as a reusable transformation.
2. **Configure the transformation.** Each type of transformation has a unique set of options that you can configure.
3. **Link the transformation to other transformations and target definitions.** Drag one port to another to link them in the mapping or mapplet.

Creating a Transformation

You can create transformations using the following Designer tools:

- **Mapping Designer.** Create transformations that connect sources to targets. Transformations in a mapping cannot be used in other mappings unless you configure them to be reusable.
- **Transformation Developer.** Create individual transformations, called reusable transformations, that use in multiple mappings.
- **Mapplet Designer.** Create and configure a set of transformations, called mapplets, that you use in multiple mappings.

Use the same process to create a transformation in the Mapping Designer, Transformation Developer, and Mapplet Designer.

To create a transformation:

1. Open the appropriate Designer tool.
2. In the Mapping Designer, open or create a Mapping. In the Mapplet Designer, open or create a Mapplet.
3. Click Transformation > Create and select the type of transformation you want to create.
4. Drag across the portion of the mapping where you want to place the transformation.

The new transformation appears in the workspace. Next, you need to configure the transformation by adding any new ports to it and setting other properties.

Configuring Transformations

After you create a transformation, you can configure it. Every transformation contains the following common tabs:

- **Transformation.** Name the transformation or add a description.
- **Port.** Add and configure ports.
- **Properties.** Configure properties that are unique to the transformation.

Some transformations might include other tabs, such as the Condition tab, where you enter conditions in a Joiner or Normalizer transformation.

When you configure transformations, you might complete the following tasks:

- **Add ports.** Define the columns of data that move into and out of the transformation.
- **Add groups.** In some transformations, define input or output groups that define a row of data entering or leaving the transformation.
- **Enter expressions.** Enter SQL-like expressions in some transformations that transform the data.
- **Define local variables.** Define local variables in some transformations that temporarily store data.
- **Override default values.** Configure default values for ports to handle input nulls and output transformation errors.
- **Enter tracing levels.** Choose the amount of detail the Integration Service writes in the session log about a transformation.

Renaming Transformations

To rename transformations, click the Rename button and enter a descriptive name for the transformation, and click OK.

Transformation Ports

After you create a transformation, define the ports. Create the ports and define the port properties.

When you create some transformations, you do not have to create all of the ports manually. For example, you might create a Lookup transformation and reference a lookup table. If you view the transformation ports, you can see that the transformation has an output port for each column in the table that you referenced. You do not need to define those ports.

Create Ports

When you create some transformations, you do not have to create all of the ports manually. For example, you might create a Lookup transformation and reference a lookup table. If you view the transformation ports, you can see that the transformation has an output port for each column in the table that you referenced. You do not need to define those ports.

Create a port in the following ways:

- **Drag a port from another transformation.** When you drag a port from another transformation the Designer creates a port with the same properties, and it links the two ports. Click Layout > Copy Columns to enable copying ports.

- **Click the Add button on the Ports tab.** The Designer creates an empty port you can configure.

Configure Ports

When you define the transformation ports, you define port properties. Port properties include the port name, the data type, the port type, and the default value.

Configure the following port properties:

- **Port name.** The name of the port. Use the following conventions while naming ports:
 - Begin with a single- or double-byte letter or single- or double-byte underscore (_).
 - Port names can contain any of the following single- or double-byte characters: a letter, number, underscore (_), \$, #, or @.
- **Datatype, precision, and scale.** If you plan to enter an expression or condition, verify that the datatype matches the return value of the expression.
- **Port type.** Transformations can contain a combination of input, output, input/output, and variable port types.
- **Default value.** Assign a default value for a port that contains null values or an output transformation error. You can override the default value in some ports.
- **Description.** A description of the port.
- **Other properties.** Some transformations have properties specific to that transformation, such as expressions or group by properties.

Linking Ports

After you add and configure a transformation in a mapping, you link it to targets and other transformations. You link mapping objects through the ports. Data passes into and out of a mapping through the following ports:

- **Input ports.** Receive data.
- **Output ports.** Pass data.
- **Input/output ports.** Receive data and pass it unchanged.

To link ports, drag between ports in different mapping objects. The Designer validates the link and creates the link only when the link meets validation requirements.

Multi-Group Transformations

A transformation can have multiple input and output groups. A group is a set of ports that define a row of incoming or outgoing data.

A group is analogous to a table in a relational source or target definition. Most transformations have one input and one output group. However, some have multiple input groups, multiple output groups, or both. A group is the representation of a row of data entering or leaving a transformation.

All multi-group transformations are active transformations. You cannot connect multiple active transformations or an active and a passive transformation to the same downstream transformation or transformation input group.

Some multiple input group transformations require the Integration Service to block data at an input group while the Integration Service waits for a row from a different input group. A blocking transformation is a multiple input group transformation that blocks incoming data. The following transformations are blocking transformations:

- Custom transformation with the Inputs May Block property enabled
- Joiner transformation configured for unsorted input

When you save or validate a mapping, some mappings that contain active or blocking transformations might not be valid.

Working with Expressions

You can enter expressions using the Expression Editor in some transformations. Create expressions with the following functions:

- **Transformation language functions.** SQL-like functions designed to handle common expressions.
- **User-defined functions.** Functions you create in PowerCenter based on transformation language functions.
- **Custom functions.** Functions you create with the Custom Function API.

Enter an expression in a port that uses the value of data from an input or input/output port. For example, you have a transformation with an input port IN_SALARY that contains the salaries of all the employees. You might use the values from the IN_SALARY column later in the mapping, and the total and average salaries you calculate through this transformation. For this reason, the Designer requires you to create a separate output port for each calculated value.

The following table lists the transformations in which you can enter expressions:

Transformation	Expression	Return Value
Aggregator	Performs an aggregate calculation based on all data passed through the transformation. Alternatively, you can specify a filter for records in the aggregate calculation to exclude certain kinds of records. For example, you can find the total number and average salary of all employees in a branch office using this transformation.	Result of an aggregate calculation for a port.
Data Masking	Performs a calculation based on the value of input or output ports for a row. An expression is a method to mask production data in the Data Masking transformation.	Result of a row-level calculation using input or output ports.
Expression	Performs a calculation based on values within a single row. For example, based on the price and quantity of a particular item, you can calculate the total purchase price for that line item in an order.	Result of a row-level calculation for a port.

Transformation	Expression	Return Value
Filter	Specifies a condition used to filter rows passed through this transformation. For example, if you want to write customer data to the BAD_DEBT table for customers with outstanding balances, you could use the Filter transformation to filter customer data.	TRUE or FALSE, depending on whether a row meets the specified condition. Only rows that return TRUE are passed through this transformation. The transformation applies this value to each row passed through it.
Rank	Sets the conditions for rows included in a rank. For example, you can rank the top 10 salespeople who are employed with the company.	Result of a condition or calculation for a port.
Router	Routes data into multiple transformations based on a group expression. For example, use this transformation to compare the salaries of employees at three different pay levels. You can do this by creating three groups in the Router transformation. For example, create one group expression for each salary range.	TRUE or FALSE, depending on whether a row meets the specified group expression. Only rows that return TRUE pass through each user-defined group in this transformation. Rows that return FALSE pass through the default group.
Update Strategy	Flags a row for update, insert, delete, or reject. You use this transformation when you want to control updates to a target, based on some condition you apply. For example, you might use the Update Strategy transformation to flag all customer rows for update when the mailing address has changed, or flag all employee rows for reject for people who no longer work for the company.	Numeric code for update, insert, delete, or reject. The transformation applies this value to each row passed through it.
Transaction Control	Specifies a condition used to determine the action the Integration Service performs, either commit, roll back, or no transaction change. You use this transformation when you want to control commit and rollback transactions based on a row or set of rows that pass through the transformation. For example, use this transformation to commit a set of rows based on an order entry date.	One of the following built-in variables, depending on whether or not a row meets the specified condition: <ul style="list-style-type: none"> - TC_CONTINUE_TRANSACTION - TC_COMMIT_BEFORE - TC_COMMIT_AFTER - TC_ROLLBACK_BEFORE - TC_ROLLBACK_AFTER The Integration Service performs actions based on the return value.

Using the Expression Editor

Use the Expression Editor to build SQL-like statements. Although you can enter an expression manually, use the point-and-click method. Select functions, ports, variables, and operators from the point-and-click interface to minimize errors when you build expressions. The maximum number of characters that you can include in an expression is 32,767.

You can evaluate expressions that you configure in the Expression Editor of an Expression transformation.

When you test an expression, you can enter sample data and then evaluate the expression. Evaluate expressions in reusable transformations in the Transformation Designer. Evaluate expressions in non-reusable transformations in the Mapping Designer. Some functions do not support evaluating an expression when you set the port data type to either Binary or Date/Time.

Entering Port Names into an Expression

For connected transformations, if you use port names in an expression, the Designer updates that expression when you change port names in the transformation. For example, you write a valid expression that determines the difference between two dates, `Date_Promised` and `Date_Delivered`. Later, if you change the `Date_Promised` port name to `Due_Date`, the Designer changes the `Date_Promised` port name to `Due_Date` in the expression.

Note: You can propagate the name `Due_Date` to other non-reusable transformations that depend on this port in the mapping.

Adding Comments

You can add comments to an expression to give descriptive information about the expression or to specify a valid URL to access business documentation about the expression.

You can add comments in one of the following ways:

- To add comments within the expression, use `--` or `//` comment indicators.
- To add comments in the dialog box, click the Comments button.

Validating Expressions

Use the Validate button to validate an expression. If you do not validate an expression, the Designer validates it when you close the Expression Editor. If the expression is invalid, the Designer displays a warning. You can save the invalid expression or modify it. You cannot run a session against a mapping with invalid expressions.

Expression Editor Display

The Expression Editor can display syntax expressions in different colors for better readability. If you have the latest Rich Edit control, `riched20.dll`, installed on the system, the Expression Editor displays expression functions in blue, comments in grey, and quoted strings in green.

You can resize the Expression Editor. Expand the dialog box by dragging from the borders. The Designer saves the new size for the dialog box as a client setting.

Adding Expressions to a Port

In the Data Masking transformation, you can add an expression to an input port. For all other transformations, add the expression to an output port.

Complete the following steps to add an expression to a port:

1. In the transformation, select the port and open the Expression Editor.
2. Enter the expression.
Use the Functions and Ports tabs and the operator keys.
3. Add comments to the expression.
Use comment indicators `--` or `//`.
4. Validate the expression.
Use the Validate button to validate the expression.

Defining Expression Strings in Parameter Files

The Integration Service expands the mapping parameters and variables in an expression after it parses the expression. If you have an expression that changes frequently, you can define the expression string in a parameter file so that you do not have to update the mappings that use the expression when the expression changes.

To define an expression string in a parameter file, you create a mapping parameter or variable to store the expression string, and set the parameter or variable to the expression string in the parameter file. The parameter or variable you create must have `IsExprVar` set to true. When `IsExprVar` is true, the Integration Service expands the parameter or variable before it parses the expression.

For example, to define the expression `IIF(color='red',5)` in a parameter file, perform the following steps:

1. In the mapping that uses the expression, create a mapping parameter `$$Exp`. Set `IsExprVar` to true and set the datatype to String.
2. In the Expression Editor, set the expression to the name of the mapping parameter as follows:
`$$Exp`
3. Configure the session or workflow to use a parameter file.
4. In the parameter file, set the value of `$$Exp` to the expression string as follows:

```
$$Exp=IIF(color='red',5)
```

Evaluate Expressions

You can evaluate expressions that you configure in the Expression Editor of an Expression transformation. When you test an expression, you can enter sample data and then evaluate the expression.

If you edit an expression condition, you must select **Refresh** in the test panel before you can evaluate test data. If you do not enter a valid expression, the test panel fails to populate ports. When you specify system-defined parameters, the value that you enter is not a run-time value.

The following image displays how to evaluate a sample expression within an Expression Editor of an Expression transformation:

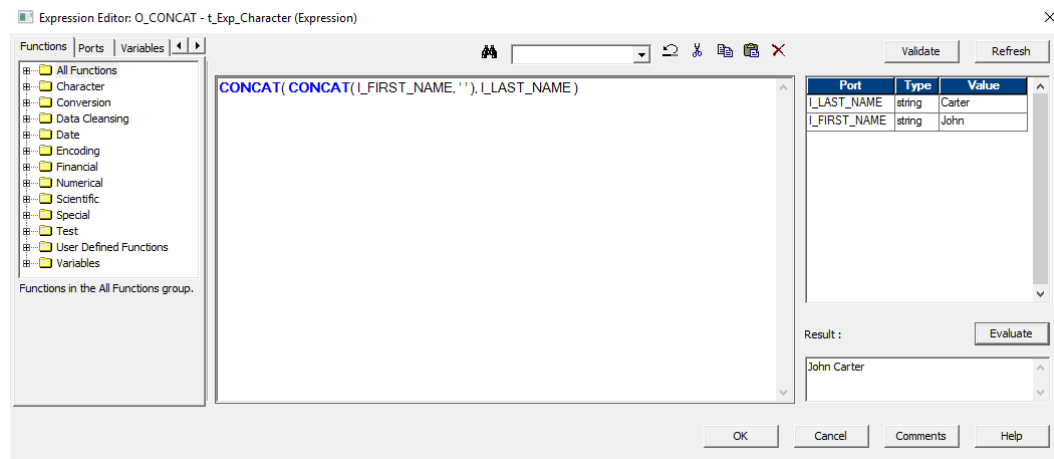

Note: You cannot evaluate expressions of the Date/Time or Binary data types.

Example

You need to calculate promotional offers based on the total number of orders received for each customer before loading all the results to the target. You develop a mapping to calculate offers by defining an

expression within the Expression transformation. You evaluate the expression to verify the result before the operator runs the mapping.

Evaluating an Expression

You can test and verify expressions in the Expression Editor of an Expression transformation.

1. In the Expression Editor of an Expression transformation, enter an expression.
2. To validate the expression, click Validate.
3. To reflect the latest changes from the expression condition in the test expression section in the right pane, click Refresh.
4. In the right pane, enter sample values for the input ports used within the expression.
5. To evaluate the expression, click Evaluate.

Evaluate Expression Restrictions

Certain restrictions apply when you evaluate an expression.

Consider the following restrictions when you evaluate expressions:

Transformation restrictions

You cannot evaluate expressions in the following transformations:

- Aggregator
- Data Masking
- Filter
- Rank
- Router
- Stored Procedure
- Transaction Control
- Update Strategy

Data type restrictions

You cannot evaluate an expression if the input port type or the return function contains a Binary or a Date/Time data type.

Port restrictions

You cannot evaluate an expression that uses the Lookup or Stored Procedure port.

Local Variables

Use local variables in Aggregator, Expression, and Rank transformations to improve performance. You can reference variables in an expression or use them to temporarily store data.

You might use variables to complete the following tasks:

- Temporarily store data.
- Simplify complex expressions.

- Store values from prior rows.
- Capture multiple return values from a stored procedure.
- Compare values.
- Store the results of an unconnected Lookup transformation.

Temporarily Store Data and Simplify Complex Expressions

Variables increase performance when you enter multiple related expressions in the same transformation. You can define components as variables instead of parsing and validating the same expression components multiple times in the transformation.

For example, if an Aggregator transformation uses the same filter condition before calculating sums and averages, you can define this condition as a variable, and then reuse the condition in both aggregate calculations.

You can simplify complex expressions. If an Aggregator includes the same calculation in multiple expressions, you can increase performance by creating a variable to store the results of the calculation.

For example, you might create the following expressions to find both the average salary and the total salary with the same data:

```
AVG( SALARY, ( ( JOB_STATUS = 'Full-time' ) AND (OFFICE_ID = 1000 ) ) )
SUM( SALARY, ( ( JOB_STATUS = 'Full-time' ) AND (OFFICE_ID = 1000 ) ) )
```

Instead of entering the same arguments for both calculations, you might create a variable port for each condition in this calculation, and then change the expression to use the variables.

The following table shows how to use variables to simplify complex expressions and temporarily store data:

Port	Value
V_CONDITION1	JOB_STATUS = 'Full-time'
V_CONDITION2	OFFICE_ID = 1000
AVG_SALARY	AVG(SALARY, (V_CONDITION1 AND V_CONDITION2))
SUM_SALARY	SUM(SALARY, (V_CONDITION1 AND V_CONDITION2))

Store Values Across Rows

You can configure variables in transformations to store data from source rows. You can use the variables in transformation expressions.

For example, a source file contains the following rows:

```
California
California
California
Hawaii
Hawaii
New Mexico
New Mexico
New Mexico
```

Each row contains a state. You need to count the number of rows and return the row count for each state:

```
California,3
Hawaii    ,2
New Mexico,3
```

You can configure an Aggregator transformation to group the source rows by state and count the number of rows in each group. Configure a variable in the Aggregator transformation to store the row count. Define another variable to store the state name from the previous row.

The Aggregator transformation has the following ports:

Port	Port Type	Expression	Description
State	Pass-through	n/a	The name of a state. The source rows are grouped by the state name. The Aggregator transformation returns one row for each state.
State_Count	Variable	IIF (PREVIOUS_STATE = STATE, STATE_COUNT +1, 1)	The row count for the current State. When the value of the current State column is the same as the Previous_State column, the Integration Service increments State_Count. Otherwise, it resets the State_Count to 1.
Previous_State	Variable	State	The value of the State column in the previous row. When the Integration Service processes a row, it moves the State value to Previous_State.
State_Counter	Output	State_Count	The number of rows the Aggregator transformation processed for a state. The Integration Service returns State_Counter once for each state.

Capture Values from Stored Procedures

Variables provide a way to capture multiple columns of return values from stored procedures.

Guidelines for Configuring Variable Ports

Consider the following factors when you configure variable ports in a transformation:

- **Port order.** The Integration Service evaluates ports by dependency. The order of the ports in a transformation must match the order of evaluation: input ports, variable ports, output ports.
- **Datatype.** The datatype you choose reflects the return value of the expression you enter.
- **Variable initialization.** The Integration Service sets initial values in variable ports, where you can create counters.

Port Order

The Integration Service evaluates the input ports first. The Integration Service evaluates the variable ports next, and the output ports last.

The Integration Service evaluates ports in the following order:

1. **Input ports.** The Integration Service evaluates all input ports first since they do not depend on any other ports. Therefore, you can create input ports in any order. The Integration Service does not order input ports because input ports do not reference other ports.

2. **Variable ports.** Variable ports can reference input ports and variable ports, but not output ports. Because variable ports can reference input ports, the Integration Service evaluates variable ports after input ports. Variables can reference other variables, so the display order for variable ports is the same as the order in which the Integration Service evaluates each variable.

For example, if you calculate the original value of a building and then adjust for depreciation, you might create the original value calculation as a variable port. This variable port needs to appear before the port that adjusts for depreciation.

3. **Output ports.** The Integration Service evaluates output ports last, because output ports can reference input ports and variable ports. The display order for output ports does not matter because output ports cannot reference other output ports. Be sure output ports display at the bottom of the list of ports.

Data Type

When you configure a port as a variable, you can enter any expression or condition in it. The data type you choose for this port reflects the return value of the expression you enter. If you specify a condition through the variable port, any numeric data type returns the values for TRUE (non-zero) and FALSE (zero).

Variable Initialization

The Integration Service does not set the initial value for variables to NULL.

The Integration Service uses the following guidelines to set initial values for variables:

- Zero for numeric ports
- Empty strings for string ports
- 01/01/0001 for Date/Time ports

Therefore, use variables as counters, which need an initial value. For example, you can create a numeric variable with the following expression:

```
VAR1 + 1
```

This expression counts the number of rows in the VAR1 port. If the initial value of the variable were set to NULL, the expression would always evaluate to NULL. This is why the initial value is set to zero.

Default Values for Ports

All transformations use default values that determine how the Integration Service handles input null values and output transformation errors.

Input, output, and input/output ports have a system default value that you can sometimes override with a user-defined default value. Default values have different functions in different types of ports:

- **Input port.** The system default value for null input ports is NULL. The default value appears as a blank in the transformation. If an input value is NULL, the Integration Service leaves it as NULL.
- **Output port.** The system default value for output transformation errors is ERROR. The default value appears in the transformation as ERROR('transformation error'). If a transformation error occurs, the Integration Service skips the row. The Integration Service notes all input rows that the ERROR function skips in the log file.

The following errors are transformation errors:

- Data conversion errors, such as passing a number to a date function.
- Expression evaluation errors, such as dividing by zero.
- Calls to an ERROR function.
- **Pass-through port.** The system default value for null input is the same as input ports, NULL. The system default value appears as a blank in the transformation. The default value for output transformation errors is the same as output ports. The default value for output transformation errors does not display in the transformation.

Note: The Java Transformation converts PowerCenter® datatypes to Java datatypes, based on the Java Transformation port type. Default values for null input differ based on the Java datatype.

The following table shows the system default values for ports in connected transformations:

Port Type	Default Value	Integration Service Behavior	User-Defined Default Value Supported
Input, Pass-through	NULL	Integration Service passes all input null values as NULL.	Input, Input/Output
Output, Pass-through	ERROR	Integration Service calls the ERROR function for output port transformation errors. The Integration Service skips rows with errors and writes the input data and the error message in the log file.	Output

Variable ports do not support default values. The Integration Service initializes variable ports according to the datatype.

You can override some of the default values to change the Integration Service behavior when it encounters null input values and output transformation errors.

User-Defined Default Values

You can override the system default values with user-defined default values for supported input, pass-through, and output ports within a connected transformation.

Use the following rules and guidelines to override the system default values for ports:

- **Input ports.** You can enter user-defined default values for input ports if you do not want the Integration Service to treat null values as NULL. If NULL is passed to the input port, the Integration Service replaces NULL with the default value.
- **Output ports.** You can enter user-defined default values for output ports if you do not want the Integration Service to skip the row or if you want the Integration Service to write a specific message with the skipped row to the log. If you define a default value in the output port, the Integration Service replaces the row with the default value when the output port has a transformation error.
- **Pass-through ports.** You can enter user-defined default values for pass-through ports if you do not want the Integration Service to treat null values as NULL. You cannot enter user-defined default values for output transformation errors in a pass-through port.

Note: The Integration Service ignores user-defined default values for unconnected transformations. For example, if you call a Lookup or Stored Procedure transformation through an expression, the Integration Service ignores any user-defined default value and it applies the system default value.

Use the following options to enter user-defined default values:

- **Constant value.** Use any constant (numeric or text), including NULL.
- **Constant expression.** You can include a transformation function with constant parameters.
- **ERROR.** Generate a transformation error. Write the row and a message in the session log or row error log.
- **ABORT.** Abort the session.

Constant Values

You can enter any constant value as a default value. The constant value must match the port datatype.

For example, a default value for a numeric port must be a numeric constant. Some constant values include:

```
0
9999
NULL
'Unknown Value'
'Null input data'
```

Constant Expressions

A constant expression is any expression that uses transformation functions (except aggregate functions) to write constant expressions. You cannot use values from input, input/output, or variable ports in a constant expression.

Some valid constant expressions include:

```
500 * 1.75
TO_DATE('January 1, 1998, 12:05 AM','MONTH DD, YYYY, HH:MI AM')
ERROR ('Null not allowed')
ABORT('Null not allowed')
SESSSTARTTIME
```

You cannot use values from ports within the expression because the Integration Service assigns default values for the entire mapping when it initializes the session.

The following examples are not valid because they use values from ports:

```
AVG(IN_SALARY)
IN_PRICE * IN_QUANTITY
:LKP(LKP_DATES, DATE_SHIPPED)
```

Note: You cannot call a stored procedure or lookup table from a default value expression.

ERROR and ABORT Functions

Use the ERROR and ABORT functions for input and output port default values, and input values for input/output ports. The Integration Service skips the row when it encounters the ERROR function. It aborts the session when it encounters the ABORT function.

User-Defined Default Input Values

You can enter a user-defined default input value if you do not want the Integration Service to treat null values as NULL.

To override null values, complete one of the following tasks:

- Replace the null value with a constant value or constant expression.
- Skip the null value with an ERROR function.
- Abort the session with the ABORT function.

The following table summarizes how the Integration Service handles null input for input and input/output ports:

Default Value	Default Value Type	Description
NULL (displays blank)	System	Integration Service passes NULL.
Constant or Constant expression	User-Defined	Integration Service replaces the null value with the value of the constant or constant expression.
ERROR	User-Defined	Integration Service treats this as a transformation error: <ul style="list-style-type: none"> - Increases the transformation error count by 1. - Skips the row, and writes the error message to the log file or row error log. The Integration Service does not write rows to the reject file.
ABORT	User-Defined	Session aborts when the Integration Service encounters a null input value. The Integration Service does not increase the error count or write rows to the reject file.

Replace Null Values

Use a constant value or expression to substitute a specified value for null values in a port.

For example, if an input string port is called DEPT_NAME and you want to replace null values with the string 'UNKNOWN DEPT', you could set the default value to 'UNKNOWN DEPT'. Depending on the transformation, the Integration Service passes 'UNKNOWN DEPT' to an expression or variable within the transformation or to the next transformation in the data flow.

For example, the Integration Service replaces all null values in a port with the string 'UNKNOWN DEPT.'

DEPT_NAME	REPLACED VALUE
Housewares	Housewares
NULL	UNKNOWN DEPT
Produce	Produce

Skip Null Records

Use the ERROR function as the default value when you do not want null values to pass into a transformation. For example, you might want to skip a row when the input value of DEPT_NAME is NULL. You could use the following expression as the default value:

```
ERROR('Error. DEPT is NULL')
```

When you use the ERROR function as a default value, the Integration Service skips the row with the null value. The Integration Service writes all rows skipped by the ERROR function into the log file. It does not write these rows to the reject file.

DEPT_NAME	RETURN VALUE
Housewares	Housewares
NULL	'Error. DEPT is NULL' (Row is skipped)
Produce	Produce

The following log shows where the Integration Service skips the row with the null value:

```
TE 11019 Port [DEPT_NAME]: Default value is: ERROR(<<Transformation Error>> [error]:
Error. DEPT is NULL
... error('Error. DEPT is NULL')
).
```

```

CMN_1053 EXPTRANS: : ERROR: NULL input column DEPT_NAME: Current Input data:
CMN_1053   Input row from SRCTRANS: Rowdata: ( RowType=4 Src Rowid=2 Targ Rowid=2
  DEPT_ID (DEPT_ID:Int:): "2"
  DEPT_NAME (DEPT_NAME:Char.25:): "NULL"
  MANAGER_ID (MANAGER_ID:Int:): "1"
)

```

Abort the Session

Use the ABORT function to abort a session when the Integration Service encounters null input values.

User-Defined Default Output Values

You can create user-defined default values to override the system default values for output ports.

You can enter user-defined default values for output ports if you do not want the Integration Service to skip rows with errors or if you want the Integration Service to write a specific message with the skipped row to the log. You can enter default values to complete the following functions when the Integration Service encounters output transformation errors:

- Replace the error with a constant value or constant expression. The Integration Service does not skip the row.
- Abort the session with the ABORT function.
- Write specific messages in the log for transformation errors.

You cannot enter user-defined default output values for input/output ports.

The following table summarizes how the Integration Service handles output port transformation errors and default values in transformations:

Default Value	Default Value Type	Description
Transformation Error	System	When a transformation error occurs and you did not override the default value, the Integration Service performs the following tasks: <ul style="list-style-type: none"> - Increases the transformation error count by 1. - Skips the row, and writes the error and input row to the session log file or row error log, depending on session configuration. The Integration Service does not write the row to the reject file.
Constant or Constant Expression	User-Defined	Integration Service replaces the error with the default value. The Integration Service does not increase the error count or write a message to the log.
ABORT	User-Defined	Session aborts and the Integration Service writes a message to the session log. The Integration Service does not increase the error count or write rows to the reject file.

Replace Errors

If you do not want the Integration Service to skip a row when a transformation error occurs, use a constant or constant expression as the default value for an output port.

For example, if you have a numeric output port called NET_SALARY and you want to use the constant value '9999' when a transformation error occurs, assign the default value 9999 to the NET_SALARY port. If there is

any transformation error (such as dividing by zero) while computing the value of NET_SALARY, the Integration Service uses the default value 9999.

Aborting the Session

Use the ABORT function as the default value in an output port if you do not want to allow transformation errors.

Write Messages in the Session Log or Row Error Logs

You can enter a user-defined default value in the output port if you want the Integration Service to write a specific message in the session log with the skipped row. The system default is ERROR ('transformation error'), and the Integration Service writes the message 'transformation error' in the session log along with the skipped row. You can replace 'transformation error' if you want to write a different message.

When you enable row error logging, the Integration Service writes error messages to the error log instead of the session log and the Integration Service does not log Transaction Control transformation rollback or commit errors. If you want to write rows to the session log in addition to the row error log, you can enable verbose data tracing.

ERROR Functions in Output Port Expressions

If you enter an expression that uses the ERROR function, the user-defined default value for the output port might override the ERROR function in the expression.

For example, you enter the following expression that instructs the Integration Service to use the value 'Negative Sale' when it encounters an error:

```
IIF( TOTAL_SALES>0, TOTAL_SALES, ERROR ('Negative Sale'))
```

The following examples show how user-defined default values may override the ERROR function in the expression:

- **Constant value or expression.** The constant value or expression overrides the ERROR function in the output port expression.

For example, if you enter '0' as the default value, the Integration Service overrides the ERROR function in the output port expression. It passes the value 0 when it encounters an error. It does not skip the row or write 'Negative Sale' in the log.

- **ABORT.** The ABORT function overrides the ERROR function in the output port expression.

If you use the ABORT function as the default value, the Integration Service aborts the when a transformation error occurs. The ABORT function overrides the ERROR function in the output port expression.

- **ERROR.** If you use the ERROR function as the default value, the Integration Service includes the following information in the log:

- Error message from the default value
- Error message indicated in the ERROR function in the output port expression
- Skipped row

For example, you can override the default value with the following ERROR function:

```
ERROR('No default value')
```

The Integration Service skips the row, and includes both error messages in the log.

```
TE_7007 Transformation Evaluation Error; current row skipped...
TE_7007 [<<Transformation Error>> [error]: Negative Sale
... error('Negative Sale')
```

```
]
Sun Sep 20 13:57:28 1998
TE_11019 Port [OUT_SALES]: Default value is: ERROR(<<Transformation Error>> [error]:
No default value
... error('No default value')
```

General Rules for Default Values

Use the following rules and guidelines when you create default values:

- The default value must be either a NULL, a constant value, a constant expression, an ERROR function, or an ABORT function.
- For input/output ports, the Integration Service uses default values to handle null input values. The output default value of input/output ports is always ERROR('Transformation Error').
- Variable ports do not use default values.
- You can assign default values to group by ports in the Aggregator and Rank transformations.
- Not all port types in all transformations allow user-defined default values. If a port does not allow user-defined default values, the default value field is disabled.
- Not all transformations allow user-defined default values.
- If a transformation is not connected to the mapping data flow, the Integration Service ignores user-defined default values.
- If any input port is unconnected, its value is assumed to be NULL and the Integration Service uses the default value for that input port.
- If an input port default value contains the ABORT function and the input value is NULL, the Integration Service immediately stops the session. Use the ABORT function as a default value to restrict null input values. The first null value in an input port stops the session.
- If an output port default value contains the ABORT function and any transformation error occurs for that port, the session immediately stops. Use the ABORT function as a default value to enforce strict rules for transformation errors. The first transformation error for this port stops the session.
- The ABORT function, constant values, and constant expressions override ERROR functions configured in output port expressions.

Default Value Validation

You can validate default values as you enter them. The Designer includes a Validate button so you can ensure valid default values. A message appears indicating if the default is valid.

The Designer also validates default values when you save a mapping. If you enter an invalid default value, the Designer marks the mapping as not valid.

Configuring Tracing Level in Transformations

When you configure a transformation, you can set the amount of detail the Integration Service writes in the session log.

The following table describes the session log tracing levels:

Tracing Level	Description
Normal	Integration Service logs initialization and status information, errors encountered, and skipped rows due to transformation row errors. Summarizes session results, but not at the level of individual rows.
Terse	Integration Service logs initialization information and error messages and notification of rejected data.
Verbose Initialization	In addition to normal tracing, Integration Service logs additional initialization details, names of index and data files used, and detailed transformation statistics.
Verbose Data	<p>In addition to verbose initialization tracing, Integration Service logs each row that passes into the mapping. Also notes where the Integration Service truncates string data to fit the precision of a column and provides detailed transformation statistics.</p> <p>Allows the Integration Service to write errors to both the session log and error log when you enable row error logging.</p> <p>When you configure the tracing level to verbose data, the Integration Service writes row data for all rows in a block when it processes a transformation.</p>

By default, the tracing level for every transformation is Normal. Change the tracing level to a Verbose setting only when you need to debug a transformation that is not behaving as expected. To add a slight performance boost, you can also set the tracing level to Terse, writing the minimum of detail to the session log when running a workflow containing the transformation.

When you configure a session, you can override the tracing levels for individual transformations with a single tracing level for all transformations in the session.

Reusable Transformations

Mappings can contain reusable and non-reusable transformations. Non-reusable transformations exist within a single mapping. Reusable transformations can be used in multiple mappings.

For example, you might create an Expression transformation that calculates value-added tax for sales in Canada, which is useful when you analyze the cost of doing business in that country. Rather than perform the same work every time, you can create a reusable transformation. When you need to incorporate this transformation into a mapping, you add an instance of it to the mapping. Later, if you change the definition of the transformation, all instances of it inherit the changes.

The Designer stores each reusable transformation as metadata separate from any mapping that uses the transformation. If you review the contents of a folder in the Navigator, you see the list of all reusable transformations in that folder.

Each reusable transformation falls within a category of transformations available in the Designer. For example, you can create a reusable Aggregator transformation to perform the same aggregate calculations in multiple mappings, or a reusable Stored Procedure transformation to call the same stored procedure in multiple mappings.

You can create most transformations as a non-reusable or reusable. However, you can only create the External Procedure transformation as a reusable transformation.

When you add instances of a reusable transformation to mappings, you must be careful that changes you make to the transformation do not invalidate the mapping or generate unexpected data.

Instances and Inherited Changes

When you add a reusable transformation to a mapping, you add an instance of the transformation. The definition of the transformation still exists outside the mapping, while an instance of the transformation appears within the mapping.

Since the instance of a reusable transformation is a pointer to that transformation, when you change the transformation in the Transformation Developer, its instances reflect these changes. Instead of updating the same transformation in every mapping that uses it, you can update the reusable transformation once, and all instances of the transformation inherit the change. Note that instances do not inherit changes to property settings, only modifications to ports, expressions, and the name of the transformation.

Mapping Variables in Expressions

Use mapping parameters and variables in reusable transformation expressions. When the Designer validates the parameter or variable, it treats it as an Integer datatype. When you use the transformation in a mapplet or mapping, the Designer validates the expression again. If the mapping parameter or variable does not exist in the mapplet or mapping, the Designer logs an error.

Creating Reusable Transformations

You can create a reusable transformation using the following methods:

- **Design it in the Transformation Developer.** In the Transformation Developer, you can build new reusable transformations.
- **Promote a non-reusable transformation from the Mapping Designer.** After you add a transformation to a mapping, you can promote it to the status of reusable transformation. The transformation designed in the mapping then becomes an instance of a reusable transformation maintained elsewhere in the repository.

If you promote a transformation to reusable status, you cannot demote it. However, you can create a non-reusable instance of it.

Note: Sequence Generator transformations must be reusable in mapplets. You cannot demote reusable Sequence Generator transformations to non-reusable in a mapplet.

To create a reusable transformation:

1. In the Designer, switch to the Transformation Developer.
2. Click the button on the Transformation toolbar corresponding to the type of transformation you want to create.
3. Drag within the workbook to create the transformation.
4. Double-click the transformation title bar to open the dialog displaying its properties.
5. Click the Rename button and enter a descriptive name for the transformation, and click OK.
6. Click the Ports tab, then add any input and output ports you need for this transformation.
7. Set the other properties of the transformation, and click OK.

These properties vary according to the transformation you create. For example, if you create an Expression transformation, you need to enter an expression for one or more of the transformation output ports. If you create a Stored Procedure transformation, you need to identify the stored procedure to call.

Promoting Non-Reusable Transformations

The other technique for creating a reusable transformation is to promote an existing transformation within a mapping. By checking the Make Reusable option in the Edit Transformations dialog box, you instruct the Designer to promote the transformation and create an instance of it in the mapping.

To promote a non-reusable transformation:

1. In the Designer, open a mapping and double-click the title bar of the transformation you want to promote.
2. Select the Make Reusable option.
3. When prompted whether you are sure you want to promote the transformation, click Yes.
4. Click OK to return to the mapping.

Now, when you look at the list of reusable transformations in the folder you are working in, the newly promoted transformation appears in this list.

Creating Non-Reusable Instances of Reusable Transformations

You can create a non-reusable instance of a reusable transformation within a mapping. Reusable transformations must be made non-reusable within the same folder. If you want to have a non-reusable instance of a reusable transformation in a different folder, you need to first make a non-reusable instance of the transformation in the source folder, and then copy it into the target folder.

To create a non-reusable instance of a reusable transformation:

1. In the Designer, open a mapping.
2. In the Navigator, select an existing transformation and drag the transformation into the mapping workspace. Hold down the Ctrl key before you release the transformation.

The status bar displays the following message:

```
Make a non-reusable copy of this transformation and add it to this mapping.
```

3. Release the transformation.

The Designer creates a non-reusable instance of the existing reusable transformation.

Adding Reusable Transformations to Mappings

After you create a reusable transformation, you can add it to mappings.

To add a reusable transformation:

1. In the Designer, switch to the Mapping Designer.
2. Open or create a mapping.
3. In the list of repository objects, drill down until you find the reusable transformation you want in the Transformations section of a folder.
4. Drag the transformation from the Navigator into the mapping.
A copy (or instance) of the reusable transformation appears.
5. Link the new transformation to other transformations or target definitions.

Modifying a Reusable Transformation

Changes to a reusable transformation that you enter through the Transformation Developer are immediately reflected in all instances of that transformation. While this feature is a powerful way to save work and enforce standards, you risk invalidating mappings when you modify a reusable transformation.

To see what mappings, mapplets, or shortcuts may be affected by changes you make to a transformation, select the transformation in the workspace or Navigator, right-click, and select View Dependencies.

If you make any of the following changes to the reusable transformation, mappings that use instances of it may be invalidated:

- When you delete a port or multiple ports in a transformation, you disconnect the instance from part or all of the data flow through the mapping.
- When you change a port datatype, you make it impossible to map data from that port to another port using an incompatible datatype.
- When you change a port name, expressions that refer to the port are no longer valid.
- When you enter an invalid expression in the reusable transformation, mappings that use the transformation are no longer valid. The Integration Service cannot run sessions based on invalid mappings.

Reverting to Original Reusable Transformation

If you change the properties of a reusable transformation in a mapping, you can revert to the original reusable transformation properties by clicking the Revert button.

CHAPTER 2

Aggregator Transformation

This chapter includes the following topics:

- [Aggregator Transformation Overview, 49](#)
- [Components of the Aggregator Transformation, 50](#)
- [Configuring Aggregate Caches, 51](#)
- [Aggregate Expressions, 52](#)
- [Group By Ports, 53](#)
- [Using Sorted Input, 55](#)
- [Creating an Aggregator Transformation, 57](#)
- [Tips for Aggregator Transformations, 57](#)
- [Troubleshooting Aggregator Transformations, 58](#)

Aggregator Transformation Overview

The Aggregator transformation performs aggregate calculations, such as averages and sums. The Integration Service performs aggregate calculations as it reads and stores data group and row data in an aggregate cache. The Aggregator transformation is an active transformation.

The Aggregator transformation is unlike the Expression transformation, in that you use the Aggregator transformation to perform calculations on groups. The Expression transformation permits you to perform calculations on a row-by-row basis.

When you use the transformation language to create aggregate expressions, you can use conditional clauses to filter rows, providing more flexibility than SQL language.

After you create a session that includes an Aggregator transformation, you can enable the session option, Incremental Aggregation. When the Integration Service performs incremental aggregation, it passes source data through the mapping and uses historical cache data to perform aggregation calculations incrementally.

Components of the Aggregator Transformation

The Aggregator is an active transformation that changes the number of rows in the pipeline. The Aggregator transformation has the following components and options:

- **Aggregate cache.** The Integration Service stores data in the aggregate cache until it completes aggregate calculations. The Integration Service stores group values in an index cache and it stores row data in the data cache.
- **Aggregate expression.** Enter an expression in an output port. The expression can include nonaggregate expressions and conditional clauses.
- **Group by port.** Indicate how to create groups. You can configure an input, input/output, output, or variable port for the group. When grouping data, the Aggregator transformation outputs the last row of each group unless otherwise specified.
- **Sorted input.** Select this option to improve session performance. To use sorted input, you must pass data to the Aggregator transformation sorted by group by port, in ascending or descending order.

You can configure the Aggregator transformation components and options on the Properties and Ports tab.

Configuring Aggregator Transformation Properties

Modify the Aggregator Transformation properties on the Properties tab.

Configure the following options:

Aggregator Setting	Description
Cache Directory	Local directory where the Integration Service creates the index and data cache files. By default, the Integration Service uses the directory entered in the Workflow Manager for the process variable \$PMCCacheDir. If you enter a new directory, make sure the directory exists and contains enough disk space for the aggregate caches. If you have enabled incremental aggregation, the Integration Service creates a backup of the files each time you run the session. The cache directory must contain enough disk space for two sets of the files.
Tracing Level	Amount of detail displayed in the session log for this transformation.
Sorted Input	Indicates input data is presorted by groups. Select this option only if the mapping passes sorted data to the Aggregator transformation.
Aggregator Data Cache Size	Data cache size for the transformation. Default cache size is 2,000,000 bytes. If the total configured session cache size is 2 GB (2,147,483,648 bytes) or greater, you must run the session on a 64-bit Integration Service. You can use a numeric value for the cache, you can use a cache value from a parameter file or you can configure the Integration Service to set the cache size by using the Auto setting. If you configure the Integration Service to determine the cache size, you can also configure a maximum amount of memory for the Integration Service to allocate to the cache.

Aggregator Setting	Description
Aggregator Index Cache Size	Index cache size for the transformation. Default cache size is 1,000,000 bytes. If the total configured session cache size is 2 GB (2,147,483,648 bytes) or greater, you must run the session on a 64-bit Integration Service. You can use a numeric value for the cache, you can use a cache value from a parameter file or you can configure the Integration Service to set the cache size by using the Auto setting. If you configure the Integration Service to determine the cache size, you can also configure a maximum amount of memory for the Integration Service to allocate to the cache.
Transformation Scope	Specifies how the Integration Service applies the transformation logic to incoming data: <ul style="list-style-type: none"> - Transaction. Applies the transformation logic to all rows in a transaction. Choose Transaction when a row of data depends on all rows in the same transaction, but does not depend on rows in other transactions. - All Input. Applies the transformation logic on all incoming data. When you choose All Input, the PowerCenter drops incoming transaction boundaries. Choose All Input when a row of data depends on all rows in the source.

Configuring Aggregator Transformation Ports

To configure ports in the Aggregator transformation, complete the following tasks:

- Enter an expression in any output port, using conditional clauses or non-aggregate functions in the port.
- Create multiple aggregate output ports.
- Configure any input, input/output, output, or variable port as a group by port.
- Improve performance by connecting only the necessary input/output ports to subsequent transformations, reducing the size of the data cache.
- Use variable ports for local variables.
- Create connections to other transformations as you enter an expression.

Configuring Aggregate Caches

When you run a session that uses an Aggregator transformation, the Integration Service creates the index and the data caches in memory to process the transformation. If the Integration Service requires more space, it stores overflow values in cache files.

You can use a numeric value for the cache, you can use a cache value from a parameter file or you can configure the Integration Service to set the cache size by using the Auto setting.

Note: The Integration Service uses memory to process an Aggregator transformation with sorted ports. The Integration Service does not use cache memory. You do not need to configure cache memory for Aggregator transformations that use sorted ports.

Aggregate Expressions

The Designer allows aggregate expressions only in the Aggregator transformation. An aggregate expression can include conditional clauses and nonaggregate functions. The expression can also include one aggregate function within another aggregate function, such as:

```
MAX( COUNT( ITEM ) )
```

The result of an aggregate expression varies based on the group by ports in the transformation. For example, when the Integration Service calculates the following aggregate expression with no group by ports defined, it finds the total quantity of items sold:

```
SUM( QUANTITY )
```

However, if you use the same expression, and you group by the ITEM port, the Integration Service returns the total quantity of items sold, by item.

You can create an aggregate expression in any output port and use multiple aggregate ports in a transformation.

RELATED TOPICS:

- [“Working with Expressions” on page 31](#)

Aggregate Functions

Use the following aggregate functions within an Aggregator transformation. You can nest one aggregate function within another aggregate function.

The transformation language includes the following aggregate functions:

- AVG
- COUNT
- FIRST
- LAST
- MAX
- MEDIAN
- MIN
- PERCENTILE
- STDDEV
- SUM
- VARIANCE

When you use any of these functions, you must use them in an expression within an Aggregator transformation.

Nested Aggregate Functions

You can include multiple single-level or multiple nested functions in different output ports in an Aggregator transformation. However, you cannot include both single-level and nested functions in an Aggregator transformation. Therefore, if an Aggregator transformation contains a single-level function in any output port, you cannot use a nested function in any other port in that transformation. When you include single-level and nested functions in the same Aggregator transformation, the Designer marks the mapping or maplet invalid. If you need to create both single-level and nested functions, create separate Aggregator transformations.

Conditional clauses

Use conditional clauses in the aggregate expression to reduce the number of rows used in the aggregation. The conditional clause can be any clause that evaluates to TRUE or FALSE.

For example, use the following expression to calculate the total commissions of employees who exceeded their quarterly quota:

```
SUM( COMMISSION, COMMISSION > QUOTA )
```

Non-Aggregate Functions

You can also use non-aggregate functions in the aggregate expression.

The following expression returns the highest number of items sold for each item (grouped by item). If no items were sold, the expression returns 0.

```
IIF( MAX( QUANTITY ) > 0, MAX( QUANTITY ), 0)
```

Null Values in Aggregate Functions

When you configure the Integration Service, you can choose how you want the Integration Service to handle null values in aggregate functions. You can choose to treat null values in aggregate functions as NULL or zero. By default, the Integration Service treats null values as NULL in aggregate functions.

Group By Ports

The Aggregator transformation lets you define groups for aggregations, rather than performing the aggregation across all input data. For example, rather than finding the total company sales, you can find the total sales grouped by region.

To define a group for the aggregate expression, select the appropriate input, input/output, output, and variable ports in the Aggregator transformation. You can select multiple group by ports to create a new group for each unique combination. The Integration Service then performs the defined aggregation for each group.

When you group values, the Integration Service produces one row for each group. If you do not group values, the Integration Service returns one row for all input rows. The Integration Service typically returns the last row of each group (or the last row received) with the result of the aggregation. However, if you specify a particular row to be returned (for example, by using the FIRST function), the Integration Service then returns the specified row.

When selecting multiple group by ports in the Aggregator transformation, the Integration Service uses port order to determine the order by which it groups. Since group order can affect the results, order group by ports to ensure the appropriate grouping. For example, the results of grouping by ITEM_ID then QUANTITY can vary from grouping by QUANTITY then ITEM_ID, because the numeric values for quantity are not necessarily unique.

The following Aggregator transformation groups first by STORE_ID and then by ITEM:

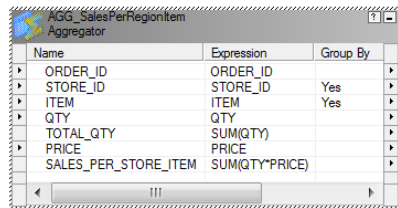

If you send the following data through this Aggregator transformation:

STORE_ID	ITEM	QTY	PRICE
101	'battery'	3	2.99
101	'battery'	1	3.19
101	'battery'	2	2.59
101	'AAA'	2	2.45
201	'battery'	1	1.99
201	'battery'	4	1.59
301	'battery'	1	2.45

The Integration Service performs the aggregate calculation on the following unique groups:

STORE_ID	ITEM
101	'battery'
101	'AAA'
201	'battery'
301	'battery'

The Integration Service then passes the last row received, along with the results of the aggregation, as follows:

STORE_ID	ITEM	TOTAL_QTY	SALES_PER_STORE_ITEM
101	'AAA'	2	4.90
101	'battery'	6	17.34
201	'battery'	5	8.35
301	'battery'	1	2.45

Non-Aggregate Expressions

Use non-aggregate expressions in group by ports to modify or replace groups. For example, if you want to replace 'AAA battery' before grouping, you can create a new group by output port, named CORRECTED_ITEM, using the following expression:

```
IIF( ITEM = 'AAA battery', battery, ITEM )
```

Default Values

Define a default value for each port in the group to replace null input values. This allows the Integration Service to include null item groups in the aggregation.

RELATED TOPICS:

- [“Default Values for Ports” on page 38](#)

Using Sorted Input

You can improve Aggregator transformation performance by using the sorted input option. When you use sorted input, the Integration Service assumes all data is sorted by group and it performs aggregate calculations as it reads rows for a group. When necessary, it stores group information in memory. To use the Sorted Input option, you must pass sorted data to the Aggregator transformation. You can gain performance with sorted ports when you configure the session with multiple partitions.

When you do not use sorted input, the Integration Service performs aggregate calculations as it reads. Since the data is not sorted, the Integration Service stores data for each group until it reads the entire source to ensure all aggregate calculations are accurate.

For example, one Aggregator transformation has the STORE_ID and ITEM group by ports, with the sorted input option selected. When you pass the following data through the Aggregator, the Integration Service performs an aggregation for the three rows in the 101/battery group as soon as it finds the new group, 201/battery:

STORE_ID	ITEM	QTY	PRICE
101	'battery'	3	2.99
101	'battery'	1	3.19
101	'battery'	2	2.59
201	'battery'	4	1.59
201	'battery'	1	1.99

If you use sorted input and do not presort data correctly, you receive unexpected results.

Sorted Input Conditions

Do not use sorted input if either of the following conditions are true:

- The aggregate expression uses nested aggregate functions.
- The session uses incremental aggregation.

If you use sorted input and do not sort data correctly, the session fails.

Sorting Data

To use sorted input, you pass sorted data through the Aggregator.

Data must be sorted in the following ways:

- By the Aggregator group by ports, in the order they appear in the Aggregator transformation.
- Using the same sort order configured for the session. If data is not in strict ascending or descending order based on the session sort order, the Integration Service fails the session. For example, if you configure a session to use a French sort order, data passing into the Aggregator transformation must be sorted using the French sort order.

For relational and file sources, use the Sorter transformation to sort data in the mapping before passing it to the Aggregator transformation. You can place the Sorter transformation anywhere in the mapping prior to the Aggregator if no transformation changes the order of the sorted data. Group by columns in the Aggregator transformation must be in the same order as they appear in the Sorter transformation.

If the session uses relational sources, you can also use the Number of Sorted Ports option in the Source Qualifier transformation to sort group by columns in the source database. Group by columns must be in the same order in both the Aggregator and Source Qualifier transformations.

The following mapping shows a Sorter transformation configured to sort the source data in ascending order by ITEM_NO:

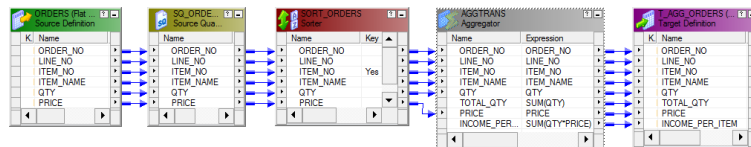

The Sorter transformation sorts the data as follows:

ITEM_NO	ITEM_NAME	QTY	PRICE
345	Soup	4	2.95
345	Soup	1	2.95
345	Soup	2	3.25
546	Cereal	1	4.49
546	Cereal	2	5.25

With sorted input, the Aggregator transformation returns the following results:

ITEM_NO	ITEM_NAME	TOTAL_QTY	INCOME_PER_ITEM
345	Soup	7	21.25
546	Cereal	3	14.99

Creating an Aggregator Transformation

To use an Aggregator transformation in a mapping, add the Aggregator transformation to the mapping. Then configure the transformation with an aggregate expression and group by ports.

To create an Aggregator transformation:

1. In the Mapping Designer, click Transformation > Create. Select the Aggregator transformation.
2. Enter a name for the Aggregator, click Create. Then click Done.
The Designer creates the Aggregator transformation.
3. Drag the ports to the Aggregator transformation.
The Designer creates input/output ports for each port you include.
4. Double-click the title bar of the transformation to open the Edit Transformations dialog box.
5. Select the Ports tab.
6. Click the group by option for each column you want the Aggregator to use in creating groups.
Optionally, enter a default value to replace null groups.
7. Click Add to add an expression port.
The expression port must be an output port. Make the port an output port by clearing Input (I).
8. Optionally, add default values for specific ports.
If the target database does not handle null values and certain ports are likely to contain null values, specify a default value.
9. Configure properties on the Properties tab.

Tips for Aggregator Transformations

Use sorted input to decrease the use of aggregate caches.

Sorted input reduces the amount of data cached during the session and improves session performance. Use this option with the Sorter transformation to pass sorted data to the Aggregator transformation.

The Aggregator transformation might not provide sorted output.

To sort output from an Aggregator transformation, use a Sorter transformation.

Limit connected input/output or output ports.

Limit the number of connected input/output or output ports to reduce the amount of data the Aggregator transformation stores in the data cache.

Filter the data before aggregating it.

If you use a Filter transformation in the mapping, place the transformation before the Aggregator transformation to reduce unnecessary aggregation.

Troubleshooting Aggregator Transformations

I selected sorted input but the workflow takes the same amount of time as before.

You cannot use sorted input if any of the following conditions are true:

- The aggregate expression contains nested aggregate functions.
- The session uses incremental aggregation.
- Source data is data driven.

When any of these conditions are true, the Integration Service processes the transformation as if you do not use sorted input.

A session using an Aggregator transformation causes slow performance.

The Integration Service may be paging to disk during the workflow. You can increase session performance by increasing the index and data cache sizes in the transformation properties.

I entered an override cache directory in the Aggregator transformation, but the Integration Service saves the session incremental aggregation files somewhere else.

You can override the transformation cache directory on a session level. The Integration Service notes the cache directory in the session log. You can also check the session properties for an override cache directory.

CHAPTER 3

Custom Transformation

This chapter includes the following topics:

- [Custom Transformation Overview, 59](#)
- [Creating Custom Transformations, 61](#)
- [Working with Groups and Ports, 62](#)
- [Working with Port Attributes, 64](#)
- [Custom Transformation Properties, 64](#)
- [Working with Transaction Control, 67](#)
- [Blocking Input Data, 68](#)
- [Working with Procedure Properties, 70](#)
- [Creating Custom Transformation Procedures, 70](#)

Custom Transformation Overview

Custom transformations operate in conjunction with procedures you create outside of the Designer interface to extend PowerCenter functionality. You can create a Custom transformation and bind it to a procedure that you develop using the Custom transformation functions. The Custom transformation can be an active or passive transformation.

Use the Custom transformation to create transformation applications, such as sorting and aggregation, which require all input rows to be processed before outputting any output rows. To support this process, the input and output functions occur separately in Custom transformations compared to External Procedure transformations.

The Integration Service passes the input data to the procedure using an input function. The output function is a separate function that you must enter in the procedure code to pass output data to the Integration Service. In contrast, in the External Procedure transformation, an external procedure function does both input and output, and its parameters consist of all the ports of the transformation.

You can also use the Custom transformation to create a transformation that requires multiple input groups, multiple output groups, or both. A group is the representation of a row of data entering or leaving a transformation. For example, you might create a Custom transformation with one input group and multiple output groups that parses XML data. Or, you can create a Custom transformation with two input groups and one output group that merges two streams of input data into one stream of output data.

Working with Transformations Built On the Custom Transformation

You can build transformations using the Custom transformation. Some of the PowerCenter transformations are built using the Custom transformation. The following transformations that ship with Informatica products are native transformations and are *not built* using the Custom transformation:

- Aggregator transformation
- Expression transformation
- External Procedure transformation
- Filter transformation
- Joiner transformation
- Lookup transformation
- Normalizer transformation
- Rank transformation
- Router transformation
- Sequence Generator transformation
- Sorter transformation
- Source Qualifier transformation
- Stored Procedure transformation
- Transaction Control transformation
- Update Strategy transformation

All other transformations are built using the Custom transformation. Rules that apply to Custom transformations, such as blocking rules, also apply to transformations built using Custom transformations. For example, when you connect a Custom transformation in a mapping, you must verify that the data can flow from all sources in a target load order group to the targets without the Integration Service blocking all sources. Similarly, you must also verify this for transformations built using a Custom transformation.

Code Page Compatibility

When the Integration Service runs in ASCII mode, it passes data to the Custom transformation procedure in ASCII. When the Integration Service runs in Unicode mode, it passes data to the procedure in UCS-2.

Use the `INFA_CTChangeStringMode()` and `INFA_CTSetDataCodePageID()` functions in the Custom transformation procedure code to request the data in a different format or in a different code page.

The functions you can use depend on the data movement mode of the Integration Service:

- **ASCII mode.** Use the `INFA_CTChangeStringMode()` function to request the data in UCS-2. When you use this function, the procedure must pass only ASCII characters in UCS-2 format to the Integration Service. You cannot use the `INFA_CTSetDataCodePageID()` function to change the code page when the Integration Service runs in ASCII mode.
- **Unicode mode.** Use the `INFA_CTChangeStringMode()` function to request the data in MBCS (multi-byte character set). When the procedure requests the data in MBCS, the Integration Service passes data in the Integration Service code page. Use the `INFA_CTSetDataCodePageID()` function to request the data in a different code page from the Integration Service code page. The code page you specify in the `INFA_CTSetDataCodePageID()` function must be two-way compatible with the Integration Service code page.

Note: You can also use the `INFA_CTRebindInputDataType()` function to change the format for a specific port in the Custom transformation.

Distributing Custom Transformation Procedures

You can copy a Custom transformation from one repository to another. When you copy a Custom transformation between repositories, you must verify that the Integration Service machine the target repository uses contains the Custom transformation procedure.

Creating Custom Transformations

You can create reusable Custom transformations in the Transformation Developer, and add instances of the transformation to mappings. You can create non-reusable Custom transformations in the Mapping Designer or Mapplet Designer.

Each Custom transformation specifies a module and a procedure name. You can create a Custom transformation based on an existing shared library or DLL containing the procedure, or you can create a Custom transformation as the basis for creating the procedure. When you create a Custom transformation to use with an existing shared library or DLL, make sure you define the correct module and procedure name.

When you create a Custom transformation as the basis for creating the procedure, select the transformation and generate the code. The Designer uses the transformation properties when it generates the procedure code. It generates code in a single directory for all transformations sharing a common module name.

The Designer generates the following files:

- **m_<module_name>.c.** Defines the module. This file includes an initialization function, `m_<module_name>_moduleInit()` that lets you write code you want the Integration Service to run when it loads the module. Similarly, this file includes a deinitialization function, `m_<module_name>_moduleDeinit()`, that lets you write code you want the Integration Service to run before it unloads the module.
- **p_<procedure_name>.c.** Defines the procedure in the module. This file contains the code that implements the procedure logic, such as data cleansing or merging data.
- **makefile.aix, makefile.aix64, makefile.hpparisc64, makefile.linux, makefile.sol, and makefile.sol64.** Make files for the UNIX platforms except zLinux. Use `makefile.aix64` for 64-bit AIX platforms and `makefile.sol64` for 64-bit Solaris platforms.

Note: For zLinux, you need to update the `makefile.linux`. Add `-m64` to the `FLAGS` section. For example, `FLAGS=-Wall -fPIC -DUNIX -m64`.

Rules and Guidelines for Custom Transformations

Use the following rules and guidelines when you create a Custom transformation:

- Custom transformations are connected transformations. You cannot reference a Custom transformation in an expression.
- You can include multiple procedures in one module. For example, you can include an XML writer procedure and an XML parser procedure in the same module.
- You can bind one shared library or DLL to multiple Custom transformation instances if you write the procedure code to handle multiple Custom transformation instances.

- When you write the procedure code, you must make sure it does not violate basic mapping rules.
- The Custom transformation sends and receives high precision decimals as high precision decimals.
- Use multi-threaded code in Custom transformation procedures.

Custom Transformation Components

When you configure a Custom transformation, you define the following components:

- **Transformation tab.** You can rename the transformation and add a description on the Transformation tab.
- **Ports tab.** You can add and edit ports and groups to a Custom transformation. You can also define the input ports an output port depends on.
- **Port Attribute Definitions tab.** You can create user-defined port attributes for Custom transformation ports.
- **Properties tab.** You can define transformation properties such as module and function identifiers, transaction properties, and the runtime location.
- **Initialization Properties tab.** You can define properties that the external procedure uses at runtime, such as during initialization.
- **Metadata Extensions tab.** You can create metadata extensions to define properties that the procedure uses at runtime, such as during initialization.

Working with Groups and Ports

A Custom transformation has both input and output groups. It also can have input ports, output ports, and input/output ports. You create and edit groups and ports on the Ports tab of the Custom transformation. You can also define the relationship between input and output ports on the Ports tab.

Creating Groups and Ports

You can create multiple input groups and multiple output groups in a Custom transformation. You must create at least one input group and one output group. To create an input group, click the Create Input Group icon. To create an output group, click the Create Output Group icon. You can change the existing group names by typing in the group header. When you create a passive Custom transformation, you can only create one input group and one output group.

When you create a port, the Designer adds it below the currently selected row or group. A port can belong to the input group and the output group that appears immediately above it. An input/output port that appears below the input group it is also part of the output group. An input/output port that appears below the output group it is also part of the input group.

Groups that share ports are called a coupled group. Adjacent groups of opposite type can share ports. One group can be part of more than one coupled group. For example, in the figure in [“Step 1. Create the Custom Transformation” on page 71](#), InputGroup1 and OutputGroup1 is a coupled group that shares ORDER_ID1

If the transformation has a Port Attribute Definitions tab, you can edit the attributes for each port.

Editing Groups and Ports

Use the following rules and guidelines when you edit ports and groups in a Custom transformation:

- You can change group names by typing in the group header.
- You can only enter ASCII characters for port and group names.
- Once you create a group, you cannot change the group type. If you need to change the group type, delete the group and add a new group.
- When you delete a group, the Designer deletes all ports of the same type in that group. However, all input/output ports remain in the transformation, belong to the group above them, and change to input ports or output ports, depending on the type of group you delete. For example, an output group contains output ports and input/output ports. You delete the output group. The Designer deletes the output ports. It changes the input/output ports to input ports. Those input ports belong to the input group with the header directly above them.
- To move a group up or down, select the group header and click the Move Port Up or Move Port Down button. The ports above and below the group header remain the same, but the groups to which they belong might change.
- To create an input/output port, the transformation must have an input group and an output group.

Defining Port Relationships

By default, an output port in a Custom transformation depends on all input ports. However, you can define the relationship between input and output ports in a Custom transformation. When you do this, you can view link paths in a mapping containing a Custom transformation and you can see which input ports an output port depends on. You can also view source column dependencies for target ports in a mapping containing a Custom transformation.

To define the relationship between ports in a Custom transformation, create a port dependency. A port dependency is the relationship between an output or input/output port and one or more input or input/output ports. When you create a port dependency, base it on the procedure logic in the code.

To create a port dependency, click Custom Transformation on the Ports tab and choose Port Dependencies.

For example, create an external procedure that parses XML data. You create a Custom transformation with one input group containing one input port and multiple output groups containing multiple output ports. According to the external procedure logic, all output ports depend on the input port. You can define this relationship in the Custom transformation by creating a port dependency for each output port. Define each port dependency so that the output port depends on the one input port.

To create a port dependency:

1. On the Ports tab, click Custom Transformation and choose Port Dependencies.
2. In the Output Port Dependencies dialog box, select an output or input/output port in the Output Port field.
3. In the Input Ports pane, select an input or input/output port on which the output port or input/output port depends.
4. Click Add.
5. Repeat steps [3](#) to [4](#) to include more input or input/output ports in the port dependency.
6. To create another port dependency, repeat steps [2](#) to [5](#).
7. Click OK.

Working with Port Attributes

Ports have attributes, such as datatype and precision. When you create a Custom transformation, you can create user-defined port attributes. User-defined port attributes apply to all ports in a Custom transformation.

For example, you create an external procedure to parse XML data. You can create a port attribute called “XML path” where you can define the position of an element in the XML hierarchy.

Create port attributes and assign default values on the Port Attribute Definitions tab of the Custom transformation. You can define a specific port attribute value for each port on the Ports tab.

When you create a port attribute, define the following properties:

- **Name.** The name of the port attribute.
- **Datatype.** The datatype of the port attribute value. You can choose Boolean, Numeric, or String.
- **Value.** The default value of the port attribute. This property is optional. When you enter a value here, the value applies to all ports in the Custom transformation. You can override the port attribute value for each port on the Ports tab.

You define port attributes for each Custom transformation. You cannot copy a port attribute from one Custom transformation to another.

Editing Port Attribute Values

After you create port attributes, you can edit the port attribute values for each port in the transformation. To edit the port attribute values, click Custom Transformation on the Ports tab and choose Edit Port Attribute.

You can change the port attribute value for a particular port by clicking the Open button. This opens the Edit Port Attribute Default Value dialog box. Or, you can enter a new value by typing directly in the Value column.

You can filter the ports listed in the Edit Port Level Attributes dialog box by choosing a group from the Select Group field.

Custom Transformation Properties

Properties for the Custom transformation apply to both the procedure and the transformation. Configure the Custom transformation properties on the Properties tab of the Custom transformation.

The following table describes the Custom transformation properties:

Option	Description
Language	Language used for the procedure code. You define the language when you create the Custom transformation. If you need to change the language, create a new Custom transformation.
Module Identifier	Module name. Applies to Custom transformation procedures developed using C or C++. Enter only ASCII characters in this field. You cannot enter multibyte characters. This property is the base name of the DLL or the shared library that contains the procedure. The Designer uses this name to create the C file when you generate the external procedure code.

Option	Description
Function Identifier	<p>Name of the procedure in the module. Applies to Custom transformation procedures developed using C.</p> <p>Enter only ASCII characters in this field. You cannot enter multibyte characters.</p> <p>The Designer uses this name to create the C file where you enter the procedure code.</p>
Class Name	<p>Class name of the Custom transformation procedure. Applies to Custom transformation procedures developed using C++ or Java.</p> <p>Enter only ASCII characters in this field. You cannot enter multibyte characters.</p>
Runtime Location	<p>Location that contains the DLL or shared library. Default is \$PMExtProcDir. Enter a path relative to the Integration Service node that runs the Custom transformation session.</p> <p>If this property is blank, the Integration Service uses the environment variable defined on the Integration Service node to locate the DLL or shared library.</p> <p>You must copy all DLLs or shared libraries to the runtime location or to the environment variable defined on the Integration Service node. The Integration Service fails to load the procedure when it cannot locate the DLL, shared library, or a referenced file.</p>
Tracing Level	<p>Amount of detail displayed in the session log for this transformation. Default is Normal.</p>
Is Partitionable	<p>Indicates if you can create multiple partitions in a pipeline that uses this transformation:</p> <ul style="list-style-type: none"> - No. The transformation cannot be partitioned. The transformation and other transformations in the same pipeline are limited to one partition. - Locally. The transformation can be partitioned, but the Integration Service must run all partitions in the pipeline on the same node. Choose Local when different partitions of the Custom transformation must share objects in memory. - Across Grid. The transformation can be partitioned, and the Integration Service can distribute each partition to different nodes. <p>Default is No.</p>
Inputs Must Block	<p>Indicates if the procedure associated with the transformation must be able to block incoming data. Default is enabled.</p>
Is Active	<p>Indicates if this transformation is an active or passive transformation.</p> <p>You cannot change this property after you create the Custom transformation. If you need to change this property, create a new Custom transformation and select the correct property value.</p>
Update Strategy Transformation	<p>Indicates if this transformation defines the update strategy for output rows. Default is disabled. You can enable this for active Custom transformations.</p>
Transformation Scope	<p>Indicates how the Integration Service applies the transformation logic to incoming data:</p> <ul style="list-style-type: none"> - Row - Transaction - All Input <p>When the transformation is passive, this property is always Row. When the transformation is active, this property is All Input by default.</p>
Generate Transaction	<p>Indicates if this transformation can generate transactions. When a Custom transformation generates transactions, it generates transactions for all output groups.</p> <p>Default is disabled. You can only enable this for active Custom transformations.</p>

Option	Description
Output is Repeatable	<p>Indicates if the <i>order</i> of the output data is consistent between session runs.</p> <ul style="list-style-type: none"> - Never. The order of the output data is inconsistent between session runs. This is the default for active transformations. - Based On Input Order. The output order is consistent between session runs when the input data order is consistent between session runs. This is the default for passive transformations. - Always. The order of the output data is consistent between session runs even if the order of the input data is inconsistent between session runs.
Requires Single Thread Per Partition	<p>Indicates if the Integration Service processes each partition at the procedure with one thread. When you enable this option, the procedure code can use thread-specific operations. Default is enabled.</p>
Output is Deterministic	<p>Indicates whether the transformation generates consistent output data between session runs. Enable this property to perform recovery on sessions that use this transformation.</p>

Warning: If you configure a transformation as repeatable and deterministic, it is your responsibility to ensure that the data is repeatable and deterministic. If you try to recover a session with transformations that do not produce the same data between the session and the recovery, the recovery process can result in corrupted data.

Setting the Update Strategy

Use an active Custom transformation to set the update strategy for a mapping at the following levels:

- **Within the procedure.** You can write the external procedure code to set the update strategy for output rows. The external procedure can flag rows for insert, update, delete, or reject.
- **Within the mapping.** Use the Custom transformation in a mapping to flag rows for insert, update, delete, or reject. Select the Update Strategy Transformation property for the Custom transformation.
- **Within the session.** Configure the session to treat the source rows as data driven.

If you do not configure the Custom transformation to define the update strategy, or you do not configure the session as data driven, the Integration Service does not use the external procedure code to flag the output rows. Instead, when the Custom transformation is active, the Integration Service flags the output rows as insert. When the Custom transformation is passive, the Integration Service retains the row type. For example, when a row flagged for update enters a passive Custom transformation, the Integration Service maintains the row type and outputs the row as update.

Working with Thread-Specific Procedure Code

Custom transformation procedures can include thread-specific operations. A thread-specific operation is code that performs an action based on the thread that is processing the procedure.

You can configure the Custom transformation so the Integration Service uses one thread to process the Custom transformation for each partition using the Requires Single Thread Per Partition property.

When you configure a Custom transformation to process each partition with one thread, the Integration Service calls the following functions with the same thread for each partition:

- p_<proc_name>_partitionInit()
- p_<proc_name>_partitionDeinit()
- p_<proc_name>_inputRowNotification()

- p_<proc_name>_dataBdryRowNotification()
- p_<proc_name>_eofNotification()

You can include thread-specific operations in these functions because the Integration Service uses the same thread to process these functions for each partition. For example, you might attach and detach threads to a Java Virtual Machine.

Note: When you configure a Custom transformation to process each partition with one thread, the Workflow Manager adds partition points depending on the mapping configuration.

Working with Transaction Control

You can define transaction control for Custom transformations using the following transformation properties:

- **Transformation Scope.** Determines how the Integration Service applies the transformation logic to incoming data.
- **Generate Transaction.** Indicates that the procedure generates transaction rows and outputs them to the output groups.

Transformation Scope

You can configure how the Integration Service applies the transformation logic to incoming data. You can choose one of the following values:

- **Row.** Applies the transformation logic to one row of data at a time. Choose Row when the results of the procedure depend on a single row of data. For example, you might choose Row when a procedure parses a row containing an XML file.
- **Transaction.** Applies the transformation logic to all rows in a transaction. Choose Transaction when the results of the procedure depend on all rows in the same transaction, but not on rows in other transactions. When you choose Transaction, you must connect all input groups to the same transaction control point. For example, you might choose Transaction when the external procedure performs aggregate calculations on the data in a single transaction.
- **All Input.** Applies the transformation logic to all incoming data. When you choose All Input, the Integration Service drops transaction boundaries. Choose All Input when the results of the procedure depend on all rows of data in the source. For example, you might choose All Input when the external procedure performs aggregate calculations on all incoming data, or when it sorts all incoming data.

Generate Transaction

You can write the external procedure code to output transactions, such as commit and rollback rows. When the external procedure outputs commit and rollback rows, configure the Custom transformation to generate transactions. Select the Generate Transaction transformation property. You can enable this property for active Custom transformations.

When the external procedure outputs a commit or rollback row, it outputs or rolls back the row for all output groups.

When you configure the transformation to generate transactions, the Integration Service treats the Custom transformation like a Transaction Control transformation. Most rules that apply to a Transaction Control transformation in a mapping also apply to the Custom transformation. For example, when you configure a

Custom transformation to generate transactions, you cannot concatenate pipelines or pipeline branches containing the transformation.

When you edit or create a session using a Custom transformation configured to generate transactions, configure it for user-defined commit.

Working with Transaction Boundaries

The Integration Service handles transaction boundaries entering and leaving Custom transformations based on the mapping configuration and the Custom transformation properties.

The following table describes how the Integration Service handles transaction boundaries at Custom transformations:

Transformation Scope	Generate Transactions Enabled	Generate Transactions Disabled
Row	Integration Service drops incoming transaction boundaries and does not call the data boundary notification function. It outputs transaction rows according to the procedure logic across all output groups.	When the incoming data for all input groups comes from the same transaction control point, the Integration Service preserves incoming transaction boundaries and outputs them across all output groups. However, it does not call the data boundary notification function. When the incoming data for the input groups comes from different transaction control points, the Integration Service drops incoming transaction boundaries. It does not call the data boundary notification function. The Integration Service outputs all rows in one open transaction.
Transaction	Integration Service preserves incoming transaction boundaries and calls the data boundary notification function. However, it outputs transaction rows according to the procedure logic across all output groups.	Integration Service preserves incoming transaction boundaries and calls the data boundary notification function. It outputs the transaction rows across all output groups.
All Input	Integration Service drops incoming transaction boundaries and does not call the data boundary notification function. The Integration Service outputs transaction rows according to the procedure logic across all output groups.	Integration Service drops incoming transaction boundaries and does not call the data boundary notification function. It outputs all rows in one open transaction.

Blocking Input Data

By default, the Integration Service concurrently reads sources in a target load order group. However, you can write the external procedure code to block input data on some input groups. Blocking is the suspension of the data flow into an input group of a multiple input group transformation.

To use a Custom transformation to block input data, you must write the procedure code to block and unblock data. You must also enable blocking on the Properties tab for the Custom transformation.

Writing the Procedure Code to Block Data

You can write the procedure to block and unblock incoming data. To block incoming data, use the `INFA_CTBlockInputFlow()` function. To unblock incoming data, use the `INFA_CTUnblockInputFlow()` function.

You might want to block input data if the external procedure needs to alternate reading from input groups. Without the blocking functionality, you would need to write the procedure code to buffer incoming data. You can block input data instead of buffering it which usually increases session performance.

For example, you need to create an external procedure with two input groups. The external procedure reads a row from the first input group and then reads a row from the second input group. If you use blocking, you can write the external procedure code to block the flow of data from one input group while it processes the data from the other input group. When you write the external procedure code to block data, you increase performance because the procedure does not need to copy the source data to a buffer. However, you could write the external procedure to allocate a buffer and copy the data from one input group to the buffer until it is ready to process the data. Copying source data to a buffer decreases performance.

RELATED TOPICS:

- [“Blocking Functions” on page 111](#)

Configuring Custom Transformations as Blocking Transformations

When you create a Custom transformation, the Designer enables the Inputs Must Block transformation property by default. This property affects data flow validation when you save or validate a mapping. When you enable this property, the Custom transformation is a blocking transformation. When you clear this property, the Custom transformation is not a blocking transformation.

Configure the Custom transformation as a blocking transformation when the external procedure code *must* be able to block input data.

You can configure the Custom transformation as a non-blocking transformation when one of the following conditions is true:

- The procedure code does not include the blocking functions.
- The procedure code includes two algorithms, one that uses blocking and the other that copies the source data to a buffer allocated by the procedure instead of blocking data. The code checks whether or not the Integration Service allows the Custom transformation to block data. The procedure uses the algorithm with the blocking functions when it can block, and uses the other algorithm when it cannot block. You might want to do this to create a Custom transformation that you use in multiple mapping configurations.

Note: When the procedure blocks data and you configure the Custom transformation as a non-blocking transformation, the Integration Service fails the session.

Validating Mappings with Custom Transformations

When you include a Custom transformation in a mapping, both the Designer and Integration Service validate the mapping. The Designer validates the mapping you save or validate and the Integration Service validates the mapping when you run the session.

Validating at Design Time

When you save or validate a mapping, the Designer performs data flow validation. When the Designer does this, it verifies that the data can flow from all sources in a target load order group to the targets without blocking transformations blocking *all* sources. Some mappings with blocking transformations are invalid.

Validating at Runtime

When you run a session, the Integration Service validates the mapping against the procedure code at runtime. When the Integration Service does this, it tracks whether or not it allows the Custom transformations to block data:

- **Configure the Custom transformation as a blocking transformation.** The Integration Service always allows the Custom transformation to block data.
- **Configure the Custom transformation as a non-blocking transformation.** The Integration Service allows the Custom transformation to block data depending on the mapping configuration. If the Integration Service can block data at the Custom transformation without blocking all sources in the target load order group simultaneously, it allows the Custom transformation to block data.

You can write the procedure code to check whether or not the Integration Service allows a Custom transformation to block data. Use the `INFA_CT_getInternalProperty()` function to access the `INFA_CT_TRANS_MAY_BLOCK_DATA` property ID. The Integration Service returns `TRUE` when the Custom transformation can block data, and it returns `FALSE` when the Custom transformation cannot block data.

Working with Procedure Properties

You can define property name and value pairs in the Custom transformation that the procedure can use when the Integration Service runs the procedure, such as during initialization time. You can create user-defined properties on the following tabs of the Custom transformation:

- **Metadata Extensions.** You can specify the property name, datatype, precision, and value. Use metadata extensions for passing information to the procedure.
- **Initialization Properties.** You can specify the property name and value.

While you can define properties on both tabs in the Custom transformation, the Metadata Extensions tab lets you provide more detail for the property. Use metadata extensions to pass properties to the procedure.

For example, you create a Custom transformation external procedure that sorts data after transforming it. You could create a boolean metadata extension named `Sort_Ascending`. When you use the Custom transformation in a mapping, you can choose `True` or `False` for the metadata extension, depending on how you want the procedure to sort the data.

When you define a property in the Custom transformation, use the get all property names functions, such as `INFA_CT_GetAllPropertyNamesM()`, to access the names of all properties defined on the Initialization Properties and Metadata Extensions tab. Use the get external property functions, such as `INFA_CT_getExternalPropertyM()`, to access the property name and value of a property ID you specify.

Note: When you define a metadata extension and an initialization property with the same name, the property functions only return information for the metadata extension.

Creating Custom Transformation Procedures

You can create Custom transformation procedures that run on 32-bit or 64-bit Integration Service machines. Use the following steps as a guideline when you create a Custom transformation procedure:

1. In the Transformation Developer, create a reusable Custom transformation. Or, in the Mapplet Designer or Mapping Designer, create a non-reusable Custom transformation.

2. Generate the template code for the procedure.

When you generate the procedure code, the Designer uses the information from the Custom transformation to create C source code files and makefiles.

3. Modify the C files to add the procedure logic.
4. Use a C/C++ compiler to compile and link the source code files into a DLL or shared library and copy it to the Integration Service machine.
5. Create a mapping with the Custom transformation.
6. Run the session in a workflow.

This section includes an example to demonstrate this process. The steps in this section create a Custom transformation that contains two input groups and one output group. The Custom transformation procedure verifies that the Custom transformation uses two input groups and one output group. It also verifies that the number of ports in all groups are equal and that the port datatypes are the same for all groups. The procedure takes rows of data from each input group and outputs all rows to the output group.

Step 1. Create the Custom Transformation

To create a Custom transformation:

1. In the Transformation Developer, click Transformation > Create.
2. In the Create Transformation dialog box, choose Custom transformation, enter a transformation name, and click Create.
In the Union example, enter `CT_Inf_Union` as the transformation name.
3. In the Active or Passive dialog box, create the transformation as a passive or active transformation, and click OK.
In the Union example, choose Active.
4. Click Done to close the Create Transformation dialog box.
5. Open the transformation and click the Ports tab. Create groups and ports.
You can edit the groups and ports later, if necessary.

The following figure shows an example of a Union transformation with two groups:

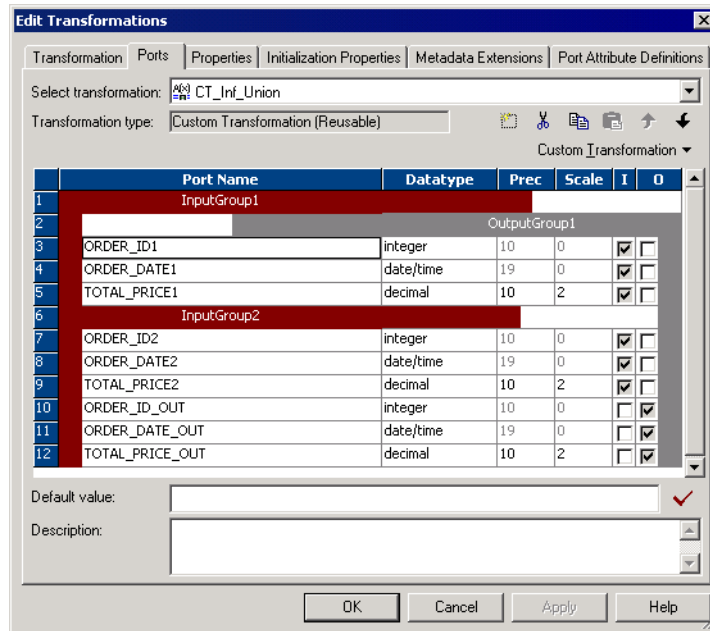

In the Union example, create the groups InputGroup1 and InputGroup2. Create the following ports for InputGroup1:

Port Name	Datatype	Precision	Scale
ORDER_ID1	integer	10	0
ORDER_DATE1	date/time	19	0
TOTAL_PRICE1	decimal	10	2

Create the following ports for InputGroup2:

Port Name	Datatype	Precision	Scale	Input/Output
ORDER_ID2	integer	10	0	Input
ORDER_DATE2	date/time	19	0	Input
TOTAL_PRICE2	decimal	10	2	Input
ORDER_ID_OUT	integer	10	0	Output
ORDER_DATE_OUT	date/time	19	0	Output
TOTAL_PRICE_OUT	decimal	10	2	Output

6. Select the Properties tab and enter a module and function identifier and the runtime location. Edit other transformation property attributes, such as the Tracing Level, Is Partitionable, Inputs Must Block, Is

Active, Update Strategy Transformation, Transformation Scope and Generate Transaction values/checkboxes.

In the Union example, configure the following properties:

Property Name	Value
Module Identifier	UnionDemo
Function Identifier	Union
Runtime Location	\$PMEExtProcDir
Tracing Level	Normal
Is Partitionable	No
Inputs Must Block	No
Is Active	Yes
Update Strategy Transformation	No
Transformation Scope	All Input
Generate Transaction	No

7. Click the Metadata Extensions tab to enter metadata extensions, such as properties the external procedure might need for initialization.

In the Union example, do not create metadata extensions.

8. Click the Port Attribute Definitions tab to create port attributes, if necessary.

In the Union example, do not create port attributes.

After you create the Custom transformation that calls the procedure, the next step is to generate the C files.

Step 2. Generate the C Files

After you create a Custom transformation, you generate the source code files. The Designer generates file names in lower case.

To generate the code for a Custom transformation procedure:

1. In the Transformation Developer, select the transformation and click Transformation > Generate Code.
2. Select the procedure you just created. The Designer lists the procedures as <module_name>.<procedure_name>.

In the Union example, select UnionDemo.Union.

3. Specify the directory where you want to generate the files, and click Generate.

In the Union example, select <client_installation_directory>/TX.

The Designer creates a subdirectory, <module_name>, in the directory you specified. In the Union example, the Designer creates <client_installation_directory>/TX/UnionDemo. It also creates the following files:

- m_UnionDemo.c
- m_UnionDemo.h
- p_Union.c
- p_Union.h
- makefile.aix (32-bit), makefile.aix64 (64-bit), makefile.hp (32-bit), makefile.hp64 (64-bit), makefile.hpparisc64, makefile.linux (32-bit), and makefile.sol (32-bit).

Step 3. Fill Out the Code with the Transformation Logic

You must code the procedure C file. Optionally, you can also code the module C file. In the Union example, you fill out the procedure C file only. You do not need to fill out the module C file.

To code the procedure C file:

1. Open p_<procedure_name>.c for the procedure.
In the Union example, open p_Union.c.
2. Enter the C code for the procedure.
3. Save the modified file.

In the Union example, use the following code:

```

/*****
 * Custom Transformation p_union Procedure File
 *
 * This file contains code that functions that will be called by the main
 * server executable.
 *
 * for more information on these files,
 * see $(INFA_HOME)/ExtProc/include/Readme.txt
 *****/

/*
 * INFORMATICA 'UNION DEMO' developed using the API for custom
 * transformations.

 * File Name: p_Union.c
 *
 * An example of a custom transformation ('Union') using PowerCenter
 *
 * The purpose of the 'Union' transformation is to combine pipelines with the
 * same row definition into one pipeline (i.e. union of multiple pipelines).
 * [ Note that it does not correspond to the mathematical definition of union
 * since it does not eliminate duplicate rows.]
 *
 * This example union transformation allows N input pipelines ( each
 * corresponding to an input group) to be combined into one pipeline.
 *
 * To use this transformation in a mapping, the following attributes must be
 * true:
 * a. The transformation must have >= 2 input groups and only one output group.
 * b. In the Properties tab set the following properties:
 *     i. Module Identifier: UnionDemo
 *     ii. Function Identifier: Union
 *     iii. Inputs May Block: Unchecked
 *     iv. Is Active: Checked
 *     v. Update Strategy Transformation: Unchecked *
 *     vi. Transformation Scope: All
 *     vii. Generate Transaction: Unchecked *

```

```

*
*   * This version of the union transformation does not provide code for
*   changing the update strategy or for generating transactions.
* c. The input groups and the output group must have the same number of ports
* and the same datatypes. This is verified in the initialization of the
* module and the session is failed if this is not true.
* d. The transformation can be used in multiple number of times in a Target
* Load Order Group and can also be contained within multiple partitions.
*
*/

/*****
                               Includes
*****/

include <stdlib.h>
#include "p_union.h"

/*****
                               Forward Declarations
*****/
INFA_STATUS validateProperties(const INFA_CT_PARTITION_HANDLE* partition);

/*****
                               Functions
*****/

/*****
Function: p_union_procInit

Description: Initialization for the procedure. Returns INFA_SUCCESS if
procedure initialization succeeds, else return INFA_FAILURE.

Input: procedure - the handle for the procedure
Output: None
Remarks: This function will get called once for the session at
initialization time. It will be called after the moduleInit function.
*****/

INFA_STATUS p_union_procInit( INFA_CT_PROCEDURE_HANDLE procedure)
{
    const INFA_CT_TRANSFORMATION_HANDLE* transformation = NULL;
    const INFA_CT_PARTITION_HANDLE* partition = NULL;
    size_t nTransformations = 0, nPartitions = 0, i = 0;

    /* Log a message indicating beginning of the procedure initialization */
    INFA_CTLogMessageM( eESL_LOG,
                      "union_demo: Procedure initialization started ..." );

    INFA_CTChangeStringMode( procedure, eASM_MBCS );

    /* Get the transformation handles */
    transformation = INFA_CTGetChildrenHandles( procedure,
                                                &nTransformations,
                                                TRANSFORMATIONTYPE);

    /* For each transformation verify that the 0th partition has the correct
     * properties. This does not need to be done for all partitions since rest
     * of the partitions have the same information */
    for (i = 0; i < nTransformations; i++)
    {
        /* Get the partition handle */
        partition = INFA_CTGetChildrenHandles( transformation[i],
                                                &nPartitions, PARTITIONTYPE );

        if (validateProperties(partition) != INFA_SUCCESS)
        {
            INFA_CTLogMessageM( eESL_ERROR,
                              "union_demo: Failed to validate attributes of "
                              "the transformation");
        }
    }
}

```

```

        return INFA_FAILURE;
    }
}

INFA_CTLogMessageM( eESL_LOG,
    "union_demo: Procedure initialization completed." );

return INFA_SUCCESS;
}

/*****
Function: p_union_procDeinit

Description: Deinitialization for the procedure. Returns INFA_SUCCESS if
procedure deinitialization succeeds, else return INFA_FAILURE.

Input: procedure - the handle for the procedure
Output: None
Remarks: This function will get called once for the session at
deinitialization time. It will be called before the moduleDeinit
function.
*****/

INFA_STATUS p_union_procDeinit( INFA_CT_PROCEDURE_HANDLE procedure,
    INFA_STATUS sessionStatus )
{
    /* Do nothing ... */
    return INFA_SUCCESS;
}

/*****
Function: p_union_partitionInit

Description: Initialization for the partition. Returns INFA_SUCCESS if
partition deinitialization succeeds, else return INFA_FAILURE.

Input: partition - the handle for the partition
Output: None
Remarks: This function will get called once for each partition for each
transformation in the session.
*****/

INFA_STATUS p_union_partitionInit( INFA_CT_PARTITION_HANDLE partition )
{
    /* Do nothing ... */
    return INFA_SUCCESS;
}

/*****
Function: p_union_partitionDeinit

Description: Deinitialization for the partition. Returns INFA_SUCCESS if
partition deinitialization succeeds, else return INFA_FAILURE.

Input: partition - the handle for the partition
Output: None
Remarks: This function will get called once for each partition for each
transformation in the session.
*****/

INFA_STATUS p_union_partitionDeinit( INFA_CT_PARTITION_HANDLE partition )
{
    /* Do nothing ... */
    return INFA_SUCCESS;
}

/*****
Function: p_union_inputRowNotification

Description: Notification that a row needs to be processed for an input

```

group in a transformation for the given partition. Returns INFA_ROWSUCCESS if the input row was processed successfully, INFA_ROWFAILURE if the input row was not processed successfully and INFA_FATALERROR if the input row causes the session to fail.

Input: partition - the handle for the partition for the given row
group - the handle for the input group for the given row

Output: None

Remarks: This function is probably where the meat of your code will go, as it is called for every row that gets sent into your transformation.

*****/

```
INFA_ROWSTATUS p_union_inputRowNotification( INFA_CT_PARTITION_HANDLE partition,
                                             INFA_CT_INPUTGROUP_HANDLE inputGroup )
```

```
{
    const INFA_CT_OUTPUTGROUP_HANDLE* outputGroups = NULL;
    const INFA_CT_INPUTPORT_HANDLE* inputGroupPorts = NULL;
    const INFA_CT_OUTPUTPORT_HANDLE* outputGroupPorts = NULL;
    size_t nNumInputPorts = 0, nNumOutputGroups = 0,
          nNumPortsInOutputGroup = 0, i = 0;

    /* Get the output group port handles */
    outputGroups = INFA_CTGetChildrenHandles(partition,
                                             &nNumOutputGroups,
                                             OUTPUTGROUPTYPE);

    outputGroupPorts = INFA_CTGetChildrenHandles(outputGroups[0],
                                                &nNumPortsInOutputGroup,
                                                OUTPUTPORTTYPE);

    /* Get the input groups port handles */
    inputGroupPorts = INFA_CTGetChildrenHandles(inputGroup,
                                                &nNumInputPorts,
                                                INPUTPORTTYPE);

    /* For the union transformation, on receiving a row of input, we need to
     * output that row on the output group. */
    for (i = 0; i < nNumInputPorts; i++)
    {
        INFA_CTSetData(outputGroupPorts[i],
                      INFA_CTGetDataVoid(inputGroupPorts[i]));

        INFA_CTSetIndicator(outputGroupPorts[i],
                          INFA_CTGetIndicator(inputGroupPorts[i]) );

        INFA_CTSetLength(outputGroupPorts[i],
                        INFA_CTGetLength(inputGroupPorts[i]) );
    }

    /* We know there is only one output group for each partition */
    return INFA_CTOutputNotification(outputGroups[0]);
}
```

```
/******
Function: p_union_eofNotification
```

Description: Notification that the last row for an input group has already been seen. Return INFA_FAILURE if the session should fail as a result of seeing this notification, INFA_SUCCESS otherwise.

Input: partition - the handle for the partition for the notification
group - the handle for the input group for the notification

Output: None

*****/

```
INFA_STATUS p_union_eofNotification( INFA_CT_PARTITION_HANDLE partition,
                                     INFA_CT_INPUTGROUP_HANDLE group)
```

```
{
    INFA_CTLogMessageM( eESL_LOG,
```

```

        "union_demo: An input group received an EOF notification");

    return INFA_SUCCESS;
}

/*****
    Function: p_union_dataBdryNotification

    Description: Notification that a transaction has ended. The data
    boundary type can either be commit or rollback.
    Return INFA_FAILURE if the session should fail as a result of
    seeing this notification, INFA_SUCCESS otherwise.

    Input: partition - the handle for the partition for the notification
           transactionType - commit or rollback
    Output: None
    *****/

INFA_STATUS p_union_dataBdryNotification ( INFA_CT_PARTITION_HANDLE partition,
                                           INFA_CT_DATABDRY_TYPE transactionType)
{
    /* Do nothing */
    return INFA_SUCCESS;
}

/* Helper functions */

/*****
    Function: validateProperties

    Description: Validate that the transformation has all properties expected
    by a union transformation, such as at least one input group, and only
    one output group. Return INFA_FAILURE if the session should fail since the
    transformation was invalid, INFA_SUCCESS otherwise.

    Input: partition - the handle for the partition
    Output: None
    *****/

INFA_STATUS validateProperties(const INFA_CT_PARTITION_HANDLE* partition)
{
    const INFA_CT_INPUTGROUP_HANDLE* inputGroups = NULL;
    const INFA_CT_OUTPUTGROUP_HANDLE* outputGroups = NULL;
    size_t nNumInputGroups = 0, nNumOutputGroups = 0;
    const INFA_CT_INPUTPORT_HANDLE** allInputGroupsPorts = NULL;
    const INFA_CT_OUTPUTPORT_HANDLE* outputGroupPorts = NULL;
    size_t nNumPortsInOutputGroup = 0;
    size_t i = 0, nTempNumInputPorts = 0;

    /* Get the input and output group handles */
    inputGroups = INFA_CTGetChildrenHandles(partition[0],
                                           &nNumInputGroups,
                                           INPUTGROUPTYPE);

    outputGroups = INFA_CTGetChildrenHandles(partition[0],
                                           &nNumOutputGroups,
                                           OUTPUTGROUPTYPE);

    /* 1. Number of input groups must be >= 2 and number of output groups must
     * be equal to one. */
    if (nNumInputGroups < 1 || nNumOutputGroups != 1)
    {
        INFA_CTLogMessageM( eESL_ERROR,
                           "UnionDemo: There must be at least two input groups "
                           "and only one output group");
        return INFA_FAILURE;
    }

    /* 2. Verify that the same number of ports are in each group (including
     * output group). */

```

```

outputGroupPorts = INFA_CTGetChildrenHandles (outputGroups[0],
                                             &nNumPortsInOutputGroup,
                                             OUTPUTPORTTYPE);

/* Allocate an array for all input groups ports */
allInputGroupsPorts = malloc(sizeof(INFA_CT_INPUTPORT_HANDLE*) *
                             nNumInputGroups);

for (i = 0; i < nNumInputGroups; i++)
{
    allInputGroupsPorts[i] = INFA_CTGetChildrenHandles (inputGroups[i],
                                                       &nTempNumInputPorts,
                                                       INPUTPORTTYPE);

    if ( nNumPortsInOutputGroup != nTempNumInputPorts)
    {
        INFA_CTLogMessageM( eESL_ERROR,
                           "UnionDemo: The number of ports in all input and "
                           "the output group must be the same.");
        return INFA_FAILURE;
    }
}

free(allInputGroupsPorts);

/* 3. Datatypes of ports in input group 1 must match data types of all other
 * groups.
 * TODO:*/

return INFA_SUCCESS;
}

```

Step 4. Build the Module

You can build the module on a Windows or UNIX platform.

The following table lists the library file names for each platform when you build the module:

Platform	Module File Name
Windows	<module_identifier>.dll
AIX	lib<module_identifier>.a
Linux	lib<module_identifier>.so
Solaris	lib<module_identifier>.so

Building the Module on Windows

On Windows, use Microsoft Visual C++ to build the module.

To build the module on Windows:

1. Start Visual C++.
2. Click File > New.
3. In the New dialog box, click the Projects tab and select the Win32 Dynamic-Link Library option.
4. Enter its location.
In the Union example, enter <client_installation_directory>/TX/UnionDemo.
5. Enter the name of the project.

You must use the module name specified for the Custom transformation as the project name. In the Union example, enter UnionDemo.

6. Click OK.

Visual C++ creates a wizard to help you define the project components.

7. In the wizard, select An empty DLL project and click Finish. Click OK in the New Project Information dialog box.

Visual C++ creates the project files in the directory you specified.

8. Click Project > Add To Project > Files.

9. Navigate up a directory level. This directory contains the procedure files you created. Select all .c files and click OK.

In the Union example, add the following files:

- m_UnionDemo.c
- p_Union.c

10. Click Project > Settings.

11. Click the C/C++ tab, and select Preprocessor from the Category field.

12. In the Additional Include Directories field, enter the following path and click OK:

```
..; <PowerCenter_install_dir>\extproc\include\ct
```

13. Click Build > Build <module_name>.dll or press F7 to build the project.

Visual C++ creates the DLL and places it in the debug or release directory under the project directory.

Building the Module on UNIX

On UNIX, use any C compiler to build the module.

To build the module on UNIX:

1. Copy all C files and makefiles generated by the Designer to the UNIX machine.

Note: If you build the shared library on a machine other than the Integration Service machine, you must also copy the files in the following directory to the build machine:

```
<PowerCenter_install_dir>\ExtProc\include\ct
```

In the Union example, copy all files in <client_installation_directory>/TX/UnionDemo.

2. Set the environment variable INFA_HOME to the Integration Service installation directory.

Note: If you specify an incorrect directory path for the INFA_HOME environment variable, the Integration Service cannot start.

3. Enter a command from the following table to make the project:

UNIX Version	Command
AIX (32-bit)	make -f makefile.aix
AIX (64-bit)	make -f makefile.aix64
Linux	make -f makefile.linux
Solaris	make -f makefile.sol

Step 5. Create a Mapping

In the Mapping Designer, create a mapping that uses the Custom transformation.

In this mapping, two sources with the same ports and datatypes connect to the two input groups in the Custom transformation. The Custom transformation takes the rows from both sources and outputs them all through its one output group. The output group has the same ports and datatypes as the input groups.

In the Union example, create a mapping similar to the one in the following figure:

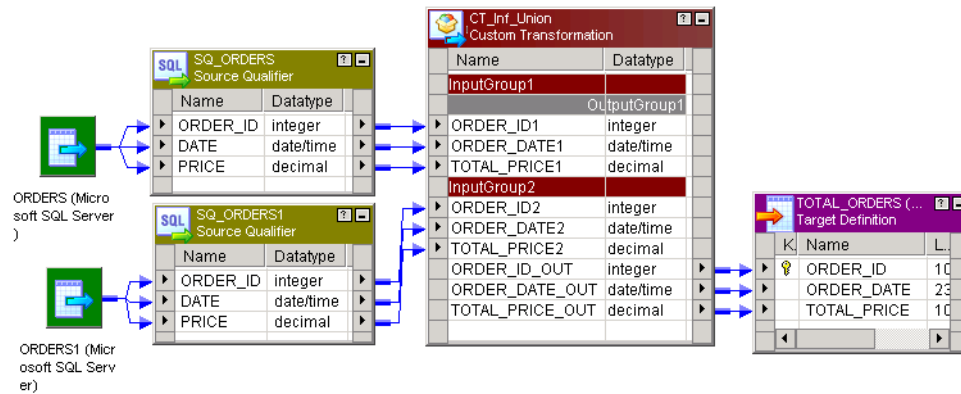

Step 6. Run the Session in a Workflow

When you run the session, the Integration Service looks for the shared library or DLL in the runtime location you specify in the Custom transformation.

To run a session in a workflow:

1. In the Workflow Manager, create a workflow.
2. Create a session for this mapping in the workflow.
3. Copy the shared library or DLL to the runtime location directory.
4. Run the workflow containing the session.

When the Integration Service loads a Custom transformation bound to a procedure, it loads the DLL or shared library and calls the procedure you define.

CHAPTER 4

Custom Transformation Functions

This chapter includes the following topics:

- [Custom Transformation Functions Overview, 82](#)
- [Function Reference, 83](#)
- [Working with Rows, 86](#)
- [Generated Functions, 87](#)
- [API Functions, 92](#)
- [Array-Based API Functions, 116](#)

Custom Transformation Functions Overview

Custom transformations operate in conjunction with procedures you create outside of the Designer to extend PowerCenter functionality. The Custom transformation functions allow you to develop the transformation logic in a procedure you associate with a Custom transformation. PowerCenter provides two sets of functions called generated and API functions. The Integration Service uses generated functions to interface with the procedure. When you create a Custom transformation and generate the source code files, the Designer includes the generated functions in the files. Use the API functions in the procedure code to develop the transformation logic.

When you write the procedure code, you can configure it to receive a block of rows from the Integration Service or a single row at a time. You can increase the procedure performance when it receives and processes a block of rows.

Working with Handles

Most functions are associated with a handle, such as `INFA_CT_PARTITION_HANDLE`. The first parameter for these functions is the handle the function affects. Custom transformation handles have a hierarchical relationship to each other. A parent handle has a 1:*n* relationship to its child handle.

The following figure shows the Custom transformation handles:

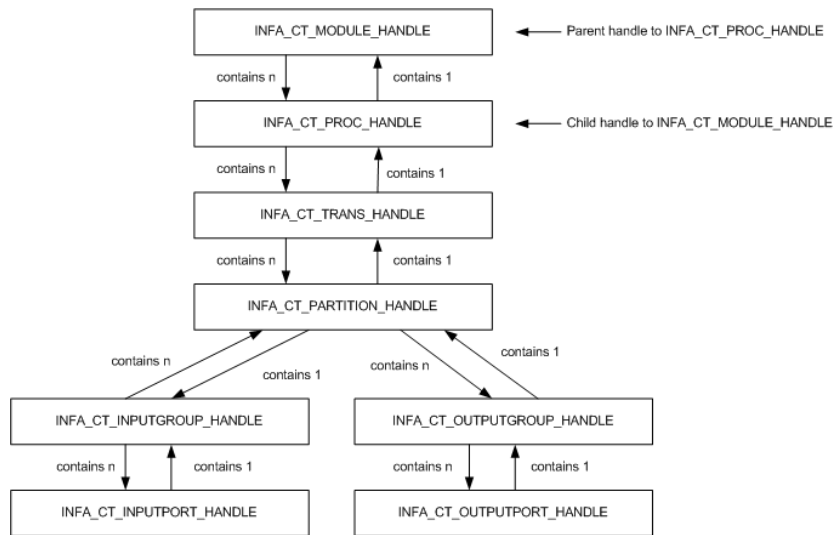

The following table describes the Custom transformation handles:

Handle Name	Description
INFA_CT_MODULE_HANDLE	Represents the shared library or DLL. The external procedure can only access the module handle in its own shared library or DLL. It cannot access the module handle in any other shared library or DLL.
INFA_CT_PROC_HANDLE	Represents a specific procedure within the shared library or DLL. You might use this handle when you need to write a function to affect a procedure referenced by multiple Custom transformations.
INFA_CT_TRANS_HANDLE	Represents a specific Custom transformation instance in the session.
INFA_CT_PARTITION_HANDLE	Represents a specific partition in a specific Custom transformation instance.
INFA_CT_INPUTGROUP_HANDLE	Represents an input group in a partition.
INFA_CT_INPUTPORT_HANDLE	Represents an input port in an input group in a partition.
INFA_CT_OUTPUTGROUP_HANDLE	Represents an output group in a partition.
INFA_CT_OUTPUTPORT_HANDLE	Represents an output port in an output group in a partition.

Function Reference

The Custom transformation functions include generated and API functions.

The following table lists the Custom transformation generated functions:

Function	Description
m_<module_name>_moduleInit()	Module initialization function.
p_<proc_name>_proclnit()	Procedure initialization function.
p_<proc_name>_partitionInit()	Partition initialization function.
p_<proc_name>_inputRowNotification()	Input row notification function.
p_<proc_name>_dataBdryNotification()	Data boundary notification function.
p_<proc_name>_eofNotification()	End of file notification function.
p_<proc_name>_partitionDeinit()	Partition deinitialization function.
p_<proc_name>_procedureDeinit()	Procedure deinitialization function.
m_<module_name>_moduleDeinit()	Module deinitialization function.

The following table lists the Custom transformation API functions:

Function	Description
INFA_CTSetDataAccessMode()	Set data access mode function.
INFA_CTGetAncestorHandle()	Get ancestor handle function.
INFA_CTGetChildrenHandles()	Get children handles function.
INFA_CTGetInputPortHandle()	Get input port handle function.
INFA_CTGetOutputPortHandle()	Get output port handle function.
INFA_CTGetInternalProperty<datatype>()	Get internal property function.
INFA_CTGetAllPropertyNamesM()	Get all property names in MBCS mode function.
INFA_CTGetAllPropertyNamesU()	Get all property names in Unicode mode function.
INFA_CTGetExternalProperty<datatype>M()	Get external property in MBCS function.
INFA_CTGetExternalProperty<datatype>U()	Get external property in Unicode function.
INFA_CTRebindInputDataType()	Rebind input port datatype function.
INFA_CTRebindOutputDataType()	Rebind output port datatype function.
INFA_CTGetData<datatype>()	Get data functions.
INFA_CTSetData()	Set data functions.
INFA_CTGetIndicator()	Get indicator function.

Function	Description
INFA_CTSetIndicator()	Set indicator function.
INFA_CTGetLength()	Get length function.
INFA_CTSetLength()	Set length function.
INFA_CTSetPassThruPort()	Set pass-through port function.
INFA_CTOutputNotification()	Output notification function.
INFA_CTDataBdryOutputNotification()	Data boundary output notification function.
INFA_CTGetErrorMsgU()	Get error message in Unicode function.
INFA_CTGetErrorMsgM()	Get error message in MBCS function.
INFA_CTLogMessageU()	Log message in the session log in Unicode function.
INFA_CTLogMessageM()	Log message in the session log in MBCS function.
INFA_CTIncrementErrorCount()	Increment error count function.
INFA_CTIsterminateRequested()	Is terminate requested function.
INFA_CTBlockInputFlow()	Block input groups function.
INFA_CTUnblockInputFlow()	Unblock input groups function.
INFA_CTSetUserDefinedPtr()	Set user-defined pointer function.
INFA_CTGetUserDefinedPtr()	Get user-defined pointer function.
INFA_CTChangeStringMode()	Change the string mode function.
INFA_CTSetDataCodePageID()	Set the data code page ID function.
INFA_CTGetRowStrategy()	Get row strategy function.
INFA_CTSetRowStrategy()	Set the row strategy function.
INFA_CTChangeDefaultRowStrategy()	Change the default row strategy of a transformation.

The following table lists the Custom transformation array-based functions:

Function	Description
INFA_CTAGetInputRowMax()	Get maximum number of input rows function.
INFA_CTAGetOutputRowMax()	Get maximum number of output rows function.
INFA_CTASetOutputRowMax()	Set maximum number of output rows function.

Function	Description
INFA_CTAGetNumRows()	Get number of rows function.
INFA_CTASetNumRows()	Set number of rows function.
INFA_CTAIsRowValid()	Is row valid function.
INFA_CTAGetData<datatype>()	Get data functions.
INFA_CTAGetIndicator()	Get indicator function.
INFA_CTASetData()	Set data function.
INFA_CTAGetRowStrategy()	Get row strategy function.
INFA_CTASetRowStrategy()	Set row strategy function.
INFA_CTASetInputErrorRowM()	Set input error row function for MBCS.
INFA_CTASetInputErrorRowU()	Set input error row function for Unicode.

Working with Rows

The Integration Service can pass a single row to a Custom transformation procedure or a block of rows in an array. You can write the procedure code to specify whether the procedure receives one row or a block of rows. You can increase performance when the procedure receives a block of rows:

- You can decrease the number of function calls the Integration Service and procedure make. The Integration Service calls the input row notification function fewer times, and the procedure calls the output notification function fewer times.
- You can increase the locality of memory access space for the data.
- You can write the procedure code to perform an algorithm on a block of data instead of each row of data.

By default, the procedure receives a row of data at a time. To receive a block of rows, you must include the `INFA_CTSetDataAccessMode()` function to change the data access mode to array-based. When the data access mode is array-based, you must use the array-based data handling and row strategy functions to access and output the data. When the data access mode is row-based, you must use the row-based data handling and row strategy functions to access and output the data.

All array-based functions use the prefix `INFA_CTA`. All other functions use the prefix `INFA_CT`.

Use the following steps to write the procedure code to access a block of rows:

1. Call `INFA_CTSetDataAccessMode()` during the procedure initialization, to change the data access mode to array-based.
2. When you create a passive Custom transformation, you can also call `INFA_CTSetPassThruPort()` during procedure initialization to pass through the data for input/output ports.

When a block of data reaches the Custom transformation procedure, the Integration Service calls `p_<proc_name>_inputRowNotification()` for each block of data. Perform the rest of the steps inside this function.

3. Call `INFA_CTAGetNumRows()` using the input group handle in the input row notification function to find the number of rows in the current block.
4. Call one of the `INFA_CTAGetData<datatype>()` functions using the input port handle to get the data for a particular row in the block.
5. Call `INFA_CTASetData` to output rows in a block.
6. Before calling `INFA_CTOutputNotification()`, call `INFA_CTASetNumRows()` to notify the Integration Service of the number of rows the procedure is outputting in the block.
7. Call `INFA_CTOutputNotification()`.

Rules and Guidelines for Row-Based and Array-Based Data Access Mode

Use the following rules and guidelines when you write the procedure code to use either row-based or array-based data access mode:

- In row-based mode, you can return `INFA_ROWERROR` in the input row notification function to indicate the function encountered an error for the row of data on input. The Integration Service increments the internal error count.
- In array-based mode, do not return `INFA_ROWERROR` in the input row notification function. The Integration Service treats that as a fatal error. If you need to indicate a row in a block has an error, call the `INFA_CTASetInputErrorRowM()` or `INFA_CTASetInputErrorRowU()` function.
- In row-based mode, the Integration Service only passes valid rows to the procedure.
- In array-based mode, an input block may contain invalid rows, such as dropped, filtered, or error rows. Call `INFA_CTAIsRowValid()` to determine if a row in a block is valid.
- In array-based mode, do not call `INFA_CTASetNumRows()` for a passive Custom transformation. You can call this function for active Custom transformations.
- In array-based mode, call `INFA_CTOutputNotification()` once.
- In array-based mode, you can call `INFA_CTSetPassThruPort()` only for passive Custom transformations.
- In array-based mode for passive Custom transformations, you must output all rows in an output block, including any error row.

Generated Functions

When you use the Designer to generate the procedure code, the Designer includes a set of functions called generated functions in the `m_<module_name>.c` and `p_<procedure_name>.c` files. The Integration Service uses the generated functions to interface with the procedure. When you run a session, the Integration Service calls these generated functions in the following order for each target load order group in the mapping:

1. Initialization functions
2. Notification functions
3. Deinitialization functions

Initialization Functions

The Integration Service first calls the initialization functions. Use the initialization functions to write processes you want the Integration Service to run before it passes data to the Custom transformation. Writing code in the initialization functions reduces processing overhead because the Integration Service runs these processes only once for a module, procedure, or partition.

The Designer generates the following initialization functions:

- m_<module_name>_moduleInit()
- p_<proc_name>_procInit()
- p_<proc_name>_partitionInit()

Module Initialization Function

The Integration Service calls the m_<module_name>_moduleInit() function during session initialization, before it runs the pre-session tasks. It calls this function, once for a module, before all other functions.

If you want the Integration Service to run a specific process when it loads the module, you must include it in this function. For example, you might write code to create global structures that procedures within this module access.

Use the following syntax:

```
INFA_STATUS m_<module_name>_moduleInit(INFA_CT_MODULE_HANDLE module);
```

The following table describes the arguments for this function:

Argument	Datatype	Input/Output	Description
module	INFA_CT_MODULE_HANDLE	Input	Module handle.

The return value datatype is INFA_STATUS. Use INFA_SUCCESS and INFA_FAILURE for the return value. When the function returns INFA_FAILURE, the Integration Service fails the session.

Procedure Initialization Function

The Integration Service calls p_<proc_name>_procInit() function during session initialization, before it runs the pre-session tasks and after it runs the module initialization function. The Integration Service calls this function once for each procedure in the module.

Write code in this function when you want the Integration Service to run a process for a particular procedure. You can also enter some API functions in the procedure initialization function, such as navigation and property functions.

Use the following syntax:

```
INFA_STATUS p_<proc_name>_procInit(INFA_CT_PROCEDURE_HANDLE procedure);
```

The following table describes the arguments for this function:

Argument	Datatype	Input/Output	Description
procedure	INFA_CT_PROCEDURE_HANDLE	Input	Procedure handle.

The return value datatype is INFA_STATUS. Use INFA_SUCCESS and INFA_FAILURE for the return value. When the function returns INFA_FAILURE, the Integration Service fails the session.

Partition Initialization Function

The Integration Service calls p_<proc_name>_partitionInit() function before it passes data to the Custom transformation. The Integration Service calls this function once for each partition at a Custom transformation instance.

If you want the Integration Service to run a specific process before it passes data through a partition of the Custom transformation, you must include it in this function.

Use the following syntax:

```
INFA_STATUS p_<proc_name>_partitionInit(INFA_CT_PARTITION_HANDLE transformation);
```

The following table describes the arguments for this function:

Argument	Datatype	Input/Output	Description
transformation	INFA_CT_PARTITION_HANDLE	Input	Partition handle.

The return value datatype is INFA_STATUS. Use INFA_SUCCESS and INFA_FAILURE for the return value. When the function returns INFA_FAILURE, the Integration Service fails the session.

Note: When the Custom transformation requires one thread for each partition, you can include thread-specific operations in the partition initialization function.

Notification Functions

The Integration Service calls the notification functions when it passes a row of data to the Custom transformation.

The Designer generates the following notification functions:

- p_<proc_name>_inputRowNotification()
- p_<proc_name>_dataBdryRowNotification()
- p_<proc_name>_eofNotification()

Note: When the Custom transformation requires one thread for each partition, you can include thread-specific operations in the notification functions.

Input Row Notification Function

The Integration Service calls the p_<proc_name>_inputRowNotification() function when it passes a row or a block of rows to the Custom transformation. It notes which input group and partition receives data through the input group handle and partition handle.

Use the following syntax:

```
INFA_ROWSTATUS p_<proc_name>_inputRowNotification(INFA_CT_PARTITION_HANDLE Partition, INFA_CT_INPUTGROUP_HANDLE group);
```

The following table describes the arguments for this function:

Argument	Datatype	Input/Output	Description
partition	INFA_CT_PARTITION_HANDLE	Input	Partition handle.
group	INFA_CT_INPUTGROUP_HANDLE	Input	Input group handle.

The datatype of the return value is INFA_ROWSTATUS. Use the following values for the return value:

- **INFA_ROWSUCCESS.** Indicates the function successfully processed the row of data.
- **INFA_ROWERROR.** Indicates the function encountered an error for the row of data. The Integration Service increments the internal error count. Only return this value when the data access mode is row.
If the input row notification function returns INFA_ROWERROR in array-based mode, the Integration Service treats it as a fatal error. If you need to indicate a row in a block has an error, call the INFA_CTASetInputErrorRowM() or INFA_CTASetInputErrorRowU() function.
- **INFA_FATALERROR.** Indicates the function encountered a fatal error for the row of data or the block of data. The Integration Service fails the session.

Data Boundary Notification Function

The Integration Service calls the p_<proc_name>_dataBdryNotification() function when it passes a commit or rollback row to a partition.

Use the following syntax:

```
INFA_STATUS p_<proc_name>_dataBdryNotification(INFA_CT_PARTITION_HANDLE transformation,
INFA_CTDataBdryType dataBoundaryType);
```

The following table describes the arguments for this function:

Argument	Datatype	Input/Output	Description
transformation	INFA_CT_PARTITION_HANDLE	Input	Partition handle.
dataBoundaryType	INFA_CTDataBdryType	Input	Integration Service uses one of the following values for the dataBoundaryType parameter: - eBT_COMMIT - eBT_ROLLBACK

The return value datatype is INFA_STATUS. Use INFA_SUCCESS and INFA_FAILURE for the return value. When the function returns INFA_FAILURE, the Integration Service fails the session.

End Of File Notification Function

The Integration Service calls the p_<proc_name>_eofNotification() function after it passes the last row to a partition in an input group.

Use the following syntax:

```
INFA_STATUS p_<proc_name>_eofNotification(INFA_CT_PARTITION_HANDLE transformation,
INFA_CT_INPUTGROUP_HANDLE group);
```

The following table describes the arguments for this function:

Argument	Datatype	Input/Output	Description
transformation	INFA_CT_PARTITION_HANDLE	Input	Partition handle.
group	INFA_CT_INPUTGROUP_HANDLE	Input	Input group handle.

The return value datatype is INFA_STATUS. Use INFA_SUCCESS and INFA_FAILURE for the return value. When the function returns INFA_FAILURE, the Integration Service fails the session.

Deinitialization Functions

The Integration Service calls the deinitialization functions after it processes data for the Custom transformation. Use the deinitialization functions to write processes you want the Integration Service to run after it passes all rows of data to the Custom transformation.

The Designer generates the following deinitialization functions:

- p_<proc_name>_partitionDeinit()
- p_<proc_name>_procDeinit()
- m_<module_name>_moduleDeinit()

Note: When the Custom transformation requires one thread for each partition, you can include thread-specific operations in the initialization and deinitialization functions.

Partition Deinitialization Function

The Integration Service calls the p_<proc_name>_partitionDeinit() function after it calls the p_<proc_name>_eofNotification() or p_<proc_name>_abortNotification() function. The Integration Service calls this function once for each partition of the Custom transformation.

Use the following syntax:

```
INFA_STATUS p_<proc_name>_partitionDeinit(INFA_CT_PARTITION_HANDLE partition);
```

The following table describes the arguments for this function:

Argument	Datatype	Input/Output	Description
partition	INFA_CT_PARTITION_HANDLE	Input	Partition handle.

The return value datatype is INFA_STATUS. Use INFA_SUCCESS and INFA_FAILURE for the return value. When the function returns INFA_FAILURE, the Integration Service fails the session.

Note: When the Custom transformation requires one thread for each partition, you can include thread-specific operations in the partition deinitialization function.

Procedure Deinitialization Function

The Integration Service calls the p_<proc_name>_procDeinit() function after it calls the p_<proc_name>_partitionDeinit() function for all partitions of each Custom transformation instance that uses this procedure in the mapping.

Use the following syntax:

```
INFA_STATUS p_<proc_name>_procDeinit(INFA_CT_PROCEDURE_HANDLE procedure, INFA_STATUS sessionStatus);
```

The following table describes the arguments for this function:

Argument	Datatype	Input/Output	Description
procedure	INFA_CT_PROCEDURE_HANDLE	Input	Procedure handle.
sessionStatus	INFA_STATUS	Input	Integration Service uses one of the following values for the sessionStatus parameter: <ul style="list-style-type: none">- INFA_SUCCESS. Indicates the session succeeded.- INFA_FAILURE. Indicates the session failed.

The return value datatype is INFA_STATUS. Use INFA_SUCCESS and INFA_FAILURE for the return value. When the function returns INFA_FAILURE, the Integration Service fails the session.

Module Deinitialization Function

The Integration Service calls the m_<module_name>_moduleDeinit() function after it runs the post-session tasks. It calls this function, once for a module, after all other functions.

Use the following syntax:

```
INFA_STATUS m_<module_name>_moduleDeinit(INFA_CT_MODULE_HANDLE module, INFA_STATUS sessionStatus);
```

The following table describes the arguments for this function:

Argument	Datatype	Input/Output	Description
module	INFA_CT_MODULE_HANDLE	Input	Module handle.
sessionStatus	INFA_STATUS	Input	Integration Service uses one of the following values for the sessionStatus parameter: <ul style="list-style-type: none">- INFA_SUCCESS. Indicates the session succeeded.- INFA_FAILURE. Indicates the session failed.

The return value datatype is INFA_STATUS. Use INFA_SUCCESS and INFA_FAILURE for the return value. When the function returns INFA_FAILURE, the Integration Service fails the session.

API Functions

PowerCenter provides a set of API functions that you use to develop the transformation logic. When the Designer generates the source code files, it includes the generated functions in the source code. Add API functions to the code to implement the transformation logic. The procedure uses the API functions to

interface with the Integration Service. You must code API functions in the procedure C file. Optionally, you can also code the module C file.

Informatica provides the following groups of API functions:

- Set data access mode
- Navigation
- Property
- Rebind datatype
- Data handling (row-based mode)
- Set pass-through port
- Output notification
- Data boundary output notification
- Error
- Session log message
- Increment error count
- Is terminated
- Blocking
- Pointer
- Change string mode
- Set data code page
- Row strategy (row-based mode)
- Change default row strategy

Informatica also provides array-based API Functions.

Set Data Access Mode Function

By default, the Integration Service passes data to the Custom transformation procedure one row at a time. However, use the `INFA_CTSetDataAccessMode()` function to change the data access mode to array-based. When you set the data access mode to array-based, the Integration Service passes multiple rows to the procedure as a block in an array.

When you set the data access mode to array-based, you must use the array-based versions of the data handling functions and row strategy functions. When you use a row-based data handling or row strategy function and you switch to array-based mode, you will get unexpected results. For example, the DLL or shared library might crash.

You can only use this function in the procedure initialization function.

If you do not use this function in the procedure code, the data access mode is row-based. However, when you want the data access mode to be row-based, include this function and set the access mode to row-based.

Use the following syntax:

```
INFA_STATUS INFA_CTSetDataAccessMode( INFA_CT_PROCEDURE_HANDLE procedure,  
INFA_CT_DATA_ACCESS_MODE mode );
```

The following table describes the arguments for this function:

Argument	Datatype	Input/Output	Description
procedure	INFA_CT_PROCEDURE_HANDLE	Input	Procedure name.
mode	INFA_CT_DATA_ACCESS_MODE	Input	Data access mode. Use the following values for the mode parameter: - eDA_ROW - eDA_ARRAY

Navigation Functions

Use the navigation functions when you want the procedure to navigate through the handle hierarchy.

PowerCenter provides the following navigation functions:

- INFA_CTGetAncestorHandle()
- INFA_CTGetChildrenHandles()
- INFA_CTGetInputPortHandle()
- INFA_CTGetOutputPortHandle()

Get Ancestor Handle Function

Use the INFA_CTGetAncestorHandle() function when you want the procedure to access a parent handle of a given handle.

Use the following syntax:

```
INFA_CT_HANDLE INFA_CTGetAncestorHandle(INFA_CT_HANDLE handle, INFA_CTHandleType returnHandleType);
```

The following table describes the arguments for this function:

Argument	Datatype	Input/Output	Description
handle	INFA_CT_HANDLE	Input	Handle name.
returnHandleType	INFA_CTHandleType	Input	Return handle type. Use the following values for the returnHandleType parameter: - PROCEDURETYPE - TRANSFORMATIONTYPE - PARTITIONTYPE - INPUTGROUPTYPE - OUTPUTGROUPTYPE - INPUTPORTTYPE - OUTPUTPORTTYPE

The handle parameter specifies the handle whose parent you want the procedure to access. The Integration Service returns INFA_CT_HANDLE if you specify a valid handle in the function. Otherwise, it returns a null value.

To avoid compilation errors, you must code the procedure to set a handle name to the return value.

For example, you can enter the following code:

```
INFA_CT_MODULE_HANDLE module = INFA_CTGetAncestorHandle(procedureHandle,
INFA_CT_HandleType);
```

Get Children Handles Function

Use the INFA_CTGetChildrenHandles() function when you want the procedure to access the children handles of a given handle.

Use the following syntax:

```
INFA_CT_HANDLE* INFA_CTGetChildrenHandles(INFA_CT_HANDLE handle, size_t*
pnChildrenHandles, INFA_CTHandleType returnHandleType);
```

The following table describes the arguments for this function:

Argument	Datatype	Input/ Output	Description
handle	INFA_CT_HANDLE	Input	Handle name.
pnChildrenHandles	size_t*	Output	Integration Service returns an array of children handles. The pnChildrenHandles parameter indicates the number of children handles in the array.
returnHandleType	INFA_CTHandleType	Input	Use the following values for the returnHandleType parameter: <ul style="list-style-type: none"> - PROCEDURETYPE - TRANSFORMATIONTYPE - PARTITIONTYPE - INPUTGROUPTYPE - OUTPUTGROUPTYPE - INPUTPORTTYPE - OUTPUTPORTTYPE

The handle parameter specifies the handle whose children you want the procedure to access. The Integration Service returns INFA_CT_HANDLE* when you specify a valid handle in the function. Otherwise, it returns a null value.

To avoid compilation errors, you must code the procedure to set a handle name to the returned value.

For example, you can enter the following code:

```
INFA_CT_PARTITION_HANDLE partition = INFA_CTGetChildrenHandles(procedureHandle,
pnChildrenHandles, INFA_CT_PARTITION_HANDLE_TYPE);
```

Get Port Handle Functions

The Integration Service associates the INFA_CT_INPUTPORT_HANDLE with input and input/output ports, and the INFA_CT_OUTPUTPORT_HANDLE with output and input/output ports.

PowerCenter provides the following get port handle functions:

- **INFA_CTGetInputPortHandle()**. Use this function when the procedure knows the output port handle for an input/output port and needs the input port handle.

Use the following syntax:

```
INFA_CTINFA_CT_INPUTPORT_HANDLE INFA_CTGetInputPortHandle(INFA_CT_OUTPUTPORT_HANDLE  
outputPortHandle);
```

The following table describes the argument for this function:

Argument	Datatype	Input/ Output	Description
outputPortHandle	INFA_CT_OUTPUTPORT_HANDLE	input	Output port handle.

- **INFA_CTGetOutputPortHandle()**. Use this function when the procedure knows the input port handle for an input/output port and needs the output port handle.

Use the following syntax:

```
INFA_CT_OUTPUTPORT_HANDLE INFA_CTGetOutputPortHandle(INFA_CT_INPUTPORT_HANDLE  
inputPortHandle);
```

The following table describes the argument for this function:

Argument	Datatype	Input/ Output	Description
inputPortHandle	INFA_CT_INPUTPORT_HANDLE	input	Input port handle.

The Integration Service returns NULL when you use the get port handle functions with input or output ports.

Property Functions

Use the property functions when you want the procedure to access the Custom transformation properties. The property functions access properties on the following tabs of the Custom transformation:

- Ports
- Properties
- Initialization Properties
- Metadata Extensions
- Port Attribute Definitions

Use the following property functions in initialization functions:

- INFA_CTGetInternalProperty<datatype>()
- INFA_CTGetAllPropertyNamesM()
- INFA_CTGetAllPropertyNamesU()
- INFA_CTGetExternalProperty<datatype>M()
- INFA_CTGetExternalProperty<datatype>U()

Get Internal Property Function

PowerCenter provides functions to access the port attributes specified on the ports tab, and properties specified for attributes on the Properties tab of the Custom transformation.

The Integration Service associates each port and property attribute with a property ID. You must specify the property ID in the procedure to access the values specified for the attributes. For the handle parameter, specify a handle name from the handle hierarchy. The Integration Service fails the session if the handle name is invalid.

Use the following functions when you want the procedure to access the properties:

- **INFA_CTGetInternalPropertyStringM()**. Accesses a value of type string in MBCS for a given property ID.

Use the following syntax:

```
INFA_STATUS INFA_CTGetInternalPropertyStringM( INFA_CT_HANDLE handle, size_t propId,
const char** psPropValue );
```

- **INFA_CTGetInternalPropertyStringU()**. Accesses a value of type string in Unicode for a given property ID.

Use the following syntax:

```
INFA_STATUS INFA_CTGetInternalPropertyStringU( INFA_CT_HANDLE handle, size_t propId,
const INFA_UNICHAR** psPropValue );
```

- **INFA_CTGetInternalPropertyInt32()**. Accesses a value of type integer for a given property ID.

Use the following syntax:

```
INFA_STATUS INFA_CTGetInternalPropertyInt32( INFA_CT_HANDLE handle, size_t propId,
INFA_INT32* pnPropValue );
```

- **INFA_CTGetInternalPropertyBool()**. Accesses a value of type Boolean for a given property ID.

Use the following syntax:

```
INFA_STATUS INFA_CTGetInternalPropertyBool( INFA_CT_HANDLE handle, size_t propId,
INFA_BOOLEAN* pbPropValue );
```

- **INFA_CTGetInternalPropertyINFA_PTR()**. Accesses a pointer to a value for a given property ID.

Use the following syntax:

```
INFA_STATUS INFA_CTGetInternalPropertyINFA_PTR( INFA_CT_HANDLE handle, size_t propId,
INFA_PTR* pvPropValue );
```

The return value datatype is INFA_STATUS. Use INFA_SUCCESS and INFA_FAILURE for the return value.

Port and Property Attribute Property IDs

The following tables list the property IDs for the port and property attributes in the Custom transformation. Each table lists a Custom transformation handle and the property IDs you can access with the handle in a property function.

The following table lists INFA_CT_MODULE_HANDLE property IDs:

Handle Property ID	Datatype	Description
INFA_CT_MODULE_NAME	String	Specifies the module name.
INFA_CT_SESSION_INFA_VERSION	String	Specifies the Informatica version.
INFA_CT_SESSION_CODE_PAGE	Integer	Specifies the Integration Service code page.

Handle Property ID	Datatype	Description
INFA_CT_SESSION_DATAMOVEMENT_MODE	Integer	Specifies the data movement mode. The Integration Service returns one of the following values: - eASM_MBCS - eASM_UNICODE
INFA_CT_SESSION_VALIDATE_CODEPAGE	Boolean	Specifies whether the Integration Service enforces code page validation.
INFA_CT_SESSION_PROD_INSTALL_DIR	String	Specifies the Integration Service installation directory.
INFA_CT_SESSION_HIGH_PRECISION_MODE	Boolean	Specifies whether session is configured for high precision.
INFA_CT_MODULE_RUNTIME_DIR	String	Specifies the runtime directory for the DLL or shared library.
INFA_CT_SESSION_IS_UPD_STR_ALLOWED	Boolean	Specifies whether the Update Strategy Transformation property is selected in the transformation.
INFA_CT_TRANS_OUTPUT_IS_REPEATABLE	Integer	Specifies whether the Custom transformation produces data in the same order in every session run. The Integration Service returns one of the following values: - eOUTREPEAT_NEVER = 1 - eOUTREPEAT_ALWAYS = 2 - eOUTREPEAT_BASED_ON_INPUT_ORDER = 3
INFA_CT_TRANS_FATAL_ERROR	Boolean	Specifies if the Custom Transformation caused a fatal error. The Integration Service returns one of the following values: - INFA_TRUE - INFA_FALSE

The following table lists INFA_CT_PROC_HANDLE property IDs:

Handle Property ID	Datatype	Description
INFA_CT_PROCEDURE_NAME	String	Specifies the Custom transformation procedure name.

The following table lists INFA_CT_TRANS_HANDLE property IDs:

Handle Property ID	Datatype	Description
INFA_CT_TRANS_INSTANCE_NAME	String	Specifies the Custom transformation instance name.
INFA_CT_TRANS_TRACE_LEVEL	Integer	Specifies the tracing level. The Integration Service returns one of the following values: <ul style="list-style-type: none"> - eTRACE_TERSE - eTRACE_NORMAL - eTRACE_VERBOSE_INIT - eTRACE_VERBOSE_DATA
INFA_CT_TRANS_MAY_BLOCK_DATA	Boolean	Specifies if the Integration Service allows the procedure to block input data in the current session.
INFA_CT_TRANS_MUST_BLOCK_DATA	Boolean	Specifies if the Inputs Must Block Custom transformation property is selected.
INFA_CT_TRANS_ISACTIVE	Boolean	Specifies whether the Custom transformation is an active or passive transformation.
INFA_CT_TRANS_ISPARTITIONABLE	Boolean	Specifies if you can partition sessions that use this Custom transformation.
INFA_CT_TRANS_IS_UPDATE_STRATEGY	Boolean	Specifies if the Custom transformation behaves like an Update Strategy transformation.
INFA_CT_TRANS_DEFAULT_UPDATE_STRATEGY	Integer	Specifies the default update strategy. <ul style="list-style-type: none"> - eDUS_INSERT - eDUS_UPDATE - eDUS_DELETE - eDUS_REJECT - eDUS_PASSTHROUGH
INFA_CT_TRANS_NUM_PARTITIONS	Integer	Specifies the number of partitions in the sessions that use this Custom transformation.
INFA_CT_TRANS_DATACODEPAGE	Integer	Specifies the code page in which the Integration Service passes data to the Custom transformation. Use the set data code page function if you want the Custom transformation to access data in a different code page.
INFA_CT_TRANS_TRANSFORM_SCOPE	Integer	Specifies the transformation scope in the Custom transformation. The Integration Service returns one of the following values: <ul style="list-style-type: none"> - eTS_ROW - eTS_TRANSACTION - eTS_ALLINPUT
INFA_CT_TRANS_GENERATE_TRANSACTION	Boolean	Specifies if the Generate Transaction property is enabled. The Integration Service returns one of the following values: <ul style="list-style-type: none"> - INFA_TRUE - INFA_FALSE

Handle Property ID	Datatype	Description
INFA_CT_TRANS_OUTPUT_IS_REPEATABLE	Integer	Specifies whether the Custom transformation produces data in the same order in every session run. The Integration Service returns one of the following values: <ul style="list-style-type: none"> - eOUTREPEAT_NEVER = 1 - eOUTREPEAT_ALWAYS = 2 - eOUTREPEAT_BASED_ON_INPUT_ORDER = 3
INFA_CT_TRANS_FATAL_ERROR	Boolean	Specifies if the Custom Transformation caused a fatal error. The Integration Service returns one of the following values: <ul style="list-style-type: none"> - INFA_TRUE - INFA_FALSE

The following table lists INFA_CT_INPUT_GROUP_HANDLE and INFA_CT_OUTPUT_GROUP_HANDLE property IDs:

Handle Property ID	Datatype	Description
INFA_CT_GROUP_NAME	String	Specifies the group name.
INFA_CT_GROUP_NUM_PORTS	Integer	Specifies the number of ports in the group.
INFA_CT_GROUP_ISCONNECTED	Boolean	Specifies if all ports in a group are connected to another transformation.
INFA_CT_PORT_NAME	String	Specifies the port name.
INFA_CT_PORT_CDATATYPE	Integer	Specifies the port datatype. The Integration Service returns one of the following values: <ul style="list-style-type: none"> - eINFA_CTYPE_SHORT - eINFA_CTYPE_INT32 - eINFA_CTYPE_CHAR - eINFA_CTYPE_RAW - eINFA_CTYPE_UNICHAR - eINFA_CTYPE_TIME - eINFA_CTYPE_FLOAT - eINFA_CTYPE_DOUBLE - eINFA_CTYPE_DECIMAL18_FIXED - eINFA_CTYPE_DECIMAL28_FIXED - eINFA_CTYPE_INFA_CTDATETIME
INFA_CT_PORT_PRECISION	Integer	Specifies the port precision.
INFA_CT_PORT_SCALE	Integer	Specifies the port scale (if applicable).
INFA_CT_PORT_IS_MAPPED	Boolean	Specifies whether the port is linked to other transformations in the mapping.

Handle Property ID	Datatype	Description
INFA_CT_PORT_STORAGESIZE	Integer	Specifies the internal storage size of the data for a port. The storage size depends on the datatype of the port.
INFA_CT_PORT_BOUNDDATATYPE	Integer	Specifies the port datatype. Use instead of INFA_CT_PORT_CDATATYPE if you rebind the port and specify a datatype other than the default.

The following table lists INFA_CT_INPUTPORT_HANDLE and INFA_CT_OUTPUT_HANDLE property IDs:

Handle Property ID	Datatype	Description
INFA_CT_PORT_NAME	String	Specifies the port name.
INFA_CT_PORT_CDATATYPE	Integer	Specifies the port datatype. The Integration Service returns one of the following values: <ul style="list-style-type: none"> - eINFA_CTYPE_SHORT - eINFA_CTYPE_INT32 - eINFA_CTYPE_CHAR - eINFA_CTYPE_RAW - eINFA_CTYPE_UNICHAR - eINFA_CTYPE_TIME - eINFA_CTYPE_FLOAT - eINFA_CTYPE_DOUBLE - eINFA_CTYPE_DECIMAL18_FIXED - eINFA_CTYPE_DECIMAL28_FIXED - eINFA_CTYPE_INFA_CTDATETIME
INFA_CT_PORT_PRECISION	Integer	Specifies the port precision.
INFA_CT_PORT_SCALE	Integer	Specifies the port scale, if applicable.
INFA_CT_PORT_IS_MAPPED	Boolean	Specifies whether the port is linked to other transformations in the mapping.
INFA_CT_PORT_STORAGESIZE	Integer	Specifies the internal storage size of the data for a port. The storage size depends on the datatype of the port.
INFA_CT_PORT_BOUNDDATATYPE	Integer	Specifies the port datatype. Use instead of INFA_CT_PORT_CDATATYPE if you rebind the port and specify a datatype other than the default.

Get All External Property Names (MBCS or Unicode)

PowerCenter provides two functions to access the property names defined on the Metadata Extensions tab, Initialization Properties tab, and Port Attribute Definitions tab of the Custom transformation.

Use the following functions when you want the procedure to access the property names:

- **INFA_CTGetAllPropertyNamesM()**. Accesses the property names in MBCS.

Use the following syntax:

```
INFA_STATUS INFA_CTGetAllPropertyNamesM(INFA_CT_HANDLE handle, const char*const**
paPropertyNames, size_t* pnProperties);
```

The following table describes the arguments for this function:

Argument	Datatype	Input/ Output	Description
handle	INFA_CT_HANDLE	Input	Specify the handle name.
paPropertyNames	const char*const**	Output	Specifies the property name. The Integration Service returns an array of property names in MBCS.
pnProperties	size_t*	Output	Indicates the number of properties in the array.

- **INFA_CTGetAllPropertyNamesU()**. Accesses the property names in Unicode.

Use the following syntax:

```
INFA_STATUS INFA_CTGetAllPropertyNamesU(INFA_CT_HANDLE handle, const
INFA_UNICHAR*const** pasPropertyNames, size_t* pnProperties);
```

The following table describes the arguments for this function:

Argument	Datatype	Input/ Output	Description
handle	INFA_CT_HANDLE	Input	Specify the handle name.
paPropertyNames	const INFA_UNICHAR*const**	Output	Specifies the property name. The Integration Service returns an array of property names in Unicode.
pnProperties	size_t*	Output	Indicates the number of properties in the array.

The return value datatype is INFA_STATUS. Use INFA_SUCCESS and INFA_FAILURE for the return value.

Get External Properties (MBCS or Unicode)

PowerCenter provides functions to access the values of the properties defined on the Metadata Extensions tab, Initialization Properties tab, or Port Attribute Definitions tab of the Custom transformation.

You must specify the property names in the functions if you want the procedure to access the values. Use the INFA_CTGetAllPropertyNamesM() or INFA_CTGetAllPropertyNamesU() functions to access property names. For the handle parameter, specify a handle name from the handle hierarchy. The Integration Service fails the session if the handle name is invalid.

Note: If you define an initialization property with the same name as a metadata extension, the Integration Service returns the metadata extension value.

Use the following functions when you want the procedure to access the values of the properties:

- **INFA_CTGetExternalProperty<datatype>M()**. Accesses the value of the property in MBCS.

The following table shows the syntax:

Syntax	Property Datatype
<code>INFA_STATUS INFA_CTGetExternalPropertyStringM(INFA_CT_HANDLE handle, const char* sPropName, const char** psPropValue);</code>	String
<code>INFA_STATUS INFA_CTGetExternalPropertyINT32M(INFA_CT_HANDLE handle, const char* sPropName, INFA_INT32* pnPropValue);</code>	Integer
<code>INFA_STATUS INFA_CTGetExternalPropertyBoolM(INFA_CT_HANDLE handle, const char* sPropName, INFA_BOOLEAN* pbPropValue);</code>	Boolean

- **INFA_CTGetExternalProperty<datatype>U()**. Accesses the value of the property in Unicode.

The following table shows the syntax:

Syntax	Property Datatype
<code>INFA_STATUS INFA_CTGetExternalPropertyStringU(INFA_CT_HANDLE handle, INFA_UNICHAR* sPropName, INFA_UNICHAR** psPropValue);</code>	String
<code>INFA_STATUS INFA_CTGetExternalPropertyStringU(INFA_CT_HANDLE handle, INFA_UNICHAR* sPropName, INFA_INT32* pnPropValue);</code>	Integer
<code>INFA_STATUS INFA_CTGetExternalPropertyStringU(INFA_CT_HANDLE handle, INFA_UNICHAR* sPropName, INFA_BOOLEAN* pbPropValue);</code>	Boolean

The return value datatype is INFA_STATUS. Use INFA_SUCCESS and INFA_FAILURE for the return value.

Rebind Datatype Functions

You can rebind a port with a datatype other than the default datatype with PowerCenter. Use the rebind datatype functions if you want the procedure to access data in a datatype other than the default datatype. You must rebind the port with a compatible datatype.

You can only use these functions in the initialization functions.

Consider the following rules when you rebind the datatype for an output or input/output port:

- You must use the data handling functions to set the data and the indicator for that port. Use the INFA_CTSetData() and INFA_CTSetIndicator() functions in row-based mode, and use the INFA_CTASetData() function in array-based mode.
- Do not call the INFA_CTSetPassThruPort() function for the output port.

The following table lists compatible datatypes:

Default Datatype	Compatible With
Char	Unichar
Unichar	Char
Date	INFA_DATETIME Use the following syntax: <pre>struct INFA_DATETIME { int nYear; int nMonth; int nDay; int nHour; int nMinute; int nSecond; int nNanoSecond; }</pre>
Dec18	Char, Unichar
Dec28	Char, Unichar

PowerCenter provides the following rebind datatype functions:

- **INFA_CTRebindInputDataType()**. Rebinds the input port. Use the following syntax:

```
INFA_STATUS INFA_CTRebindInputDataType(INFA_CT_INPUTPORT_HANDLE portHandle,
INFA_CDATATYPE datatype);
```

- **INFA_CTRebindOutputDataType()**. Rebinds the output port. Use the following syntax:

```
INFA_STATUS INFA_CTRebindOutputDataType(INFA_CT_OUTPUTPORT_HANDLE portHandle,
INFA_CDATATYPE datatype);
```

The following table describes the arguments for this function:

Argument	Datatype	Input/ Output	Description
portHandle	INFA_CT_OUTPUTPORT_HANDLE	Input	Output port handle.
datatype	INFA_CDATATYPE	Input	The datatype with which you rebind the port. Use the following values for the datatype parameter: <ul style="list-style-type: none"> - eINFA_CTYPE_SHORT - eINFA_CTYPE_INT32 - eINFA_CTYPE_CHAR - eINFA_CTYPE_RAW - eINFA_CTYPE_UNICHAR - eINFA_CTYPE_TIME - eINFA_CTYPE_FLOAT - eINFA_CTYPE_DOUBLE - eINFA_CTYPE_DECIMAL18_FIXED - eINFA_CTYPE_DECIMAL28_FIXED - eINFA_CTYPE_INFA_CTDATETIME

The return value datatype is INFA_STATUS. Use INFA_SUCCESS and INFA_FAILURE for the return value.

Data Handling Functions (Row-Based Mode)

When the Integration Service calls the input row notification function, it notifies the procedure that the procedure can access a row or block of data. However, to get data from the input port, modify it, and set data in the output port, you must use the data handling functions in the input row notification function. When the data access mode is row-based, use the row-based data handling functions.

Include the INFA_CTGetData<datatype>() function to get the data from the input port and INFA_CTSetData() function to set the data in the output port. Include the INFA_CTGetIndicator() or INFA_CTGetLength() function if you want the procedure to verify before you get the data if the port has a null value or an empty string.

PowerCenter provides the following data handling functions:

- INFA_CTGetData<datatype>()
- INFA_CTSetData()
- INFA_CTGetIndicator()
- INFA_CTSetIndicator()
- INFA_CTGetLength()
- INFA_CTSetLength()

Get Data Functions (Row-Based Mode)

Use the INFA_CTGetData<datatype>() functions to retrieve data for the port the function specifies.

You must modify the function name depending on the datatype of the port you want the procedure to access.

The following table lists the INFA_CTGetData<datatype>() function syntax and the datatype of the return value:

Syntax	Return Value Datatype
<code>void* INFA_CTGetDataVoid(INFA_CT_INPUTPORT_HANDLE dataHandle);</code>	Data void pointer to the return value
<code>char* INFA_CTGetDataStringM(INFA_CT_INPUTPORT_HANDLE dataHandle);</code>	String (MBCS)
<code>IUNICHAR* INFA_CTGetDataStringU(INFA_CT_INPUTPORT_HANDLE dataHandle);</code>	String (Unicode)
<code>INFA_INT32 INFA_CTGetDataINT32(INFA_CT_INPUTPORT_HANDLE dataHandle);</code>	Integer
<code>double INFA_CTGetDataDouble(INFA_CT_INPUTPORT_HANDLE dataHandle);</code>	Double
<code>INFA_CT_RAWDATE INFA_CTGetDataDate(INFA_CT_INPUTPORT_HANDLE dataHandle);</code>	Raw date
<code>INFA_CT_RAWDEC18 INFA_CTGetDataRawDec18(INFA_CT_INPUTPORT_HANDLE dataHandle);</code>	Decimal BLOB (precision 18)
<code>INFA_CT_RAWDEC28 INFA_CTGetDataRawDec28(INFA_CT_INPUTPORT_HANDLE dataHandle);</code>	Decimal BLOB (precision 28)
<code>INFA_CT_DATETIME INFA_CTGetDataDateTime(INFA_CT_INPUTPORT_HANDLE dataHandle);</code>	Datetime

Set Data Function (Row-Based Mode)

Use the INFA_CTSetData() function when you want the procedure to pass a value to an output port.

Use the following syntax:

```
INFA_STATUS INFA_CTSetData(INFA_CT_OUTPUTPORT_HANDLE dataHandle, void* data);
```

The return value datatype is INFA_STATUS. Use INFA_SUCCESS and INFA_FAILURE for the return value.

Note: If you use the INFA_CTSetPassThruPort() function on an input/output port, do not use set the data or indicator for that port.

Indicator Functions (Row-Based Mode)

Use the indicator functions when you want the procedure to get the indicator for an input port or to set the indicator for an output port. The indicator for a port indicates whether the data is valid, null, or truncated.

PowerCenter provides the following indicator functions:

- **INFA_CTGetIndicator()**. Gets the indicator for an input port. Use the following syntax:

```
INFA_INDICATOR INFA_CTGetIndicator(INFA_CT_INPUTPORT_HANDLE dataHandle);
```

The return value datatype is INFA_INDICATOR. Use the following values for INFA_INDICATOR:

- **INFA_DATA_VALID**. Indicates the data is valid.
- **INFA_NULL_DATA**. Indicates a null value.

- **INFA_DATA_TRUNCATED**. Indicates the data has been truncated.

- **INFA_CTSetIndicator()**. Sets the indicator for an output port. Use the following syntax:

```
INFA_STATUS INFA_CTSetIndicator(INFA_CT_OUTPUTPORT_HANDLE dataHandle, INFA_INDICATOR indicator);
```

The following table describes the arguments for this function:

Argument	Datatype	Input/Output	Description
dataHandle	INFA_CT_OUTPUTPORT_HANDLE	Input	Output port handle.
indicator	INFA_INDICATOR	Input	The indicator value for the output port. Use one of the following values: <ul style="list-style-type: none">- INFA_DATA_VALID. Indicates the data is valid.- INFA_NULL_DATA. Indicates a null value.- INFA_DATA_TRUNCATED. Indicates the data has been truncated.

The return value datatype is **INFA_STATUS**. Use **INFA_SUCCESS** and **INFA_FAILURE** for the return value.

Note: If you use the **INFA_CTSetPassThruPort()** function on an input/output port, do not set the data or indicator for that port.

Length Functions

Use the length functions when you want the procedure to access the length of a string or binary input port, or to set the length of a binary or string output port.

Use the following length functions:

- **INFA_CTGetLength()**. Use this function for string and binary ports only. The Integration Service returns the length as the number of characters including trailing spaces. Use the following syntax:

```
INFA_UINT32 INFA_CTGetLength(INFA_CT_INPUTPORT_HANDLE dataHandle);
```

The return value datatype is **INFA_UINT32**. Use a value between zero and 2GB for the return value.

- **INFA_CTSetLength()**. When the Custom transformation contains a binary or string output port, you must use this function to set the length of the data, including trailing spaces. Verify you the length you set for string and binary ports is not greater than the precision for that port. If you set the length greater than the port precision, you get unexpected results. For example, the session may fail.

Use the following syntax:

```
INFA_STATUS INFA_CTSetLength(INFA_CT_OUTPUTPORT_HANDLE dataHandle, IUIN32 length);
```

The return value datatype is **INFA_STATUS**. Use **INFA_SUCCESS** and **INFA_FAILURE** for the return value.

Set Pass-Through Port Function

Use the **INFA_CTSetPassThruPort()** function when you want the Integration Service to pass data from an input port to an output port without modifying the data. When you use the **INFA_CTSetPassThruPort()** function, the Integration Service passes the data to the output port when it calls the input row notification function.

Consider the following rules and guidelines when you use the set pass-through port function:

- Only use this function in an initialization function.

- If the procedure includes this function, do not include the `INFA_CTSetData()`, `INFA_CTSetLength`, `INFA_CTSetIndicator()`, or `INFA_CTASetData()` functions to pass data to the output port.
- In row-based mode, you can only include this function when the transformation scope is Row. When the transformation scope is Transaction or All Input, this function returns `INFA_FAILURE`.
- In row-based mode, when you use this function to output multiple rows for a given input row, every output row contains the data that is passed through from the input port.
- In array-based mode, you can only use this function for passive Custom transformations.

You must verify that the datatype, precision, and scale are the same for the input and output ports. The Integration Service fails the session if the datatype, precision, or scale are not the same for the input and output ports you specify in the `INFA_CTSetPassThruPort()` function.

Use the following syntax:

```
INFA_STATUS INFA_CTSetPassThruPort(INFA_CT_OUTPUTPORT_HANDLE outputport,
INFA_CT_INPUTPORT_HANDLE inputport)
```

The return value datatype is `INFA_STATUS`. Use `INFA_SUCCESS` and `INFA_FAILURE` for the return value.

Output Notification Function

When you want the procedure to output a row to the Integration Service, use the `INFA_CTOutputNotification()` function. Only include this function for active Custom transformations. For passive Custom transformations, the procedure outputs a row to the Integration Service when the input row notification function gives a return value. If the procedure calls this function for a passive Custom transformation, the Integration Service ignores the function.

Note: When the transformation scope is Row, you can only include this function in the input row notification function. If you include it somewhere else, it returns a failure.

Use the following syntax:

```
INFA_ROWSTATUS INFA_CTOutputNotification(INFA_CT_OUTPUTGROUP_HANDLE group);
```

The following table describes the argument for this function:

Argument	Datatype	Input/ Output	Description
group	INFA_CT_OUTPUT_GROUP_HANDLE	Input	Output group handle.

The return value datatype is `INFA_ROWSTATUS`. Use the following values for the return value:

- **INFA_ROWSUCCESS.** Indicates the function successfully processed the row of data.
- **INFA_ROWERROR.** Indicates the function encountered an error for the row of data. The Integration Service increments the internal error count.
- **INFA_FATALERROR.** Indicates the function encountered a fatal error for the row of data. The Integration Service fails the session.

Note: When the procedure code calls the `INFA_CTOutputNotification()` function, you must verify that all pointers in an output port handle point to valid data. When a pointer does not point to valid data, the Integration Service might shut down unexpectedly.

Data Boundary Output Notification Function

Include the `INFA_CTDataBdryOutputNotification()` function when you want the procedure to output a commit or rollback transaction.

When you use this function, you must select the Generate Transaction property for this Custom transformation. If you do not select this property, the Integration Service fails the session.

Use the following syntax:

```
INFA_STATUS INFA_CTDataBdryOutputNotification(INFA_CT_PARTITION_HANDLE handle,
INFA_CTDataBdryType dataBoundaryType);
```

The following table describes the arguments for this function:

Argument	Datatype	Input/Output	Description
handle	INFA_CT_PARTITION_HANDLE	Input	Handle name.
dataBoundaryType	INFA_CTDataBdryType	Input	The transaction type. Use the following values for the dataBoundaryType parameter: - eBT_COMMIT - eBT_ROLLBACK

The return value datatype is `INFA_STATUS`. Use `INFA_SUCCESS` and `INFA_FAILURE` for the return value.

Error Functions

Use the error functions to access procedure errors. The Integration Service returns the most recent error.

PowerCenter provides the following error functions:

- **INFA_CTGetErrorMsgM()**. Gets the error message in MBCS. Use the following syntax:

```
const char* INFA_CTGetErrorMsgM();
```
- **INFA_CTGetErrorMsgU()**. Gets the error message in Unicode. Use the following syntax:

```
const IUNICHAR* INFA_CTGetErrorMsgU();
```

Session Log Message Functions

Use the session log message functions when you want the procedure to log a message in the session log in either Unicode or MBCS.

PowerCenter provides the following session log message functions:

- **INFA_CTLogMessageU()**. Logs a message in Unicode.

Use the following syntax:

```
void INFA_CTLogMessageU(INFA_CT_ErrorSeverityLevel errorseverityLevel, INFA_UNICHAR* msg)
```

The following table describes the arguments for this function:

Argument	Datatype	Input/Output	Description
errorSeverityLevel	INFA_CT_ErrorSeverityLevel	Input	Severity level of the error message that you want the Integration Service to write in the session log. Use the following values for the errorSeverityLevel parameter: - eESL_LOG - eESL_DEBUG - eESL_ERROR
msg	INFA_UNICHAR*	Input	Enter the text of the message in Unicode in quotes.

- **INFA_CTLogMessageM()**. Logs a message in MBCS.

Use the following syntax:

```
void INFA_CTLogMessageM(INFA_CT_ErrorSeverityLevel errorSeverityLevel, char* msg)
```

The following table describes the arguments for this function:

Argument	Datatype	Input/Output	Description
errorSeverityLevel	INFA_CT_ErrorSeverityLevel	Input	Severity level of the error message that you want the Integration Service to write in the session log. Use the following values for the errorSeverityLevel parameter: - eESL_LOG - eESL_DEBUG - eESL_ERROR
msg	char*	Input	Enter the text of the message in MBCS in quotes.

Increment Error Count Function

Use the INFA_CTIncrementErrorCount() function when you want to increase the error count for the session.

Use the following syntax:

```
INFA_STATUS INFA_CTIncrementErrorCount(INFA_CT_PARTITION_HANDLE transformation, size_t nErrors, INFA_STATUS* pStatus);
```

The following table describes the arguments for this function:

Argument	Datatype	Input/Output	Description
transformation	INFA_CT_PARTITION_HANDLE	Input	Partition handle.
nErrors	size_t	Input	Integration Service increments the error count by nErrors for the given transformation instance.
pStatus	INFA_STATUS*	Input	Integration Service uses INFA_FAILURE for the pStatus parameter when the error count exceeds the error threshold and fails the session.

The return value datatype is INFA_STATUS. Use INFA_SUCCESS and INFA_FAILURE for the return value.

Is Terminated Function

Use the INFA_CTIsTerminated() function when you want the procedure to check if the PowerCenter Client has requested the Integration Service to stop the session. You might call this function if the procedure includes a time-consuming process.

Use the following syntax:

```
INFA_CTTerminateType INFA_CTIsTerminated(INFA_CT_PARTITION_HANDLE handle);
```

The following table describes the argument for this function:

Argument	Datatype	Input/Output	Description
handle	INFA_CT_PARTITION_HANDLE	input	Partition handle.

The return value datatype is INFA_CTTerminateType. The Integration Service returns one of the following values:

- **eTT_NOTTERMINATED.** Indicates the PowerCenter Client has not requested to stop the session.
- **eTT_ABORTED.** Indicates the Integration Service aborted the session.
- **eTT_STOPPED.** Indicates the Integration Service failed the session.

Blocking Functions

When the Custom transformation contains multiple input groups, you can write code to block the incoming data on an input group.

Consider the following rules when you use the blocking functions:

- You can block at most $n-1$ input groups.
- You cannot block an input group that is already blocked.
- You cannot block an input group when it receives data from the same source as another input group.
- You cannot unblock an input group that is already unblocked.

PowerCenter provides the following blocking functions:

- **INFA_CTBlockInputFlow()**. Allows the procedure to block an input group.

Use the following syntax:

```
INFA_STATUS INFA_CTBlockInputFlow(INFA_CT_INPUTGROUP_HANDLE group);
```

- **INFA_CTUnblockInputFlow()**. Allows the procedure to unblock an input group.

Use the following syntax:

```
INFA_STATUS INFA_CTUnblockInputFlow(INFA_CT_INPUTGROUP_HANDLE group);
```

The following table describes the argument for this function:

Argument	Datatype	Input/Output	Description
group	INFA_CT_INPUTGROUP_HANDLE	Input	Input group handle.

The return value datatype is INFA_STATUS. Use INFA_SUCCESS and INFA_FAILURE for the return value.

Verify Blocking

When you use the INFA_CTBlockInputFlow() and INFA_CTUnblockInputFlow() functions in the procedure code, verify the procedure checks whether or not the Integration Service allows the Custom transformation to block incoming data. To do this, check the value of the INFA_CT_TRANS_MAY_BLOCK_DATA propID using the INFA_CTGetInternalPropertyBool() function.

When the value of the INFA_CT_TRANS_MAY_BLOCK_DATA propID is FALSE, the procedure should either not use the blocking functions, or it should return a fatal error and stop the session.

If the procedure code uses the blocking functions when the Integration Service does not allow the Custom transformation to block data, the Integration Service might fail the session.

Pointer Functions

Use the pointer functions when you want the Integration Service to create and access pointers to an object or a structure.

PowerCenter provides the following pointer functions:

- **INFA_CTGetUserDefinedPtr()**. Allows the procedure to access an object or structure during run time.

Use the following syntax:

```
void* INFA_CTGetUserDefinedPtr(INFA_CT_HANDLE handle)
```

The following table describes the argument for this function:

Argument	Datatype	Input/Output	Description
handle	INFA_CT_HANDLE	Input	Handle name.

- **INFA_CTSetUserDefinedPtr()**. Allows the procedure to associate an object or a structure with any handle the Integration Service provides. To reduce processing overhead, include this function in the initialization functions.

Use the following syntax:

```
void INFA_CTSetUserDefinedPtr(INFA_CT_HANDLE handle, void* pPtr)
```

The following table describes the arguments for this function:

Argument	Datatype	Input/Output	Description
handle	INFA_CT_HANDLE	Input	Handle name.
pPtr	void*	Input	User pointer.

You must substitute a valid handle for INFA_CT_HANDLE.

Change String Mode Function

When the Integration Service runs in Unicode mode, it passes data to the procedure in UCS-2 by default. When it runs in ASCII mode, it passes data in ASCII by default. Use the INFA_CTChangeStringMode() function if you want to change the default string mode for the procedure. When you change the default string mode to MBCS, the Integration Service passes data in the Integration Service code page. Use the INFA_CTSetDataCodePageID() function if you want to change the code page.

When a procedure includes the INFA_CTChangeStringMode() function, the Integration Service changes the string mode for all ports in each Custom transformation that use this particular procedure.

Use the change string mode function in the initialization functions.

Use the following syntax:

```
INFA_STATUS INFA_CTChangeStringMode(INFA_CT_PROCEDURE_HANDLE procedure,  
INFA_CTStringMode stringMode);
```

The following table describes the arguments for this function:

Argument	Datatype	Input/Output	Description
procedure	INFA_CT_PROCEDURE_HANDLE	Input	Procedure handle name.
stringMode	INFA_CTStringMode	Input	Specifies the string mode that you want the Integration Service to use. Use the following values for the stringMode parameter: <ul style="list-style-type: none">- eASM_UNICODE. Use this when the Integration Service runs in ASCII mode and you want the procedure to access data in Unicode.- eASM_MBCS. Use this when the Integration Service runs in Unicode mode and you want the procedure to access data in MBCS.

The return value datatype is INFA_STATUS. Use INFA_SUCCESS and INFA_FAILURE for the return value.

Set Data Code Page Function

Use the INFA_CTSetDataCodePageID() when you want the Integration Service to pass data to the Custom transformation in a code page other than the Integration Service code page.

Use the set data code page function in the procedure initialization function.

Use the following syntax:

```
INFA_STATUS INFA_CTSetDataCodePageID(INFA_CT_TRANSFORMATION_HANDLE transformation, int
dataCodePageID);
```

The following table describes the arguments for this function:

Argument	Datatype	Input/Output	Description
transformation	INFA_CT_TRANSFORMATION_HANDLE	Input	Transformation handle name.
dataCodePageID	int	Input	Specifies the code page you want the Integration Service to pass data in. For valid values for the dataCodePageID parameter, see "Code Pages" in the <i>Administrator Guide</i> .

The return value datatype is INFA_STATUS. Use INFA_SUCCESS and INFA_FAILURE for the return value.

Row Strategy Functions (Row-Based Mode)

The row strategy functions allow you to access and configure the update strategy for each row.

PowerCenter provides the following row strategy functions:

- **INFA_CTGetRowStrategy()**. Allows the procedure to get the update strategy for a row.

Use the following syntax:

```
INFA_STATUS INFA_CTGetRowStrategy(INFA_CT_INPUTGROUP_HANDLE group,
INFA_CTUPDATESTRATEGY updateStrategy);
```

The following table describes the arguments for this function:

Argument	Datatype	Input/Output	Description
group	INFA_CT_INPUTGROUP_HANDLE	Input	Input group handle.
updateStrategy	INFA_CT_UPDATESTRATEGY	Input	Update strategy for the input port. The Integration Service uses the following values: - eUS_INSERT = 0 - eUS_UPDATE = 1 - eUS_DELETE = 2 - eUS_REJECT = 3

- **INFA_CTSetRowStrategy()**. Sets the update strategy for each row. This overrides the INFA_CTChangeDefaultRowStrategy function.

Use the following syntax:

```
INFA_STATUS INFA_CTSetRowStrategy(INFA_CT_OUTPUTGROUP_HANDLE group,
INFA_CT_UPDATESTRATEGY updateStrategy);
```

The following table describes the arguments for this function:

Argument	Datatype	Input/Output	Description
group	INFA_CT_OUTPUTGROUP_HANDLE	Input	Output group handle.
updateStrategy	INFA_CT_UPDATESTRATEGY	Input	Update strategy you want to set for the output port. Use one of the following values: <ul style="list-style-type: none"> - eUS_INSERT = 0 - eUS_UPDATE = 1 - eUS_DELETE = 2 - eUS_REJECT = 3

The return value datatype is INFA_STATUS. Use INFA_SUCCESS and INFA_FAILURE for the return value.

Change Default Row Strategy Function

By default, the row strategy for a Custom transformation is pass-through when the transformation scope is Row. When the transformation scope is Transaction or All Input, the row strategy is the same value as the Treat Source Rows As session property by default.

For example, in a mapping you have an Update Strategy transformation followed by a Custom transformation with Row transformation scope. The Update Strategy transformation flags the rows for update, insert, or delete. When the Integration Service passes a row to the Custom transformation, the Custom transformation retains the flag since its row strategy is pass-through.

However, you can change the row strategy of a Custom transformation with PowerCenter. Use the INFA_CTChangeDefaultRowStrategy() function to change the default row strategy at the transformation level. For example, when you change the default row strategy of a Custom transformation to insert, the Integration Service flags all the rows that pass through this transformation for insert.

Note: The Integration Service returns INFA_FAILURE if the session is not in data-driven mode.

Use the following syntax:

```
INFA_STATUS INFA_CTChangeDefaultRowStrategy(INFA_CT_TRANSFORMATION_HANDLE
transformation, INFA_CT_DefaultUpdateStrategy defaultUpdateStrategy);
```

The following table describes the arguments for this function:

Argument	Datatype	Input/Output	Description
transformation	INFA_CT_TRANSFORMATION_HANDLE	Input	Transformation handle.
defaultUpdateStrategy	INFA_CT_DefaultUpdateStrategy	Input	Specifies the row strategy you want the Integration Service to use for the Custom transformation. <ul style="list-style-type: none"> - eDUS_PASSTHROUGH. Flags the row for passthrough. - eDUS_INSERT. Flags rows for insert. - eDUS_UPDATE. Flags rows for update. - eDUS_DELETE. Flags rows for delete.

The return value datatype is INFA_STATUS. Use INFA_SUCCESS and INFA_FAILURE for the return value.

Array-Based API Functions

The array-based functions are API functions you use when you change the data access mode to array-based.

Informatica provides the following groups of array-based API functions:

- Maximum number of rows
- Number of rows
- Is row valid
- Data handling (array-based mode)
- Row strategy
- Set input error row

Maximum Number of Rows Functions

By default, the Integration Service allows a maximum number of rows in an input block and an output block. However, you can change the maximum number of rows allowed in an output block.

Use the INFA_CTAGetInputNumRowsMax() and INFA_CTAGetOutputNumRowsMax() functions to determine the maximum number of rows in input and output blocks. Use the values these functions return to determine the buffer size if the procedure needs a buffer.

You can set the maximum number of rows in the output block using the INFA_CTASetOutputRowMax() function. You might use this function if you want the procedure to use a larger or smaller buffer.

You can only call these functions in an initialization function.

PowerCenter provides the following functions to determine and set the maximum number of rows in blocks:

- **INFA_CTAGetInputNumRowsMax()**. Use this function to determine the maximum number of rows allowed in an input block.

Use the following syntax:

```
IINT32 INFA_CTAGetInputRowMax( INFA_CT_INPUTGROUP_HANDLE inputgroup );
```

The following table describes the argument for this function:

Argument	Datatype	Input/Output	Description
inputgroup	INFA_CT_INPUTGROUP_HANDLE	Input	Input group handle.

- **INFA_CTAGetOutputNumRowsMax()**. Use this function to determine the maximum number of rows allowed in an output block.

Use the following syntax:

```
IINT32 INFA_CTAGetOutputRowMax( INFA_CT_OUTPUTGROUP_HANDLE outputgroup );
```

The following table describes the argument for this function:

Argument	Datatype	Input/Output	Description
outputgroup	INFA_CT_OUTPUTGROUP_HANDLE	Input	Output group handle.

- **INFA_CTASetOutputRowMax()**. Use this function to set the maximum number of rows allowed in an output block.

Use the following syntax:

```
INFA_STATUS INFA_CTASetOutputRowMax( INFA_CT_OUTPUTGROUP_HANDLE outputgroup,  
INFA_INT32 nRowMax );
```

The following table describes the arguments for this function:

Argument	Datatype	Input/Output	Description
outputgroup	INFA_CT_OUTPUTGROUP_HANDLE	Input	Output group handle.
nRowMax	INFA_INT32	Input	Maximum number of rows you want to allow in an output block. You must enter a positive number. The function returns a fatal error when you use a non-positive number, including zero.

Number of Rows Functions

Use the number of rows functions to determine the number of rows in an input block, or to set the number of rows in an output block for the specified input or output group.

PowerCenter provides the following number of rows functions:

- **INFA_CTAGetNumRows()**. You can determine the number of rows in an input block.

Use the following syntax:

```
INFA_INT32 INFA_CTAGetNumRows( INFA_CT_INPUTGROUP_HANDLE inputgroup );
```

The following table describes the argument for this function:

Argument	Datatype	Input/Output	Description
inputgroup	INFA_CT_INPUTGROUP_HANDLE	Input	Input group handle.

- **INFA_CTASetNumRows()**. You can set the number of rows in an output block. Call this function before you call the output notification function.

Use the following syntax:

```
void INFA_CTASetNumRows( INFA_CT_OUTPUTGROUP_HANDLE outputgroup, INFA_INT32 nRows );
```

The following table describes the arguments for this function:

Argument	Datatype	Input/Output	Description
outputgroup	INFA_CT_OUTPUTGROUP_HANDLE	Input	Output port handle.
nRows	INFA_INT32	Input	Number of rows you want to define in the output block. You must enter a positive number. The Integration Service fails the output notification function when specify a non-positive number.

Is Row Valid Function

Some rows in a block may be dropped, filter, or error rows. Use the `INFA_CTAIsRowValid()` function to determine if a row in a block is valid. This function returns `INFA_TRUE` when a row is valid.

Use the following syntax:

```
INFA_BOOLEAN INFA_CTAIsRowValid( INFA_CT_INPUTGROUP_HANDLE inputgroup, INFA_INT32 iRow);
```

The following table describes the arguments for this function:

Argument	Datatype	Input/Output	Description
inputgroup	INFA_CT_INPUTGROUP_HANDLE	Input	Input group handle.
iRow	INFA_INT32	Input	Index number of the row in the block. The index is zero-based. You must verify the procedure only passes an index number that exists in the data block. If you pass an invalid value, the Integration Service shuts down unexpectedly.

Data Handling Functions (Array-Based Mode)

When the Integration Service calls the `p_<proc_name>_inputRowNotification()` function, it notifies the procedure that the procedure can access a row or block of data. However, to get data from the input port, modify it, and set data in the output port in array-based mode, you must use the array-based data handling functions in the input row notification function.

Include the `INFA_CTAGetData<datatype>()` function to get the data from the input port and `INFA_CTASetData()` function to set the data in the output port. Include the `INFA_CTAGetIndicator()` function if you want the procedure to verify before you get the data if the port has a null value or an empty string.

PowerCenter provides the following data handling functions for the array-based data access mode:

- `INFA_CTAGetData<datatype>()`
- `INFA_CTAGetIndicator()`
- `INFA_CTASetData()`

Get Data Functions (Array-Based Mode)

Use the `INFA_CTAGetData<datatype>()` functions to retrieve data for the port the function specifies. You must modify the function name depending on the datatype of the port you want the procedure to access. The Integration Service passes the length of the data in the array-based get data functions.

The following table lists the `INFA_CTAGetData<datatype>()` function syntax and the datatype of the return value:

Syntax	Return Value Datatype
<code>void* INFA_CTAGetDataVoid(INFA_CT_INPUTPORT_HANDLE inputport, INFA_INT32 iRow, INFA_UINT32* pLength);</code>	Data void pointer to the return value
<code>char* INFA_CTAGetDataStringM(INFA_CT_INPUTPORT_HANDLE inputport, INFA_INT32 iRow, INFA_UINT32* pLength);</code>	String (MBCS)
<code>IUNICHAR* INFA_CTAGetDataStringU(INFA_CT_INPUTPORT_HANDLE inputport, INFA_INT32 iRow, INFA_UINT32* pLength);</code>	String (Unicode)
<code>INFA_INT32 INFA_CTAGetDataINT32(INFA_CT_INPUTPORT_HANDLE inputport, INFA_INT32 iRow);</code>	Integer
<code>double INFA_CTAGetDataDouble(INFA_CT_INPUTPORT_HANDLE inputport, INFA_INT32 iRow);</code>	Double
<code>INFA_CT_RAWDATETIME INFA_CTAGetDataRawDate(INFA_CT_INPUTPORT_HANDLE inputport, INFA_INT32 iRow);</code>	Raw date
<code>INFA_CT_DATETIME INFA_CTAGetDataDateTime(INFA_CT_INPUTPORT_HANDLE inputport, INFA_INT32 iRow);</code>	Datetime
<code>INFA_CT_RAWDEC18 INFA_CTAGetDataRawDec18(INFA_CT_INPUTPORT_HANDLE inputport, INFA_INT32 iRow);</code>	Decimal BLOB (precision 18)
<code>INFA_CT_RAWDEC28 INFA_CTAGetDataRawDec28(INFA_CT_INPUTPORT_HANDLE inputport, INFA_INT32 iRow);</code>	Decimal BLOB (precision 28)

Get Indicator Function (Array-Based Mode)

Use the get indicator function when you want the procedure to verify if the input port has a null value.

Use the following syntax:

```
INFA_INDICATOR INFA_CTGetIndicator( INFA_CT_INPUTPORT_HANDLE inputport, INFA_INT32 iRow );
```

The following table describes the arguments for this function:

Argument	Datatype	Input/Output	Description
inputport	INFA_CT_INPUTPORT_HANDLE	Input	Input port handle.
iRow	INFA_INT32	Input	Index number of the row in the block. The index is zero-based. You must verify the procedure only passes an index number that exists in the data block. If you pass an invalid value, the Integration Service shuts down unexpectedly.

The return value datatype is INFA_INDICATOR. Use the following values for INFA_INDICATOR:

- **INFA_DATA_VALID.** Indicates the data is valid.
- **INFA_NULL_DATA.** Indicates a null value.
- **INFA_DATA_TRUNCATED.** Indicates the data has been truncated.

Set Data Function (Array-Based Mode)

Use the set data function when you want the procedure to pass a value to an output port. You can set the data, the length of the data, if applicable, and the indicator for the output port you specify. You do not use separate functions to set the length or indicator for the output port.

Use the following syntax:

```
void INFA_CTASetData( INFA_CT_OUTPUTPORT_HANDLE outputport, INFA_INT32 iRow, void* pData, INFA_UINT32 nLength, INFA_INDICATOR indicator);
```

The following table describes the arguments for this function:

Argument	Datatype	Input/Output	Description
outputport	INFA_CT_OUTPUTPORT_HANDLE	Input	Output port handle.
iRow	INFA_INT32	Input	Index number of the row in the block. The index is zero-based. You must verify the procedure only passes an index number that exists in the data block. If you pass an invalid value, the Integration Service shuts down unexpectedly.
pData	void*	Input	Pointer to the data.

Argument	Datatype	Input/Output	Description
nLength	INFA_UINT32	Input	Length of the port. Use for string and binary ports only. You must verify the function passes the correct length of the data. If the function passes a different length, the output notification function returns failure for this port. Verify the length you set for string and binary ports is not greater than the precision for the port. If you set the length greater than the port precision, you get unexpected results. For example, the session may fail.
indicator	INFA_INDICATOR	Input	Indicator value for the output port. Use one of the following values: - INFA_DATA_VALID. Indicates the data is valid. - INFA_NULL_DATA. Indicates a null value. - INFA_DATA_TRUNCATED. Indicates the data has been truncated.

Row Strategy Functions (Array-Based Mode)

The array-based row strategy functions allow you to access and configure the update strategy for each row in a block.

PowerCenter provides the following row strategy functions:

- **INFA_CTARowStrategy()**. Allows the procedure to get the update strategy for a row in a block.

Use the following syntax:

```
INFA_CT_UPDATESTRATEGY INFA_CTARowStrategy( INFA_CT_INPUTGROUP_HANDLE inputgroup,
INFA_INT32 iRow);
```

The following table describes the arguments for this function:

Argument	Datatype	Input/Output	Description
inputgroup	INFA_CT_INPUTGROUP_HANDLE	Input	Input group handle.
iRow	INFA_INT32	Input	Index number of the row in the block. The index is zero-based. You must verify the procedure only passes an index number that exists in the data block. If you pass an invalid value, the Integration Service shuts down unexpectedly.

- **INFA_CTASetRowStrategy()**. Sets the update strategy for a row in a block.

Use the following syntax:

```
void INFA_CTASetRowStrategy( INFA_CT_OUTPUTGROUP_HANDLE outputgroup, INFA_INT32 iRow,
INFA_CT_UPDATESTRATEGY updateStrategy );
```

The following table describes the arguments for this function:

Argument	Datatype	Input/Output	Description
outputgroup	INFA_CT_OUTPUTGROUP_HANDLE	Input	Output group handle.
iRow	INFA_INT32	Input	Index number of the row in the block. The index is zero-based. You must verify the procedure only passes an index number that exists in the data block. If you pass an invalid value, the Integration Service shuts down unexpectedly.
updateStrategy	INFA_CT_UPDATESTRATEGY	Input	Update strategy for the port. Use one of the following values: <ul style="list-style-type: none">- eUS_INSERT = 0- eUS_UPDATE = 1- eUS_DELETE = 2- eUS_REJECT = 3

Set Input Error Row Functions

When you use array-based access mode, you cannot return `INFA_ROWERROR` in the input row notification function. Instead, use the set input error row functions to notify the Integration Service that a particular input row has an error.

PowerCenter provides the following set input row functions in array-based mode:

- **INFA_CTASetInputErrorRowM()**. You can notify the Integration Service that a row in the input block has an error and to output an MBCS error message to the session log.

Use the following syntax:

```
INFA_STATUS INFA_CTASetInputErrorRowM( INFA_CT_INPUTGROUP_HANDLE inputGroup,
INFA_INT32 iRow, size_t nErrors, INFA_MBCSCHAR* sErrMsg );
```

The following table describes the arguments for this function:

Argument	Datatype	Input/Output	Description
inputGroup	INFA_CT_INPUTGROUP_HANDLE	Input	Input group handle.
iRow	INFA_INT32	Input	Index number of the row in the block. The index is zero-based. You must verify the procedure only passes an index number that exists in the data block. If you pass an invalid value, the Integration Service shuts down unexpectedly.
nErrors	size_t	Input	Use this parameter to specify the number of errors this input row has caused.
sErrMsg	INFA_MBCSCHAR*	Input	MBCS string containing the error message you want the function to output. You must enter a null-terminated string. This parameter is optional. When you include this argument, the Integration Service prints the message in the session log, even when you enable row error logging.

- **INFA_CTASetInputErrorRowU()**. You can notify the Integration Service that a row in the input block has an error and to output a Unicode error message to the session log.

Use the following syntax:

```
INFA_STATUS INFA_CTASetInputErrorRowU( INFA_CT_INPUTGROUP_HANDLE inputGroup,
INFA_INT32 iRow, size_t nErrors, INFA_UNICHAR* sErrMsg );
```

The following table describes the arguments for this function:

Argument	Datatype	Input/Output	Description
inputGroup	INFA_CT_INPUTGROUP_HANDLE	Input	Input group handle.
iRow	INFA_INT32	Input	Index number of the row in the block. The index is zero-based. You must verify the procedure only passes an index number that exists in the data block. If you pass an invalid value, the Integration Service shuts down unexpectedly.

Argument	Datatype	Input/ Output	Description
nErrors	size_t	Input	Use this parameter to specify the number of errors this output row has caused.
sErrMsg	INFA_UNICHAR*	Input	<p>Unicode string containing the error message you want the function to output. You must enter a null-terminated string.</p> <p>This parameter is optional. When you include this argument, the Integration Service prints the message in the session log, even when you enable row error logging.</p>

CHAPTER 5

Data Masking Transformation

This chapter includes the following topics:

- [Data Masking transformation, 125](#)
- [Masking Properties, 126](#)
- [Key Masking, 128](#)
- [Substitution Masking, 130](#)
- [Dependent Masking, 134](#)
- [Random Masking, 135](#)
- [Applying Masking Rules, 137](#)
- [Expression Masking, 141](#)
- [Format Preserving Encryption, 143](#)
- [Special Mask Formats, 144](#)
- [Social Security Number Masking, 144](#)
- [Credit Card Number Masking, 145](#)
- [Phone Number Masking, 145](#)
- [Email Address Masking, 146](#)
- [Social Insurance Number Masking, 147](#)
- [IP Address Masking, 148](#)
- [URL Address Masking, 148](#)
- [Default Value File, 149](#)
- [Data Masking Transformation Session Properties, 149](#)
- [Rules and Guidelines for Data Masking Transformations, 150](#)

Data Masking transformation

Use the Data Masking transformation to change sensitive production data to realistic test data for non-production environments. The Data Masking transformation modifies source data based on masking rules that you configure for each column.

Create masked data for software development, testing, training, and data mining. You can maintain data relationships in the masked data and maintain referential integrity between database tables. The Data Masking transformation is a passive transformation.

The Data Masking transformation provides masking rules based on the source data type and masking type you configure for a port. For strings, you can restrict the characters in a string to replace and the characters to apply in the mask. For numbers and dates, you can provide a range of numbers for the masked data. You can configure a range that is a fixed or percentage variance from the original number. The Integration Service replaces characters based on the locale that you configure with the masking rules.

To use the Data Masking transformation, you need the appropriate license.

RELATED TOPICS:

- [“Default Values for Ports” on page 38](#)
- [“Applying Masking Rules” on page 137](#)
- [“Default Value File” on page 149](#)

Masking Properties

Define the input ports and configure masking properties for each port on the Masking Properties tab. The type of masking you can select is based on the port datatype. When you choose a masking type, the Designer displays the masking rules for the masking type.

Locale

The locale identifies the language and region of the characters in the data. Choose a locale from the list. The Data Masking transformation masks character data with characters from the locale that you choose. The source data must contain characters that are compatible with the locale that you select.

If your locale is not in the list, select a locale that has a similar or matching code page. You cannot select Unicode for locale.

Masking Types

The masking type is the type of data masking to apply to the selected column. Select one of the following masking types:

- Key masking. Produces deterministic results for the same source data, masking rules, and seed value.
- Substitution masking. Replaces a column of data with similar but unrelated data from a dictionary.
- Dependent masking. Replaces the values of one source column based on the values of another source column.
- Random masking. Produces random results for the same source data and masking rules.
- Expression masking. Applies an expression to a port to change the data or create data.
- Special mask formats. Applies special mask formats to common types of sensitive data. You can mask social security numbers, social insurance numbers, credit card numbers, phone numbers, URL addresses, email addresses, or IP addresses.
- Substitution. Replaces a column of data with similar but unrelated data from a dictionary.
- No Masking. The Data Masking transformation does not change the source data.

Default is No Masking.

Repeatable Output

Repeatable output is the consistent set of values returned by the Data Masking transformation.

Repeatable output returns deterministic values. For example, you configure repeatable output for a column of first names. The Data Masking transformation returns the same masked values every time you include the transformation in a workflow.

You can configure repeatable masking for all the data masking types. To configure repeatable masking click **Repeatable Output** and select **Seed Value**.

Seed

The seed value is a starting point to generate masked values.

The Data Masking transformation creates a default seed value that is a random number between 1 and 1,000. You can enter a different seed value or apply a mapping parameter value. Apply the same seed value to a column to return the same masked data values in different source data. For example, if you have the same Cust_ID column in four tables, and you want all of them to output the same masked values, set all four columns to the same seed value.

Mapping Parameters

You can use a mapping parameter to define a seed value. Create a mapping parameter for each seed value that you want to add to the transformation. The mapping parameter value is a number between 1 and 1,000.

When you configure data masking for a column, select Mapping Parameter for the seed. The Designer displays a list of the mapping parameters. Select a mapping parameter from the list. Before you run a session, you can change the mapping parameter value in a parameter file for the session.

Create the mapping parameters before you create the Data Masking transformation. If you choose to parametrize the seed value and the mapping has no mapping parameters, an error appears. If you select a port with a masking rule that references a deleted mapping parameter, the Designer generates a new random seed value for the port. The seed value is not a mapping parameter. A message appears that the mapping parameter is deleted and the Designer creates a new seed value.

The Integration Service applies a default seed value in the following circumstances:

- The mapping parameter option is selected for a column but the session has no parameter file.
- You delete the mapping parameter.
- A mapping parameter seed value is not between 1 and 1,000.

The Integration Service applies masked values from the default value file. You can edit the default value file to change the default values.

The default value file is an XML file in the following location:

```
<PowerCenter Installation Directory>\infa_shared\SrcFiles\defaultValue.xml
```

The name-value pair for the seed is

```
default_seed = "500".
```

If the seed value in the default value file is not between 1 and 1,000, the Integration Service assigns a value of 725 to the seed and writes a message in the session log.

RELATED TOPICS:

- [“Default Value File” on page 149](#)

Associated O/P

The Associated O/P is the associated output port for an input port. The Data Masking transformation creates an output port for each input port. The naming convention is out_<port name>. The associated output port is a read-only port.

Key Masking

A column configured for key masking returns deterministic masked data each time the source value and seed value are the same. The Data Masking transformation returns unique values for the column.

When you configure a column for key masking, the Data Masking transformation creates a seed value for the column. You can change the seed value to produce repeatable data between different Data Masking transformations. For example, configure key masking to enforce referential integrity. Use the same seed value to mask a primary key in a table and the foreign key value in another table.

You can define masking rules that affect the format of data that the Data Masking transformation returns. Mask string and numeric values with key masking.

Masking String Values

You can configure key masking for strings to generate repeatable output. Configure a mask format to define limitations for each character in the output string, define a mask format. Configure source string characters and result string replacement characters that define the source characters to mask and the characters to mask them with.

The following figure shows key masking properties for a string datatype:

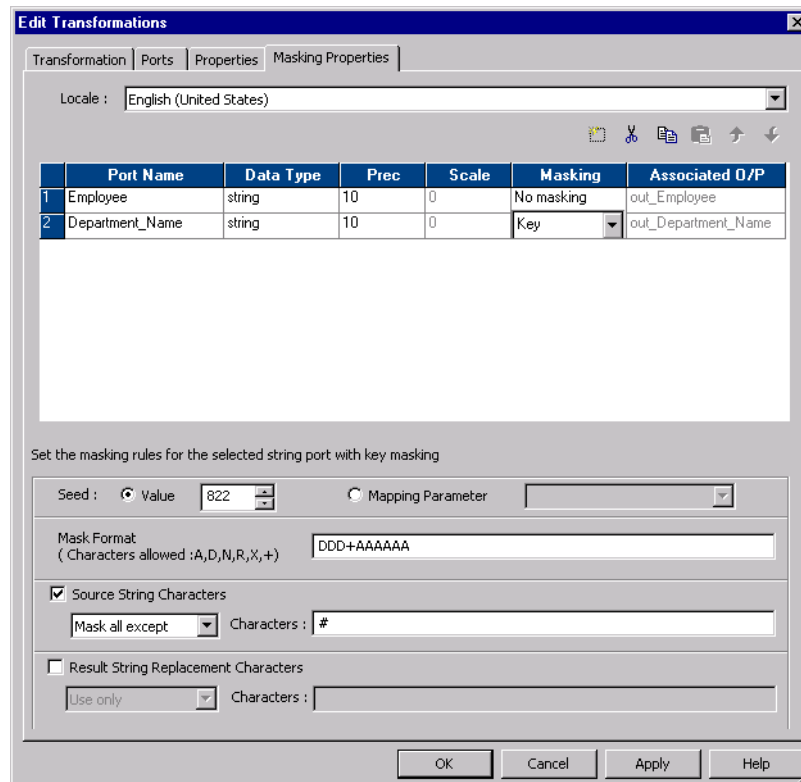

You can configure the following masking rules for key masking string values:

- **Seed.** Apply a seed value to generate deterministic masked data for a column. Select one of the following options:
 - **Value.** Accept the default seed value or enter a number between 1 and 1,000.
 - **Mapping Parameter.** Use a mapping parameter to define the seed value. The Designer displays a list of the mapping parameters that you create for the mapping. Choose the mapping parameter from the list to use as the seed value.
- **Mask Format.** Define the type of character to substitute for each character in the input data. You can limit each character to an alphabetic, numeric, or alphanumeric character type.
- **Source String Characters.** Define the characters in the source string that you want to mask. For example, mask the number sign (#) character whenever it occurs in the input data. The Data Masking transformation masks all the input characters when Source String Characters is blank. The Data Masking transformation does not always return unique data if the number of source string characters is less than the number of result string characters.
- **Result String Characters.** Substitute the characters in the target string with the characters you define in Result String Characters. For example, enter the following characters to configure each mask to contain all uppercase alphabetic characters:

ABCDEFGHIJKLMNOPQRSTUVWXYZ

Masking Numeric Values

Configure key masking for numeric source data to generate deterministic output. When you configure a column for numeric key masking, you assign a random seed value to the column. When the Data Masking transformation masks the source data, it applies a masking algorithm that requires the seed.

You can change the seed value for a column to produce repeatable results if the same source value occurs in a different column. For example, you want to maintain a primary-foreign key relationship between two tables. In each Data Masking transformation, enter the same seed value for the primary-key column as the seed value for the foreign-key column. The Data Masking transformation produces deterministic results for the same numeric values. The referential integrity is maintained between the tables.

Masking Datetime Values

When you can configure key masking for datetime values, the Data Masking transformation requires a random number as a seed. You can change the seed to match the seed value for another column in order to return repeatable datetime values between the columns.

The Data Masking transformation can mask dates between 1753 and 2400 with key masking. If the source year is in a leap year, the Data Masking transformation returns a year that is also a leap year. If the source month contains 31 days, the Data Masking transformation returns a month that has 31 days. If the source month is February, the Data Masking transformation returns February.

The Data Masking transformation always generates valid dates.

RELATED TOPICS:

- [“Date Range ” on page 140](#)

Substitution Masking

Substitution masking replaces a column of data with similar but unrelated data. Use substitution masking to replace production data with realistic test data. When you configure substitution masking, define the dictionary that contains the substitute values.

The Data Masking transformation performs a lookup on the dictionary that you configure. The Data Masking transformation replaces source data with data from the dictionary. Dictionary files can contain string data, datetime values, integers, and floating point numbers. Enter datetime values in the following format:

`mm/dd/yyyy`

You can substitute data with repeatable or non-repeatable values. When you choose repeatable values, the Data Masking transformation produces deterministic results for the same source data and seed value. You must configure a seed value to substitute data with deterministic results. The Integration Service maintains a storage table of source and masked values for repeatable masking.

You can substitute more than one column of data with masked values from the same dictionary row. Configure substitution masking for one input column. Configure dependent data masking for the other columns that receive masked data from the same dictionary row.

Dictionaries

A dictionary is a flat file or relational table that contains the substitute data for each row in the file. The Data Masking transformation generates a number to retrieve a dictionary row. The Data Masking transformation generates a hash key for repeatable substitution masking or a random number for non-repeatable masking. You can configure an additional lookup condition.

You can configure a dictionary to mask more than one port in the Data Masking transformation.

The following example shows a flat file dictionary that contains first name and gender:

```
SNO,GENDER,FIRSTNAME
1,M,Adam
2,M,Adeel
3,M,Adil
4,F,Alice
5,F,Alison
```

In this dictionary, the first field in the row is the serial number, and the second field is gender. You can add gender as a lookup condition. The Integration Service retrieves a row from the dictionary using a hash key, and it finds a row with a gender that matches the gender in the source data.

Use the following rules and guidelines when you create a dictionary:

- The first row of a flat file dictionary must have column labels to identify the fields in each record. The fields are separated by commas. If the first row does not contain column labels, the Integration Service takes the values of the fields in the first row as column names.
- A flat file dictionary must be in the \$PMLookupFileDir lookup file directory. By default, this directory is in the following location:

```
<PowerCenter_Installation_Directory>\server\infa_shared\LkpFiles
```

- If you create a flat file dictionary on Windows and copy it to a UNIX machine, verify that the file format is correct for UNIX. For example, Windows and UNIX use different characters for the end of line marker.
- If you configure substitution masking for more than one port, all relational dictionaries must be in the same database schema.
- The line sequential buffer length of a flat file dictionary must be less than or equal to 600 characters.
- You cannot change the dictionary type or the substitution dictionary name in session properties.

Storage Tables

The Data Masking transformation maintains storage tables for repeatable substitution between sessions. A storage table row contains the source column and a masked value pair. Each time the Data Masking transformation masks a value with a repeatable substitute value, it searches the storage table by dictionary name, locale, column name, input value, and seed. If it finds a row, it returns the masked value from the storage table. If the Data Masking transformation does not find a row, it retrieves a row from the dictionary with a hash key.

The dictionary name format in the storage table is different for a flat file dictionary and a relational dictionary. A flat file dictionary name is identified by the file name. The relational dictionary name has the following syntax:

```
<Connection object>_<dictionary table name>
```

Informatica provides scripts that you can run to create a relational storage table. The scripts are in the following location:

```
<PowerCenter Client installation directory>\client\bin\Extensions\DataMasking
```

The directory contains a script for Sybase, Microsoft SQL Server, IBM DB2, and Oracle databases. Each script is named Substitution_<database type>. You can create a table in a different database if you configure the SQL statements and the primary key constraints.

You need to encrypt storage tables for substitution masking when you have unencrypted data in the storage and use the same seed value and dictionary to encrypt the same columns.

Encrypting Storage Tables for Substitution Masking

You can use transformation language encoding functions to encrypt storage tables. You need to encrypt storage tables when you have enabled storage encryption.

1. Create a mapping with the `IDM_SUBSTITUTION_STORAGE` storage table as source.
2. Create a Data Masking transformation.
3. Apply the substitution masking technique on the input value and the masked value ports.
4. Use the following expression on the `INPUTVALUE` port:

```
Enc_Base64(AES_Encrypt(INPUTVALUE, Key))
```

5. Use the following expression on the `MASKEDVALUE` port:

```
Enc_Base64(AES_Encrypt(MASKEDVALUE, Key))
```

6. Link the ports to the target.

Substitution Masking Properties

You can configure the following masking rules for substitution masking:

- **Repeatable Output.** Returns deterministic results between sessions. The Data Masking transformation stores masked values in the storage table.
- **Seed.** Apply a seed value to generate deterministic masked data for a column. Select one of the following options:
 - **Value.** Accept the default seed value or enter a number between 1 and 1,000.
 - **Mapping Parameter.** Use a mapping parameter to define the seed value. The Designer displays a list of the mapping parameters that you create for the mapping. Choose the mapping parameter from the list to use as the seed value.
 - **Unique Output.** Force the Data Masking transformation to create unique output values for unique input values. No two input values are masked to the same output value. The dictionary must have enough unique rows to enable unique output.
When you disable unique output, the Data Masking transformation might not mask input values to unique output values. The dictionary might contain fewer rows.
 - **Unique Key Column.** The source column on which the masking technique is applied.
 - **Optimize Dictionary Usage.** Applicable if you select the **Repeatable Output** option. Increases the usage of masked values from a dictionary.
- **Dictionary Information.** Configure the flat file or relational table that contains the substitute data values.
 - **Relational Table.** Select Relational Table if the dictionary is in a database table. Click Select Table to configure the database and table.
 - **Flat File.** Select Flat File if the dictionary is in flat file delimited by commas. Click Select Flat File to browse for and choose a file.
 - **Dictionary Name.** Displays the flat file or relational table name that you selected.
 - **Output Column.** Choose the column to return to the Data Masking transformation.
 - **Sort Column.** The dictionary column on which you want to sort entries. Specify a sort column to generate deterministic results even if the order of entries in the dictionary changes. For example, if you move a relational dictionary and the order of entries changes, sort on the serial number column to consistently mask the data.
Note: The column that you choose must contain unique values. You cannot use a column that might contain duplicate values to sort the data.

- **Lookup condition.** Configure a lookup condition to further qualify what dictionary row to use for substitution masking. The lookup condition is similar to the WHERE clause in an SQL query. When you configure a lookup condition you compare the value of a column in the source with a column in the dictionary.

For example, you want to mask the first name. The source data and the dictionary have a first name column and a gender column. You can add a condition that each female first name is replaced with a female name from the dictionary. The lookup condition compares gender in the source to gender in the dictionary.

- **Input port.** Source data column to use in the lookup.
- **Dictionary column.** Dictionary column to compare the input port to.

Relational Dictionary

When you choose a relational table as a dictionary, configure the database table that contains the dictionary. When you define the table, the Designer connects to the table and displays the columns in the table.

To select a database, click Select Table on the Data Masking transformation Masking Properties tab.

Configure the following fields in the Select Table dialog box:

- **ODBC data source.** ODBC data source that connects to the database that contains the dictionary.
- **User Name.** A database user name to connect to the database. The user name must have the database permissions to view the tables.
- **Owner Name.** If the user name is not the owner of the dictionary table, enter the table owner.
- **Password.** The password for the database user name.
- **Search for tables named.** Optional. Limits the number of tables that appear in the dialog box.

When you click Connect, the Designer connects to the data source and displays the tables. Scroll through the list of tables and select the table you want to use for the dictionary. The table name appears in the Dictionary Name field of the Masking Properties tab.

Connection Requirements

You must configure a database connection for the storage table and relational dictionary if you use them with substitution masking.

Configure the database connections in the Workflow Manager. Select a relational connection object for the IDM_Dictionary connection and the IDM_Storage connection on the Mapping tab of the session properties.

Rules and Guidelines for Substitution Masking

Use the following rules and guidelines for substitution masking:

- If a storage table does not exist for a unique repeatable substitution mask, the session fails.
- If the dictionary contains no rows, the Data Masking transformation returns an error message.
- When the Data Masking transformation finds an input value with the locale, dictionary, and seed in the storage table, it retrieves the masked value, even if the row is no longer in the dictionary.
- If you delete a connection object or modify the dictionary, truncate the storage table. Otherwise, you might get unexpected results.
- If the number of values in the dictionary is less than the number of unique values in the source data, the Data Masking Transformation cannot mask the data with unique repeatable values. The Data Masking transformation returns an error message.

Dependent Masking

Dependent masking substitutes multiple columns of source data with data from the same dictionary row.

When the Data Masking transformation performs substitution masking for multiple columns, the masked data might contain unrealistic combinations of fields. You can configure dependent masking in order to substitute data for multiple input columns from the same dictionary row. The masked data receives valid combinations such as, "New York, New York" or "Chicago, Illinois."

When you configure dependent masking, you first configure an input column for substitution masking. Configure other input columns to be dependent on that substitution column. For example, you choose the ZIP code column for substitution masking and choose city and state columns to be dependent on the ZIP code column. Dependent masking ensures that the substituted city and state values are valid for the substituted ZIP code value.

Note: You cannot configure a column for dependent masking without first configuring a column for substitution masking.

Configure the following masking rules when you configure a column for dependent masking:

Dependent column

The name of the input column that you configured for substitution masking. The Data Masking transformation retrieves substitute data from a dictionary using the masking rules for that column. The column you configure for substitution masking becomes the key column for retrieving masked data from the dictionary.

Output column

The name of the dictionary column that contains the value for the column you are configuring with dependent masking.

Dependent Masking Example

A data masking dictionary might contain address rows with the following values:

```
SNO, STREET, CITY, STATE, ZIP, COUNTRY
1, 32 Apple Lane, Chicago, IL, 61523, US
2, 776 Ash Street, Dallas, TX, 75240, US
3, 2229 Big Square, Atleeville, TN, 38057, US
4, 6698 Cowboy Street, Houston, TX, 77001, US
```

You need to mask source data with valid combinations of the city, state, and ZIP code from the Address dictionary.

Configure the ZIP port for substitution masking.

Enter the following masking rules for the ZIP port:

Rule	Value
Dictionary FileType	Flat file or relational table
Dictionary Name	Address.dic
Output Column	ZIP

Configure the City port for dependent masking.

Enter the following masking rules for the City port:

Rule	Value
Dependent Column	ZIP
Output Column	City

Configure the State port for dependent masking.

Enter the following masking rules for the State port:

Rule	Value
Dependent Column	ZIP
Output Column	State

When the Data Masking transformation masks the ZIP code, it returns the correct city and state for the ZIP code from the dictionary row.

Repeatable Dependent Masking

When you configure multiple input fields to receive masked data from the same dictionary row, you need to decide which field to configure for substitution masking. With repeatable masking, select a column that uniquely identifies the source data. The Data Masking transformation uses the key field to determine if a row already exists in storage for repeatable masking.

Note: When the source data has a primary key, you can configure the primary key column for substitution masking. Configure another column for dependent masking.

For example, if you mask employee data, you might configure the EmployeeID for substitution masking, and configure FirstName and LastName for dependent masking.

When you configure repeatable masking, the following rows receive different masked data:

```
EmployeeID  FirstName  LastName
111         John      Jones
222         Radhika  Jones
```

If you choose LastName as the key field for repeatable dependent masking, each row with the last name Jones receives the same mask data.

Random Masking

Random masking generates random nondeterministic masked data. The Data Masking transformation returns different values when the same source value occurs in different rows. You can define masking rules that affect the format of data that the Data Masking transformation returns. Mask numeric, string, and date values with random masking.

Masking Numeric Values

When you mask numeric data, you can configure a range of output values for a column. The Data Masking transformation returns a value between the minimum and maximum values of the range depending on port precision. To define the range, configure the minimum and maximum ranges or configure a blurring range based on a variance from the original source value.

You can configure the following masking parameters for numeric data:

Range

Define a range of output values. The Data Masking transformation returns numeric data between the minimum and maximum values.

Blurring Range

Define a range of output values that are within a fixed variance or a percentage variance of the source data. The Data Masking transformation returns numeric data that is close to the value of the source data. You can configure a range and a blurring range.

Masking String Values

Configure random masking to generate random output for string columns. To configure limitations for each character in the output string, configure a mask format. Configure filter characters to define which source characters to mask and the characters to mask them with.

You can apply the following masking rules for a string port:

Range

Configure the minimum and maximum string length. The Data Masking transformation returns a string of random characters between the minimum and maximum string length.

Mask Format

Define the type of character to substitute for each character in the input data. You can limit each character to an alphabetic, numeric, or alphanumeric character type.

Source String Characters

Define the characters in the source string that you want to mask. For example, mask the number sign (#) character whenever it occurs in the input data. The Data Masking transformation masks all the input characters when Source String Characters is blank.

Result String Replacement Characters

Substitute the characters in the target string with the characters you define in Result String Characters. For example, enter the following characters to configure each mask to contain uppercase alphabetic characters A - Z:

ABCDEFGHIJKLMNOPQRSTUVWXYZ

Masking Date Values

To mask date values with random masking, either configure a range of output dates or choose a variance. When you configure a variance, choose a part of the date to blur. Choose the year, month, day, hour, minute, or second. The Data Masking transformation returns a date that is within the range you configure.

You can configure the following masking rules when you mask a datetime value:

Range

Sets the minimum and maximum values to return for the selected datetime value.

Blurring

Masks a date based on a variance that you apply to a unit of the date. The Data Masking transformation returns a date that is within the variance. You can blur the year, month, day, hour, minute, or second. Choose a low and high variance to apply.

Applying Masking Rules

Apply masking rules based on the source datatype. When you click a column property on the Masking Properties tab, the Designer displays masking rules based on the datatype of the port.

The following table describes the masking rules that you can configure based on the masking type and the source datatype:

Masking Types	Source Datatype	Masking Rules	Description
Random and Key	String	Mask Format	Mask that limits each character in an output string to an alphabetic, numeric, or alphanumeric character.
Random and Key	String	Source String Characters	Set of source characters to mask or to exclude from masking.
Random and Key	String	Result String Replacement Characters	A set of characters to include or exclude in a mask.
Random	Numeric String Date/Time	Range	A range of output values. <ul style="list-style-type: none">- Numeric. The Data Masking transformation returns numeric data between the minimum and maximum values.- String. Returns a string of random characters between the minimum and maximum string length.- Date/Time. Returns a date and time within the minimum and maximum datetime.
Random	Numeric Date/Time	Blurring	Range of output values with a fixed or percent variance from the source data. The Data Masking transformation returns data that is close to the value of the source data. Datetime columns require a fixed variance.

Mask Format

Configure a mask format to limit each character in the output column to an alphabetic, numeric, or alphanumeric character. Use the following characters to define a mask format:

A, D, N, X, +, R

Note: The mask format contains uppercase characters. When you enter a lowercase mask character, the Data Masking transformation converts the character to uppercase.

The following table describes mask format characters:

Character	Description
A	Alphabetical characters. For example, ASCII characters a to z and A to Z.
D	Digits 0 to 9. The data masking transformation returns an "X" for characters other than digits 0 to 9.
N	Alphanumeric characters. For example, ASCII characters a to z, A to Z, and 0-9.
X	Any character. For example, alphanumeric or symbol.
+	No masking.
R	Remaining characters. R specifies that the remaining characters in the string can be any character type. R must appear as the last character of the mask.

For example, a department name has the following format:

```
nnn-<department_name>
```

You can configure a mask to force the first three characters to be numeric, the department name to be alphabetic, and the dash to remain in the output. Configure the following mask format:

```
DDD+AAAAAAAAAAAAAAAA
```

The Data Masking transformation replaces the first three characters with numeric characters. It does not replace the fourth character. The Data Masking transformation replaces the remaining characters with alphabetical characters.

If you do not define a mask format, the Data Masking transformation replaces each source character with any character. If the mask format is longer than the input string, the Data Masking transformation ignores the extra characters in the mask format. If the mask format is shorter than the source string, the Data Masking transformation masks the remaining characters with format R.

Note: You cannot configure a mask format with the range option.

Source String Characters

Source string characters are source characters that you choose to mask or not mask. The position of the characters in the source string does not matter. The source characters are case sensitive.

You can configure any number of characters. When Characters is blank, the Data Masking transformation replaces all the source characters in the column.

Select one of the following options for source string characters:

Mask Only

The Data Masking transformation masks characters in the source that you configure as source string characters. For example, if you enter the characters A, B, and c, the Data Masking transformation replaces A, B, or c with a different character when the character occurs in source data. A source character that is not an A, B, or c does not change. The mask is case sensitive.

Mask All Except

Masks all characters except the source string characters that occur in the source string. For example, if you enter the filter source character "-" and select Mask All Except, the Data Masking transformation does not replace the "-" character when it occurs in the source data. The rest of the source characters change.

Source String Example

A source file has a column named Dependents. The Dependents column contains more than one name separated by commas. You need to mask the Dependents column and keep the comma in the test data to delimit the names.

For the Dependents column, select Source String Characters. Choose Don't Mask and enter “,” as the source character to skip. Do not enter quotes.

The Data Masking transformation replaces all the characters in the source string except for the comma.

Result String Replacement Characters

Result string replacement characters are characters you choose as substitute characters in the masked data. When you configure result string replacement characters, the Data Masking transformation replaces characters in the source string with the result string replacement characters. To avoid generating the same output for different input values, configure a wide range of substitute characters, or mask only a few source characters. The position of each character in the string does not matter.

Select one of the following options for result string replacement characters:

Use Only

Mask the source with only the characters you define as result string replacement characters. For example, if you enter the characters A, B, and c, the Data Masking transformation replaces every character in the source column with an A, B, or c. The word “horse” might be replaced with “BAcBA.”

Use All Except

Mask the source with any characters except the characters you define as result string replacement characters. For example, if you enter A, B, and c result string replacement characters, the masked data never has the characters A, B, or c.

Result String Replacement Characters Example

To replace all commas in the Dependents column with semicolons, complete the following tasks:

1. Configure the comma as a source string character and select Mask Only.
The Data Masking transformation masks only the comma when it occurs in the Dependents column.
2. Configure the semicolon as a result string replacement character and select Use Only.
The Data Masking transformation replaces each comma in the Dependents column with a semicolon.

Range

Define a range for numeric, date, or string data. When you define a range for numeric or date values the Data Masking transformation masks the source data with a value between the minimum and maximum values. When you configure a range for a string, you configure a range of string lengths.

String Range

When you configure random string masking, the Data Masking transformation generates strings that vary in length from the length of the source string. Optionally, you can configure a minimum and maximum string width. The values you enter as the maximum or minimum width must be positive integers. Each width must be less than or equal to the port precision.

Numeric Range

Set the minimum and maximum values for a numeric column. The maximum value must be less than or equal to the port precision. The default range is from one to the port precision length.

Date Range

Set minimum and maximum values for a datetime value. The minimum and maximum fields contain the default minimum and maximum dates. The default datetime format is MM/DD/YYYY HH24:MI:SS. The maximum datetime must be later than the minimum datetime.

Blurring

Blurring creates an output value within a fixed or percent variance from the source data value. Configure blurring to return a random value that is close to the original value. You can blur numeric and date values.

Blurring Numeric Values

Select a fixed or percent variance to blur a numeric source value. The low blurring value is a variance below the source value. The high blurring value is a variance above the source value. The low and high values must be greater than or equal to zero. When the Data Masking transformation returns masked data, the numeric data is within the range that you define.

The following table describes the masking results for blurring range values when the input source value is 66:

Blurring Type	Low	High	Result
Fixed	0	10	Between 66 and 76
Fixed	10	0	Between 56 and 66
Fixed	10	10	Between 56 and 76
Percent	0	50	Between 66 and 99
Percent	50	0	Between 33 and 66
Percent	50	50	Between 33 and 99

Blurring Date Values

Mask a date as a variance of the source date by configuring blurring. Select a unit of the date to apply the variance to. You can select the year, month, day, or hour. Enter the low and high bounds to define a variance above and below the unit in the source date. The Data Masking transformation applies the variance and returns a date that is within the variance.

For example, to restrict the masked date to a date within two years of the source date, select year as the unit. Enter two as the low and high bound. If a source date is 02/02/2006, the Data Masking transformation returns a date between 02/02/2004 and 02/02/2008.

By default, the blur unit is year.

Expression Masking

Expression masking applies an expression to a port to change the data or create new data. When you configure expression masking, create an expression in the Expression Editor. Select input and output ports, functions, variables, and operators to build expressions.

You can concatenate data from multiple ports to create a value for another port. For example, you need to create a login name. The source has first name and last name columns. Mask the first and last name from lookup files. In the Data Masking transformation, create another port called Login. For the Login port, configure an expression to concatenate the first letter of the first name with the last name:

```
SUBSTR (FIRSTNM, 1, 1) || LASTNM
```

When you configure expression masking for a port, the port name appears as the expression by default. To access the Expression Editor, click the open button. The Expression Editor displays input ports and the output ports which are not configured for expression masking. You cannot use the output from an expression as input to another expression. If you manually add the output port name to the expression, you might get unexpected results.

Select functions, ports, variables, and operators from the point-and-click interface to minimize errors when you build expressions.

When you create an expression, verify that the expression returns a value that matches the port datatype. The Data Masking transformation returns zero if the data type of the expression port is numeric and the data type of the expression is not the same. The Data Masking transformation returns null values if the data type of the expression port is a string and the data type of the expression is not the same.

Repeatable Expression Masking

Configure repeatable expression masking when a source column occurs in more than one table and you need to mask the column from each table with the same value.

When you configure repeatable expression masking, the Data Masking transformation saves the results of an expression in a storage table. If the column occurs in another source table, the Data Masking transformation returns the masked value from the storage table instead of from the expression.

Dictionary Name

When you configure repeatable expression masking you must enter a dictionary name. The dictionary name is a key that allows multiple Data Masking transformations to generate the same masked values from the same source values. Define the same dictionary name in each Data Masking transformation. The dictionary name can be any text.

Storage Table

The storage table contains the results of repeatable expression masking between sessions. A storage table row contains the source column and a masked value pair. The storage table for expression masking is a separate table from the storage table for substitution masking.

Each time the Data Masking transformation masks a value with a repeatable expression, it searches the storage table by dictionary name, locale, column name and input value. If it finds a row in the storage table, it returns the masked value from the storage table. If the Data Masking transformation does not find a row, it generates a masked value from the expression for the column.

You need to encrypt storage tables for expression masking when you have unencrypted data in the storage and use the same dictionary name as key.

Encrypting Storage Tables for Expression Masking

You can use transformation language encoding functions to encrypt storage tables. You need to encrypt storage tables when you have enabled storage encryption.

1. Create a mapping with the IDM_EXPRESSION_STORAGE storage table as source.
2. Create a Data Masking transformation.
3. Apply the expression masking technique on the masked value ports.
4. Use the following expression on the MASKEDVALUE port:

```
Enc_Base64(AES_Encrypt(MASKEDVALUE, Key))
```

5. Link the ports to the target.

Example

For example, an Employees table contains the following columns:

```
FirstName  
LastName  
LoginID
```

In the Data Masking transformation, mask LoginID with an expression that combines FirstName and LastName. Configure the expression mask to be repeatable. Enter a dictionary name as a key for repeatable masking.

The Computer_Users table contains a LoginID, but no FirstName or LastName columns:

```
Dept  
LoginID  
Password
```

To mask the LoginID in Computer_Users with the same LoginID as Employees, configure expression masking for the LoginID column. Enable repeatable masking and enter the same dictionary name that you defined for the LoginID Employees table. The Integration Service retrieves the LoginID values from the storage table.

Create a default expression to use when the Integration Service cannot find a row in the storage table for LoginID. The Computer_Users table does not have the FirstName or LastName columns, so the expression creates a less meaningful LoginID.

Storage Table Scripts

Informatica provides scripts that you can run to create the storage table. The scripts are in the following location:

```
<PowerCenter installation directory>\client\bin\Extensions\DataMasking
```

The directory contains a script for Sybase, Microsoft SQL Server, IBM DB2, and Oracle databases. Each script is named <Expression_<database type>.

Rules and Guidelines for Expression Masking

Use the following rules and guidelines for expression masking:

- You cannot use the output from an expression as input to another expression. If you manually add the output port name to the expression, you might get unexpected results.
- Use the point-and-click method to build expressions. Select functions, ports, variables, and operators from the point-and-click interface to minimize errors when you build expressions.
- If the Data Masking transformation is configured for repeatable masking, and the storage table does not exist, the Integration Service substitutes the source data with default values.

RELATED TOPICS:

- [“Using the Expression Editor” on page 32](#)

Format Preserving Encryption

Encryption masking applies encryption algorithms to mask source data.

Mask string data types with format preserving encryption.

You can choose to preserve the format and length of the source data or the length of the source data. You can also choose to change the format and length of the source data after encryption.

You can choose characters that you do not want to encrypt.

After you encrypt the source data, you can also decrypt it to get back the original data. To decrypt the data, you must create and run a mapping that uses the same encryption technique with the same pass phrase that you used to encrypt the source data. Set the mode to Decryption.

Note: If the source data contains UTF-8 four byte characters, you cannot use encryption to mask the data.

Select one of the following encryption techniques:

Preserve Format and Metadata

Use the Preserve Format and Metadata encryption option to preserve the format and the length of the source data. When you choose to preserve format and metadata, all uppercase characters are replaced with uppercase characters, lowercase characters are replaced with lowercase characters, numbers are replaced with numbers, and special characters are replaced with special characters after encryption. For example, an email address `Abc123@xyz.com` might become `Mpz849#dje!kuw`. In this example, if you configure "@" and "." characters as Do Not Encrypt Characters, the email might become `Mpz849@dje.kuw`.

Preserve Metadata

Use the Preserve Metadata encryption option to preserve the length of the source data. When you choose to preserve metadata, the length of the data remains the same after encryption. For example, a first name `Alexander` might become `jl6#HB91v`, where the length remains the same as in the source data.

Change Metadata

Use the Change Metadata encryption option to change the length of the source data after encryption. When you choose to change metadata, the encrypted data does not retain the length and format of the source data. For example, a city name `London` might become `Xuep@8f5, fmch529, or 6ky#ke33h*we`.

Note: Before you use the Change Metadata encryption option, you must change the precision of the column you want to apply encryption on in the database.

Use the following formula to calculate the precision and round up the value to the next higher integer:

$$\text{Required Precision} = (1.33 * \text{Original Precision}) + 24$$

After you change the column precision in the database, you must update the column precision in the mapping. To update the column precision you can either reimport the metadata from the updated database, or manually change the column precision in each transformation in the mapping.

Special Mask Formats

The following types of masks retain the format of the original data:

- Social Security numbers
- Credit card numbers
- Phone numbers
- URL addresses
- Email addresses
- IP addresses
- Social Insurance numbers

The Data Masking transformation replaces sensitive data with masked values in a realistic format. For example, when you mask an SSN, the Data Masking transformation returns an SSN that is in the correct format but is not valid.

When the source data format or datatype is invalid for a mask, the Integration Service applies a default mask to the data. The Integration Service applies masked values from the default value file. You can edit the default value file to change the default values.

RELATED TOPICS:

- [“Default Value File” on page 149](#)

Social Security Number Masking

The Data Masking transformation generates a Social Security Number that is not valid based on the latest High Group List from the Social Security Administration. The High Group List contains valid numbers that the Social Security Administration has issued. The Data Masking transformation accesses the latest High Group List from the following location:

```
<Installation Directory>\infa_shared\SrcFiles\highgroup.txt
```

The Data Masking transformation generates SSN numbers that are not on the High Group List. The Social Security Administration updates the High Group List every month. Download the latest version of the list from the following location:

```
http://www.socialsecurity.gov/employer/ssns/highgroup.txt
```

Social Security Number Format

The Data Masking transformation accepts any SSN format that contains nine digits. The digits can be delimited by any set of characters. For example, the Data Masking transformation accepts the following format: `+=54-*9944$#789-,* ()`.

Area Code Requirement

The Data Masking transformation returns a Social Security Number that is not valid with the same format as the source. The first three digits of the SSN define the area code. The Data Masking transformation does not mask the area code. It masks the group number and serial number. The source SSN must contain a valid area code. The Data Masking transformation locates the area code on the High Group List and determines a range

of unused numbers that it can apply as masked data. If the SSN is not valid, the Data Masking transformation does not mask the source data.

Repeatable Social Security Number Masking

The Data Masking transformation returns deterministic Social Security numbers with repeatable masking. The Data Masking transformation cannot return all unique Social Security numbers because it cannot return valid Social Security numbers that the Social Security Administration has issued.

Credit Card Number Masking

Credit card masking applies a built-in mask format to disguise credit card numbers. You can input multiple credit card number formats. Optionally, you can replace the credit card issuer.

The PowerCenter Integration Service generates a logically valid credit card number when it masks a valid credit card number. The length of the source credit card number must be from 13 through 19 digits. The input credit card number must have a valid checksum based on credit card industry rules.

The source credit card number can contain numbers, spaces, and hyphens. If the credit card has incorrect characters or is the wrong length, the Integration Service writes an error to the session log. The PowerCenter Integration Service applies a default credit card number mask when the source data is not valid.

You can configure credit card masking to keep or replace the first six digits of a credit card number. Together, these digits identify the credit card issuer. If you replace the credit card issuer, you can specify another credit card issuer. You can specify the following credit card issuers:

- American Express
- Discover
- JCB
- MasterCard
- Visa
- Any

If you select Any, the Data Masking transformation returns a combination of all the credit card issuers. If you mask the credit card issuer, the Data Masking transformation can return nonunique values.

For example, the CUSTOMER table has the following credit card numbers:

```
2131 0000 0000 0008
5500 0000 0000 0004
6334 0000 0000 0004
```

If you select a single credit card issuer, the credit card numbers share all but the last digit. To generate valid credit card numbers, the Data Masking transformation sets the last digit of each credit card to the same value.

Phone Number Masking

The Data Masking transformation masks a phone number without changing the format of the original phone number. For example, the Data Masking transformation can mask the phone number (408)382 0658 as (607)256 3106.

The source data can contain numbers, spaces, hyphens, and parentheses. The Integration Service does not mask alphabetic or special characters.

The Data Masking transformation can mask string, integer, and bigint data.

Email Address Masking

Use the Data Masking transformation to mask the email address that contains string value. The Data Masking transformation can mask an email address with random ASCII characters or replace the email address with a realistic email address.

You can apply the following types of masking with email address:

Standard email masking

The Data Masking transformation returns random ASCII characters when it masks an email address. For example, the Data Masking transformation can mask Georgesmith@yahoo.com as KtrlupQAPyk@vdSKh.BIC. Default is standard.

Advanced email masking

The Data Masking transformation masks the email address with another realistic email address derived from the transformation output ports or dictionary columns.

Advanced Email Masking

With advanced email masking, you can mask the email address with another realistic email address. The Data Masking transformation creates the email address from the dictionary columns or from the transformation output ports.

You can create the local part in the email address from mapping output ports. Or you can create the local part in the email address from relational table or flat file columns.

The Data Masking transformation can create the domain name for the email address from a constant value or from a random value in the domain dictionary.

You can create an advanced email masking based on the following options:

Email Address Based on a Mapping

You can create an email address based on the Data Masking transformation output ports. Select the transformation output ports for the first name and the last name column. The Data Masking transformation masks the first name, the last name, or both names based on the values you specify for the first and last name length.

Email Address Based on a Dictionary

You can create an email address based on the columns from a dictionary. The dictionary can be a relational table or flat file.

Select the dictionary columns for the first name and the last name. The Data Masking transformation masks the first name, the last name, or both names based on the values you specify for the first and last name length. You can also configure an expression to mask the email address. If you configure an expression, then the Data Masking transformation does not mask based on the length of the first name or last name column.

Configuration Parameters for an Advanced Email Address Masking Type

Specify configuration parameters when you configure advanced email address masking.

You can specify the following configuration parameters:

Delimiter

You can select a delimiter, such as a dot, hyphen, or underscore, to separate the first name and last name in the email address. If you do not want to separate the first name and last name in the email address, leave the delimiter as blank.

FirstName Column

Select a Data Masking transformation output port or a dictionary column to mask the first name in the email address.

LastName Column

Select a Data Masking transformation output port or a dictionary column to mask the last name in the email address.

Length for the FirstName or LastName columns

Restricts the character length to mask for the first name and the last name columns. For example, the input data is Timothy for the first name and Smith for the last name. Select 5 as the length of the first name column. Select 1 as the length of the last name column with a dot as the delimiter. The Data Masking transformation generates the following email address:

```
timot.s@<domain_name>
```

DomainName

You can use a constant value, such as gmail.com, for the domain name. Or, you can specify another dictionary file that contains a list of domain names. The domain dictionary can be a flat file or a relational table.

Expressions for the Advanced Email Address Masking Type

You can use expression functions when you select dictionary columns to create an email address.

To configure an expression for the advanced email masking type, choose columns to form the email address from the dictionary. You can then configure the expression with the dictionary columns, the transformation ports, or with both the dictionary columns and the transformation ports.

The dictionary ports are listed in the following syntax in the Expression Editor:

```
<Input string mapping port>_Dictionary_<dictionary column name>
```

Social Insurance Number Masking

The Data Masking transformation masks a Social Insurance number that is nine digits. The digits can be delimited by any set of characters.

If the number contains no delimiters, the masked number contains no delimiters. Otherwise the masked number has the following format:

```
xxx-xxx-xxx
```

SIN Start Digit

You can define the first digit of the masked SIN.

Enable **Start Digit** and enter the digit. The Data Masking transformation creates masked SIN numbers that start with the number that you enter.

Repeatable SIN Numbers

You can configure the Data Masking transformation to return repeatable SIN values. When you configure a port for repeatable SIN masking, the Data Masking transformation returns deterministic masked data each time the source SIN value and seed value are the same.

To return repeatable SIN numbers, enable **Repeatable Values** and enter a seed number. The Data Masking transformation returns unique values for each SIN.

IP Address Masking

The Data Masking transformation masks an IP address as another IP address by splitting it into four numbers, separated by a period. The first number is the network. The Data Masking transformation masks the network number within the network range.

The Data Masking transformation masks a Class A IP address as a Class A IP Address and a 10.x.x.x address as a 10.x.x.x address. The Data Masking transformation does not mask the class and private network address. For example, the Data Masking transformation can mask 11.12.23.34 as 75.32.42.52. and 10.23.24.32 as 10.61.74.84.

Note: When you mask many IP addresses, the Data Masking transformation can return nonunique values because it does not mask the class or private network of the IP addresses.

URL Address Masking

The Data Masking transformation parses a URL by searching for the '://' string and parsing the substring to the right of it. The source URL must contain the '://' string. The source URL can contain numbers and alphabetic characters.

The Data Masking transformation does not mask the protocol of the URL. For example, if the URL is `http://www.yahoo.com`, the Data Masking transformation can return `http://MgL.aHjCa.VsD/`. The Data Masking transformation can generate a URL that is not valid.

Note: The Data Masking transformation always returns ASCII characters for a URL.

Default Value File

When the source data format or datatype is not valid for a mask, the Integration Service applies a default mask to the data. The Integration Service applies masked values from the default value file. You can edit the default value file to change the default values.

The default value file is an XML file in the following location:

```
<PowerCenter Installation Directory>\infa_shared\SrcFiles\defaultValue.xml
```

The defaultValue.xml file contains the following name-value pairs:

```
<?xml version="1.0" standalone="yes" ?>
<defaultValue
default_char = "X"
default_digit = "9"
default_date = "11/11/1111 00:00:00"
default_email = "abc@xyz.com"
default_ip = "99.99.9.999"
default_url = "http://www.xyz.com"
default_phone = "9999999999"
default_ssn = "999-99-9999"
default_cc = "9999 9999 9999 9999"
default_seed = "500"
/>
```

Data Masking Transformation Session Properties

You can configure Data Masking transformation session properties to increase performance.

Configure the following session properties:

Cache Size

The size of the dictionary cache in main memory. Increase the memory size in order to improve performance. Minimum recommended size is 32 MB for 100,000 records. Default is 8 MB.

Cache Directory

The location of the dictionary cache. You must have write permissions for the directory. Default is \$PMCacheDir.

Shared Storage Table

Enables sharing of the storage table between Data Masking transformation instances. Enable Shared Storage Table when two Data Masking transformation instances use the same dictionary column for the database connection, seed value, and locale. You can also enable the shared storage table when two ports in the same Data Masking transformation use the same dictionary column for the connection, seed, and locale. Disable the shared storage table when Data Masking transformations or ports do not share the dictionary column. Default is disabled.

Storage Commit Interval

The number of rows to commit at a time to the storage table. Increase the value to increase performance. Configure the commit interval when you do not configure the shared storage table. Default is 100,000.

Encrypt Storage

Encrypts storage tables, such as `IDM_SUBSTITUTION_STORAGE` and `IDM_EXPRESSION_STORAGE`. Verify that you have encrypted data in storage tables before you enable the encrypt storage property. Clear this option if you do not want to encrypt the storage tables. Default is disabled.

Storage Encryption Key

The Data Masking transformation encrypts the storage based on the storage encryption key. Use the same encryption key for each session run of the same Data Masking transformation instance.

Use SoftHSM

Required for format preserving encryption. Choose whether to use SoftHSM during encryption. SoftHSM is more secure, but you might notice a difference in performance.

Passphrase

Required for format preserving encryption. The passphrase generates a key to encrypt or decrypt data. You can choose to enter an encrypted passphrase or a passphrase in plain text. Use the site key to encrypt the passphrase and enter the encrypted value.

Passphrase is Encrypted

For mappings that you create in the Designer tool, you can choose to enter an encrypted passphrase or a passphrase in plain text. For workflows that you generate in Test Data Management, the option is always Yes.

Mode

Required for format preserving encryption. Determines whether the Data Masking transformation performs encryption or decryption of the data. Set the value to Encryption to encrypt source data. To decrypt the masked data and return the original source data, run a mapping with the same encryption technique configuration and passphrase, with the mode set to Decryption.

Rules and Guidelines for Data Masking Transformations

Use the following rules and guidelines when you configure a Data Masking transformation:

- The Data Masking transformation does not mask null values. If the source data contains null values, the Data Masking transformation returns null values. To replace null values, add an upstream transformation that allows user-defined default values for input ports.
- When the source data format or datatype is not valid for a mask, the Integration Service applies a default mask to the data. The Integration Service applies masked values from a default values file.
- The Data Masking transformation returns an invalid Social Security number with the same format and area code as the source. If the Social Security Administration has issued more than half of the numbers for an area, the Data Masking transformation might not be able to return unique invalid Social Security numbers with key masking.

CHAPTER 6

Data Masking Examples

This chapter includes the following topics:

- [Name and Address Lookup Files, 151](#)
- [Substituting Data with the Lookup Transformation, 151](#)
- [Masking Data with an Expression Transformation, 154](#)

Name and Address Lookup Files

The Data Masking installation includes several flat files that contain names, addresses, and company names for masking data. You can configure a Lookup transformation to retrieve random first names, last names, and addresses from these files.

When you install the Data Masking server component, the installer places the following files in the `server\infa_shared\LkpFiles` folder:

- **Address.dic.** Flat file of addresses. Each record has a serial number, street, city, state, zip code, and country.
- **Company_names.dic.** Flat file of company names. Each record has a serial number and company name.
- **Firstnames.dic.** Flat file of first names. Each record has a serial number, name, and gender code.
- **Surnames.dic.** Flat file of last names. Each record has a serial number and a last name.

Substituting Data with the Lookup Transformation

You can substitute a column of data with similar but unrelated data. Substitution is an effective way to mask sensitive data with a realistic looking data.

The following example shows how to configure multiple Lookup transformations to retrieve test data and substitute it for source data. Create a Data Masking mapping to mask the sensitive fields in CUSTOMERS_PROD table.

The example includes the following types of masking:

- Name and address substitution from Lookup tables
- Key masking
- Blurring

- Special mask formats

Note: This example is the M_CUSTOMERS_MASKING.xml mapping that you can import to your repository from the `client\samples` folder.

A customer database table called Customers_Prod contains sensitive data. You want to use the customer data in a test scenario, but you want to maintain security. You mask the data in each column and write the test data to a target table called Customers_Test.

The Customers_Prod table contains the following columns:

Column	Datatype
CustID	Integer
FullName	String
Address	String
Phone	String
Fax	String
CreatedDate	Date
Email	String
SSN	String
CreditCard	String

You can create a mapping that looks up substitute values in dictionary files. The Data Masking transformation masks the customer data with values from the dictionary files. The files include a first name file, a surname file, and an address file.

The following table lists the files that are located in the `server\infa_shared\LkpFiles` folder:

File	Number of Records	Fields	Description
Firstnames.dic	21,000	SNO, Gender, Firstname	Alphabetical list of first names. The serial number goes from 1 to 21,000. Gender indicates whether the name is male or female.
Surnames.dic	81,000	SNO, Surname	Alphabetical list of last names. The serial number goes from 1 to 81,000.
Address.dic	13,000	SNO, Street, City, State, Zip, Country	List of complete addresses. The serial number goes from 1 to 13,000.

Note: Informatica includes the gender column in the Firstnames.dic file so you can create separate lookup source files by gender. You can use the gender column in a lookup condition if you need to mask with a male name and a female name with a female name.

The following figure shows the mapping that you can import:

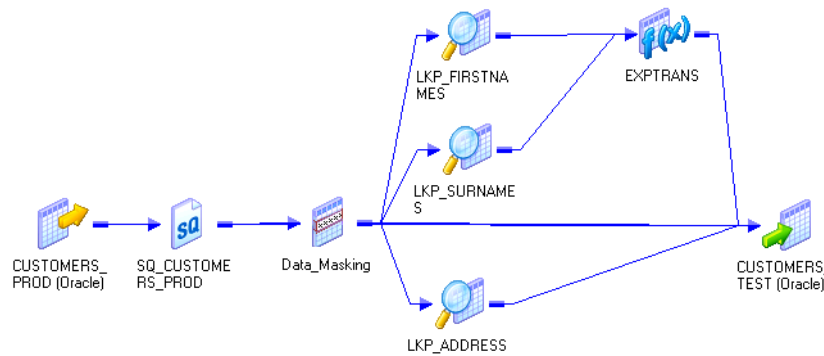

The mapping has the following transformations along with a source and target:

- Source Qualifier.** Passes customer data to the Data Masking transformation. It passes the CustID column to multiple ports in the transformation:
 - **CustID.** Customer number.
 - **Randid1.** Random number generator for first name lookups.
 - **Randid2.** Random number generator for last name lookups.
 - **Randid3.** Random number generator for address lookups.
- Data Masking transformation.** Creates random numbers to look up the replacement first name, last name, and address. Applies special mask formats to the phone number, fax, email address, and credit card number. The Data Masking transformation masks the following columns:

Input Port	Masking Type	Masking Rules	Description	Output Destination
CustID	Key	Seed = 934	CustID is the primary key column. It must be masked with a random number that is repeatable and deterministic.	Customers_Test
Randid1	Random	Range Minimum = 0 Maximum = 21000	Random number for first name lookup in the LKUP_Firstnames transformation.	LKUP_Firstnames
Randid2	Random	Range Minimum = 0 Maximum = 13000	Random number for last name lookup in the LKUP_Surnames transformation.	LKUP_Surnames
Randid3	Random	Range Minimum = 0 Maximum = 81000	Random number for address lookup in the LKUP_Address transformation.	LKUP_Address
Phone	Phone	-	Phone number has the same format as the source phone number.	Customers_Test

Input Port	Masking Type	Masking Rules	Description	Output Destination
Fax	Phone	-	Phone number has the same format as the source phone number.	Customers_Test
CreatedDate	Random	Blurring Unit = Year Low Bound = 1 High Bound = 1	Random date that is within a year of the source year.	Customers_Test
Email	Email Address	-	Email address has the same format as the original.	Customers_Test
SSN	SSN	-	SSN is not in the highgroup.txt file.	Customers_Test
CreditCard	Credit Card	-	Credit card has the same first six digits as the source and has a valid checksum.	Customers_Test

- **LKUP_Firstnames.** Performs a flat file lookup on Firstnames.dic. The transformation retrieves the record with the serial number equal to the random number Randid1. The lookup condition is:

```
SNO = out_RANDID1
```

The LKUP_Firstnames transformation passes the masked first name to the Exptrans Expression transformation.

- **LKUP_Surnames.** Performs a flat file lookup on the Surnames.dic file. It retrieves the record with the serial number equal to Randid2. The LKUP_Firstnames transformation passes a masked last name to the Exptrans Expression transformation.
- **Exptrans.** Combines the first and last name and returns a full name. The Expression transformation passes the full name to the Customers_Test target.

The Expression to combine the first and last names is:

```
FIRSTNAME || ' ' || SURNAME
```

- **LKUP_Address.** Performs a flat file lookup on the Address.dic file. It retrieves the address record with the serial number equal to Randid3. The Lookup transformation passes the columns in the address to the target.

You can use the Customer_Test table in a test environment.

Masking Data with an Expression Transformation

Use the Expression transformation with the Data Masking transformation to maintain a relationship between two columns after you mask one of the columns.

For example, when you mask account information that contains start and end dates for insurance policies, you want to maintain the policy length in each masked record. Use a Data Masking transformation to mask all data except the end date. Use an Expression transformation to calculate the policy length and add the policy length to the masked start date.

This example includes the following types of masking:

- Key
- Date blurring
- Number blurring
- Mask formatting

Note: This example is the M_CUSTOMER_ACCOUNTS_MASKING.xml mapping that you can import to your repository from the `client\samples` folder.

A customer database table called Customers_Prod contains sensitive data. You mask the data in each column and write the test data to a target table called Customers_Test.

Mask the following Customer_Accounts_Prod columns:

Column	Datatype
AcctID	String
CustID	Integer
Balance	Double
StartDate	Datetime
EndDate	Datetime

The following figure shows the mapping that you can import:

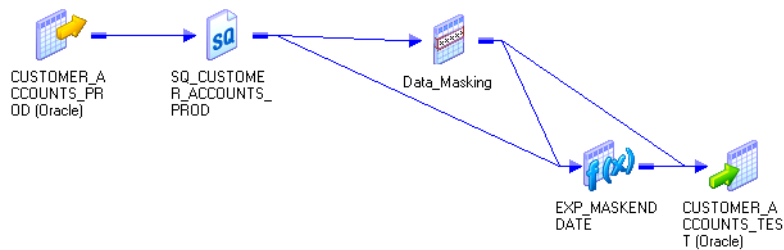

The mapping has following transformations along with a source and target:

- **Source Qualifier.** Passes the AcctID, CustID, Balance, and Start_Date to the Data Masking transformation. It passes Start_Date and End_Date columns to an Expression transformation.
- **Data Masking transformation.** Masks all the columns except End_Date. The Data Masking transformation passes the masked columns to the target. It passes the policy start date, end date, and the masked start date to the Expression transformation.

The Data Masking transformation masks the following columns:

Input Port	Masking Type	Masking Rules	Description	Output Destination
AcctID	Random	Mask format AA+DDDDD Result String Replacement Characters ABCDEFGHIJKLMNO PQRSTUVWXYZ	The first two characters are uppercase alphabetic characters. The third character is a dash and is not masked. The last five characters are numbers.	Customer_Account_Test target
CustID	Key	Seed = 934	The seed is 934. The CustID mask is deterministic.	Customer_Account_Test target
Balance	Random	Blurring Percent Low bound = 10 High bound = 10	The masked balance is within ten percent of the source balance.	Customer_Account_Test target
Start_Date	Random	Blurring Unit = Year Low Bound = 2 High Bound = 2	The masked start_date is within two years of the source date.	Customer_Account_Test target Exp_MaskEndDatetransform ation

- **Expression transformation.** Calculates the masked end date. It calculates the time between the start and end dates. It adds the time to the masked start date to determine the masked end date.

The expressions to generate the masked end date are:

```
DIFF = DATE_DIFF(END_DATE, START_DATE, 'DD')
out_END_DATE = ADD_TO_DATE(out_START_DATE, 'DD', DIFF)
```

The Expression transformation passes out_END_DATE to the target.

CHAPTER 7

Expression Transformation

This chapter includes the following topics:

- [Expression Transformation Overview, 157](#)
- [Expression Transformation Components, 157](#)
- [Configuring Ports, 158](#)
- [Creating an Expression Transformation, 159](#)

Expression Transformation Overview

Use the Expression transformation to calculate values in a single row. For example, you might need to adjust employee salaries, concatenate first and last names, or convert strings to numbers. You can also use the Expression transformation to test conditional statements before you pass the results to a target or other transformations. The Expression transformation is a passive transformation.

Use the Expression transformation to perform non-aggregate calculations. To perform calculations involving multiple rows, such as sums or averages, use the Aggregator transformation.

The following figure shows a simple mapping with an Expression transformation used to concatenate the first and last names of employees from the EMPLOYEES table:

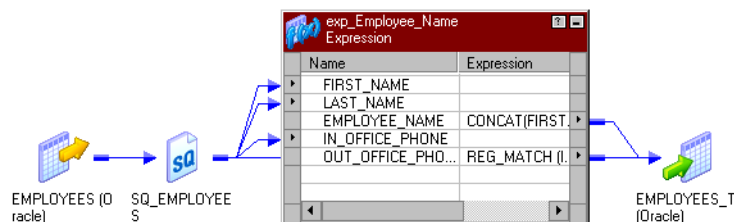

You can evaluate expressions that you configure in the Expression Editor.

Expression Transformation Components

You can create an Expression transformation in the Transformation Developer or the Mapping Designer.

An Expression transformation contains the following tabs:

- **Transformation.** Enter the name and description of the transformation. The naming convention for an Expression transformation is `EXP_TransformationName`. You can also make the transformation reusable.
- **Ports.** Create and configure ports.
- **Properties.** Configure the tracing level to determine the amount of transaction detail reported in the session log file.
- **Metadata Extensions.** Specify the extension name, datatype, precision, and value. You can also create reusable metadata extensions.

Configuring Ports

You can create and modify ports on the Ports tab.

Configure the following components on the Ports tab:

- **Port name.** Name of the port.
- **Datatype, precision, and scale.** Configure the datatype and set the precision and scale for each port.
- **Port type.** A port can be input, output, input/output, or variable. The input ports receive data and output ports pass data. The input/output ports pass data unchanged. Variable ports store data temporarily and can store values across the rows.
- **Expression.** Use the Expression Editor to enter expressions. Expressions use the transformation language, which includes SQL-like functions, to perform calculations.
- **Default values and description.** Set default value for ports and add description.

Calculating Values

To calculate values for a single row using the Expression transformation, you must include the following ports:

- **Input or input/output ports.** Provides values used in a calculation. For example, if you need to calculate the total price for an order, create two input or input/output ports. One port provides the unit price and the other provides the quantity ordered.
- **Output ports.** Provides the return value of the expression. You enter the expression as a configuration option for the output port. You can also configure a default value for each port.

You can enter multiple expressions in a single Expression transformation by creating an expression for each output port. For example, you might want to calculate different types of withholding taxes from each employee paycheck, such as local and federal income tax, Social Security and Medicare. Since all of these calculations require the employee salary, the withholding category, and may require the corresponding tax rate, you can create input/output ports for the salary and withholding category and a separate output port for each calculation.

Creating an Expression Transformation

Use the following procedure to create an Expression transformation:

1. In the Mapping Designer, open a mapping.
2. Click Transformation > Create. Select Expression transformation.
3. Enter a name and click Done.
4. Select and drag the ports from the source qualifier or other transformations to add to the Expression transformation.

You can also open the transformation and create ports manually.

5. Double-click on the title bar and click on Ports tab. You can create output and variable ports within the transformation.
6. Assign the port datatype, precision, and scale to match the expression return value.
7. In the Expression section of an output or variable port, open the Expression Editor.
8. Enter an expression.
9. Click Validate to verify the expression syntax.
10. To reflect the latest changes from the expression condition in the test expression section in the right pane, click Refresh.
11. In the right pane, enter sample values for the input ports used within the expression.
12. To evaluate the expression, click Evaluate.
13. Click OK.
14. Create reusable transformations on the Transformation tab.
Note: After you make the transformation reusable, you cannot copy ports from the source qualifier or other transformations. You *can* create ports manually within the transformation.
15. Configure the tracing level on the Properties tab.
16. Add metadata extensions on the Metadata Extensions tab.
17. Click OK.
18. Connect the output ports to a downstream transformation or target.

CHAPTER 8

External Procedure Transformation

This chapter includes the following topics:

- [External Procedure Transformation Overview, 160](#)
- [Configuring External Procedure Transformation Properties, 162](#)
- [Developing COM Procedures, 164](#)
- [Developing Informatica External Procedures, 171](#)
- [Distributing External Procedures, 179](#)
- [Development Notes, 180](#)
- [Service Process Variables in Initialization Properties, 187](#)
- [External Procedure Interfaces, 187](#)

External Procedure Transformation Overview

External Procedure transformations operate in conjunction with procedures you create outside of the Designer interface to extend PowerCenter functionality.

Although the standard transformations provide you with a wide range of options, there are occasions when you might want to extend the functionality provided with PowerCenter. For example, the range of standard transformations, such as Expression and Filter transformations, may not provide the functionality you need. If you are an experienced programmer, you may want to develop complex functions within a dynamic link library (DLL) or UNIX shared library, instead of creating the necessary Expression transformations in a mapping.

To get this kind of extensibility, use the Transformation Exchange (TX) dynamic invocation interface built into PowerCenter. Using TX, you can create an Informatica External Procedure transformation and bind it to an external procedure that you have developed. You can bind External Procedure transformations to two kinds of external procedures:

- COM external procedures (available on Windows only)
- Informatica external procedures (available on Windows, AIX, Linux, and Solaris)

To use TX, you must be an experienced C, C++, or Visual Basic programmer.

Use multi-threaded code in external procedures.

Code Page Compatibility

When the Integration Service runs in ASCII mode, the external procedure can process data in 7-bit ASCII. When the Integration Service runs in Unicode mode, the external procedure can process data that is two-way compatible with the Integration Service code page.

Configure the Integration Service to run in Unicode mode if the external procedure DLL or shared library contains multibyte characters. External procedures must use the same code page as the Integration Service to interpret input strings from the Integration Service and to create output strings that contain multibyte characters.

Configure the Integration Service to run in either ASCII or Unicode mode if the external procedure DLL or shared library contains ASCII characters only.

External Procedures and External Procedure Transformations

There are two components to TX: *external procedures* and *External Procedure transformations*.

An *external procedure* exists separately from the Integration Service. It consists of C, C++, or Visual Basic code written by a user to define a transformation. This code is compiled and linked into a DLL or shared library, which is loaded by the Integration Service at runtime. An external procedure is “bound” to an External Procedure transformation.

An *External Procedure transformation* is created in the Designer. It is an object that resides in the Informatica repository and serves several purposes:

1. It contains the metadata describing the following external procedure. It is through this metadata that the Integration Service knows the “signature” (number and types of parameters, type of return value, if any) of the external procedure.
2. It allows an external procedure to be referenced in a mapping. By adding an instance of an External Procedure transformation to a mapping, you call the external procedure bound to that transformation.
Note: You can create a connected or unconnected External Procedure.
3. When you develop Informatica external procedures, the External Procedure transformation provides the information required to generate Informatica external procedure stubs.

External Procedure Transformation Properties

Create reusable External Procedure transformations in the Transformation Developer, and add instances of the transformation to mappings. You cannot create External Procedure transformations in the Mapping Designer or Maplet Designer.

External Procedure transformations return one or no output rows for each input row.

On the Properties tab of the External Procedure transformation, only enter ASCII characters in the Module/Programmatic Identifier and Procedure Name fields. You cannot enter multibyte characters in these fields. On the Ports tab of the External Procedure transformation, only enter ASCII characters for the port names. You cannot enter multibyte characters for External Procedure transformation port names.

COM Versus Informatica External Procedures

The following table describes the differences between COM and Informatica external procedures:

	COM	Informatica
Technology	Uses COM technology	Uses Informatica proprietary technology
Operating System	Runs on Windows only	Runs on all platforms supported for the Integration Service: Windows, AIX, HP, Linux, Solaris
Language	C, C++, VC++, VB, Perl, VJ++	Only C++

The BankSoft Example

The following sections use an example called BankSoft to illustrate how to develop COM and Informatica procedures. The BankSoft example uses a financial function, FV, to illustrate how to develop and call an external procedure. The FV procedure calculates the future value of an investment based on regular payments and a constant interest rate.

Configuring External Procedure Transformation Properties

Configure transformation properties on the Properties tab.

The following table describes the External Procedure transformation properties:

Property	Description
Type	Type of external procedure. Use the following types: <ul style="list-style-type: none">- COM- Informatica Default is Informatica.
Module/Programmatic Identifier	A module is a base name of the DLL (on Windows) or the shared object (on UNIX) that contains the external procedures. It determines the name of the DLL or shared object on the operating system. Enter ASCII characters only. A programmatic identifier, or ProgID, is the logical name for a class. In the Designer, you refer to COM classes through ProgIDs. Internally, classes are identified by numeric CLSID's. For example: {33B17632-1D9F-11D1-8790-0000C044ACF9} The standard format of a ProgID is <i>Project.Class[.Version]</i> . Enter ASCII characters only.
Procedure Name	Name of the external procedure. Enter ASCII characters only.

Property	Description
Runtime Location	<p>Location that contains the DLL or shared library. Enter a path relative to the Integration Service node that runs the External Procedure session. If you enter \$PMEExtProcDir, then the Integration Service looks in the directory specified by the process variable \$PMEExtProcDir to locate the library.</p> <p>If this property is blank, the Integration Service uses the environment variable defined on the on the Integration Service node to locate the DLL or shared library.</p> <p>You can hard code a path as the Runtime Location. This is not recommended since the path is specific to a single machine only.</p> <p>You must copy all DLLs or shared libraries to the runtime location or to the environment variable defined on the Integration Service node. The Integration Service fails to load the procedure when it cannot locate the DLL, shared library, or a referenced file.</p> <p>Default is \$PMEExtProcDir.</p>
Tracing Level	<p>Amount of transaction detail reported in the session log file. Use the following tracing levels:</p> <ul style="list-style-type: none"> - Terse - Normal - Verbose Initialization - Verbose Data <p>Default is Normal.</p>
Is Partitionable	<p>Indicates if you can create multiple partitions in a pipeline that uses this transformation. Use the following values:</p> <ul style="list-style-type: none"> - No. The transformation cannot be partitioned. The transformation and other transformations in the same pipeline are limited to one partition. - Locally. The transformation can be partitioned, but the Integration Service must run all partitions in the pipeline on the same node. Choose Local when different partitions of the BAPI/RFC transformation must share objects in memory. - Across Grid. The transformation can be partitioned, and the Integration Service can distribute each partition to different nodes. <p>Default is No.</p>
Output is Repeatable	<p>Indicates whether the transformation generates rows in the same order between session runs. The Integration Service can resume a session from the last checkpoint when the output is repeatable and deterministic. Use the following values:</p> <ul style="list-style-type: none"> - Always. The order of the output data is consistent between session runs even if the order of the input data is inconsistent between session runs. - Based on Input Order. The transformation produces repeatable data between session runs when the order of the input data from all input groups is consistent between session runs. If the input data from any input group is not ordered, then the output is not ordered. - Never. The order of the output data is inconsistent between session runs. You cannot configure recovery to resume from the last checkpoint if a transformation does not produce repeatable data. <p>Default is Based on Input Order.</p>
Output is Deterministic	<p>Indicates whether the transformation generates consistent output data between session runs. You must enable this property to perform recovery on sessions that use this transformation.</p> <p>Default is disabled.</p>

Warning: If you configure a transformation as repeatable and deterministic, it is your responsibility to ensure that the data is repeatable and deterministic. If you try to recover a session with transformations that do not

produce the same data between the session and the recovery, the recovery process can result in corrupted data.

The following table describes the environment variables the Integration Service uses to locate the DLL or shared object on the various platforms for the runtime location:

Table 1. Environment Variables

Operating System	Environment Variable
Windows	PATH
AIX	LIBPATH
HPUX	SHLIB_PATH
Linux	LD_LIBRARY_PATH
Solaris	LD_LIBRARY_PATH

Developing COM Procedures

You can develop COM external procedures using Microsoft Visual C++ or Visual Basic. The following sections describe how to create COM external procedures using Visual C++ and how to create COM external procedures using Visual Basic.

Steps for Creating a COM Procedure

To create a COM external procedure, complete the following steps:

1. Using Microsoft Visual C++ or Visual Basic, create a project.
2. Define a class with an *IDispatch* interface.
3. Add a method to the interface. This method is the external procedure that will be invoked from inside the Integration Service.
4. Compile and link the class into a dynamic link library.
5. Register the class in the local Windows registry.
6. Import the COM procedure in the Transformation Developer.
7. Create a mapping with the COM procedure.
8. Create a session using the mapping.

COM External Procedure Server Type

The Integration Service only supports in-process COM servers, which have *Server Type: Dynamic Link Library*. This is done to enhance performance. It is more efficient when processing large amounts of data to process the data in the same process, instead of forwarding it to a separate process on the same machine or a remote machine.

Using Visual C++ to Develop COM Procedures

C++ developers can use Visual C++ version 5.0 or later to develop COM procedures. The first task is to create a project.

RELATED TOPICS:

- [“Distributing External Procedures” on page 179](#)
- [“Wrapper Classes for Pre-Existing C/C++ Libraries or VB Functions” on page 182](#)

Step 1. Create an ATL COM AppWizard Project

1. Launch Visual C++ and click File > New.
2. In the dialog box that appears, select the Projects tab.
3. Enter the project name and location.
In the BankSoft example, you enter *COM_VC_Banksoft* as the project name, and *c:\COM_VC_Banksoft* as the directory.
4. Select the *ATL COM AppWizard* option in the projects list box and click OK.
A wizard used to create COM projects in Visual C++ appears.
5. Set the Server Type to *Dynamic Link Library*, select the *Support MFC* option, and click Finish.
The final page of the wizard appears.
6. Click OK to return to Visual C++.
7. Add a class to the new project.
8. On the next page of the wizard, click the OK button. The Developer Studio creates the basic project files.

Step 2. Add an ATL Object to a Project

1. In the Workspace window, select the Class View tab, right-click the tree item *COM_VC_BankSoft.BSoftFin* classes, and choose *New ATL Object* from the local menu that appears.
2. Highlight the *Objects* item in the left list box and select *Simple Object* from the list of object types.
3. Click Next.
4. In the Short Name field, enter a short name for the class you want to create.
In the BankSoft example, use the name *BSoftFin*, since you are developing a financial function for the fictional company BankSoft. As you type into the Short Name field, the wizard fills in suggested names in the other fields.
5. Enter the programmatic identifier for the class.
In the BankSoft example, change the ProgID (programmatic identifier) field to *COM_VC_BankSoft.BSoftFin*.
A programmatic identifier, or ProgID, is the human-readable name for a class. Internally, classes are identified by numeric CLSID's. For example:

```
{33B17632-1D9F-11D1-8790-0000C044ACF9}
```

The standard format of a ProgID is *Project.Class[.Version]*. In the Designer, you refer to COM classes through ProgIDs.
6. Select the Attributes tab and set the threading model to *Free*, the interface to *Dual*, and the aggregation setting to *No*.
7. Click OK.

Now that you have a basic class definition, you can add a method to it.

Step 3. Add the Required Methods to the Class

1. Return to the Classes View tab of the Workspace Window.
2. Expand the tree view.
For the BankSoft example, you expand *COM_VC_BankSoft*.
3. Right-click the newly-added class.
In the BankSoft example, you right-click the *IBSoftFin* tree item.
4. Click the Add Method menu item and enter the name of the method.
In the BankSoft example, you enter *FV*.
5. In the Parameters field, enter the signature of the method.

For *FV*, enter the following:

```
[in] double Rate,  
[in] long nPeriods,  
[in] double Payment,  
[in] double PresentValue,  
[in] long PaymentType,  
[out, retval] double* FV
```

This signature is expressed in terms of the Microsoft Interface Description Language (MIDL). For a complete description of MIDL, see the MIDL language reference. Note that:

- **[in]** indicates that the parameter is an input parameter.
- **[out]** indicates that the parameter is an output parameter.
- **[out, retval]** indicates that the parameter is the return value of the method.

Also, all [out] parameters are passed by reference. In the BankSoft example, the parameter *FV* is a double.

6. Click OK.
The Developer Studio adds to the project a stub for the method you added.

Step 4. Fill Out the Method Stub with an Implementation

1. In the BankSoft example, return to the Class View tab of the Workspace window and expand the *COM_VC_BankSoft* classes item.
2. Expand the *CBSoftFin* item.
3. Expand the *IBSoftFin* item under the above item.
4. Right-click the *FV* item and choose Go to Definition.
5. Position the cursor in the edit window on the line after the TODO comment and add the following code:

```
double v = pow((1 + Rate), nPeriods);  
*FV = -(  
    (PresentValue * v) +  
    (Payment * (1 + (Rate * PaymentType))) * ((v - 1) / Rate)  
);
```

Since you refer to the *pow* function, you have to add the following preprocessor statement after all other include statements at the beginning of the file:

```
#include <math.h>
```

The final step is to build the DLL. When you build it, you register the COM procedure with the Windows registry.

Step 5. Build the Project

1. Pull down the Build menu.
2. Select Rebuild All.

As Developer Studio builds the project, it generates the following output:

```
-----Configuration: COM_VC_BankSoft - Win32 Debug-----  
  
Performing MIDL step  
Microsoft (R) MIDL Compiler Version 3.01.75  
Copyright (c) Microsoft Corp 1991-1997. All rights reserved.  
Processing .\COM_VC_BankSoft.idl  
COM_VC_BankSoft.idl  
Processing C:\msdev\VC\INCLUDE\oidl.idl  
oidl.idl  
Processing C:\msdev\VC\INCLUDE\objidl.idl  
objidl.idl  
Processing C:\msdev\VC\INCLUDE\unknwn.idl  
unknwn.idl  
Processing C:\msdev\VC\INCLUDE\wtypes.idl  
wtypes.idl  
Processing C:\msdev\VC\INCLUDE\ocidl.idl  
ocidl.idl  
Processing C:\msdev\VC\INCLUDE\oleidl.idl  
oleidl.idl  
Compiling resources...  
Compiling...  
StdAfx.cpp  
Compiling...  
COM_VC_BankSoft.cpp  
BSoftFin.cpp  
Generating Code...  
Linking...  
  
Creating library Debug/COM_VC_BankSoft.lib and object Debug/COM_VC_BankSoft.exp  
Registering ActiveX Control...  
  
RegSvr32: DllRegisterServer in .\Debug\COM_VC_BankSoft.dll succeeded.  
COM_VC_BankSoft.dll - 0 error(s), 0 warning(s)
```

Notice that Visual C++ compiles the files in the project, links them into a dynamic link library (DLL) called COM_VC_BankSoft.DLL, and registers the COM (ActiveX) class COM_VC_BankSoft.BSoftFin in the local registry.

Once the component is registered, it is accessible to the Integration Service running on that host.

Step 6. Register a COM Procedure with the Repository

1. Open the Transformation Developer.
2. Click Transformation > Import External Procedure.
The Import External COM Method dialog box appears.
3. Click the Browse button.
4. Select the COM DLL you created and click OK.
In the Banksoft example, select *COM_VC_Banksoft.DLL*.
5. Under Select Method tree view, expand the class node (in this example, BSoftFin).
6. Expand Methods.
7. Select the method you want (in this example, FV) and press OK.
The Designer creates an External Procedure transformation.
8. Open the External Procedure transformation, and select the Properties tab.
Enter the Module/Programmatic Identifier and Procedure Name fields.
9. Click the Ports tab.
10. Enter the Port names.
11. Click OK.

Step 7. Create a Source and a Target for a Mapping

Use the following SQL statements to create a source table and to populate this table with sample data:

```
create table FVInputs(  
    Rate float,  
    nPeriods int,  
    Payment float,  
    PresentValue float,  
    PaymentType int  
)  
  
insert into FVInputs values (.005,10,-200.00,-500.00,1)  
insert into FVInputs values (.01,12,-1000.00,0.00,0)  
insert into FVInputs values (.11/12,35,-2000.00,0.00,1)  
insert into FVInputs values (.005,12,-100.00,-1000.00,1)
```

Use the following SQL statement to create a target table:

```
create table FVOutputs(  
    FVin_ext_proc float,  
)
```

Use the Source Analyzer and the Target Designer to import FVInputs and FVOutputs into the same folder as the one in which you created the COM_BSFV transformation.

Step 8. Create a Mapping to Test the External Procedure Transformation

Now create a mapping to test the External Procedure transformation:

1. In the Mapping Designer, create a mapping named Test_BSFV.
2. Drag the source table FVInputs into the mapping.
3. Drag the target table FVOutputs into the mapping.

4. Drag the transformation COM_BSFV into the mapping.
5. Connect the Source Qualifier transformation ports to the External Procedure transformation ports as appropriate.
6. Connect the FV port in the External Procedure transformation to the FVIn_ext_proc target column.
7. Validate and save the mapping.

The following figure shows the complete mapping:

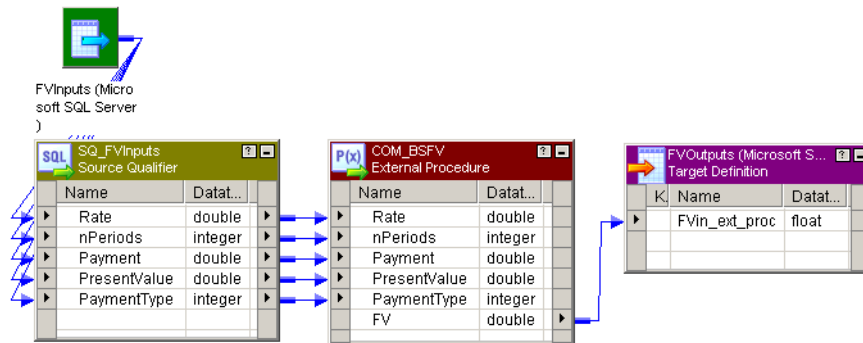

Step 9. Start the Integration Service

Start the Integration Service. The service must be started on the same host as the one on which the COM component was registered.

Step 10. Run a Workflow to Test the Mapping

When the Integration Service runs the session in a workflow, it performs the following functions:

- Uses the COM runtime facilities to load the DLL and create an instance of the class.
- Uses the COM IDispatch interface to call the external procedure you defined once for every row that passes through the mapping.

Note: Multiple classes, each with multiple methods, can be defined within a single project. Each of these methods can be invoked as an external procedure.

To run a workflow to test the mapping:

1. In the Workflow Manager, create the session s_Test_BSFV from the Test_BSFV mapping.
2. Create a workflow that contains the session s_Test_BSFV.
3. Run the workflow. The Integration Service searches the registry for the entry for the COM_VC_BankSoft.BSoftFin class. This entry has information that allows the Integration Service to determine the location of the DLL that contains that class. The Integration Service loads the DLL, creates an instance of the class, and invokes the FV function for every row in the source table.

When the workflow finishes, the FVOutputs table should contain the following results:

```
FVIn_ext_proc
2581.403374
12682.503013
```

`FVIn_ext_proc`

82846.246372

2301.401830

Developing COM Procedures with Visual Basic

Microsoft Visual Basic offers a different development environment for creating COM procedures. While the Basic language has different syntax and conventions, the development procedure has the same broad outlines as developing COM procedures in Visual C++.

RELATED TOPICS:

- [“Distributing External Procedures” on page 179](#)
- [“Wrapper Classes for Pre-Existing C/C++ Libraries or VB Functions” on page 182](#)

Step 1. Create a Visual Basic Project with a Single Class

1. Launch Visual Basic and click File > New Project.
2. In the dialog box that appears, select ActiveX DLL as the project type and click OK.
Visual Basic creates a new project named *Project1*.
If the Project window does not display, type Ctrl+R, or click View > Project Explorer.
If the Properties window does not display, press F4, or click View > Properties.
3. In the Project Explorer window for the new project, right-click the project and choose Project1 Properties from the menu that appears.
4. Enter the name of the new project.
In the Project window, select *Project1* and change the name in the Properties window to *COM_VB_BankSoft*.

Step 2. Change the Names of the Project and Class

1. Inside the Project Explorer, select the “Project – Project1” item, which should be the root item in the tree control. The project properties display in the Properties Window.
 2. Select the Alphabetic tab in the Properties Window and change the Name property to *COM_VB_BankSoft*. This renames the root item in the Project Explorer to *COM_VB_BankSoft (COM_VB_BankSoft)*.
 3. Expand the *COM_VB_BankSoft (COM_VB_BankSoft)* item in the Project Explorer.
 4. Expand the Class Modules item.
 5. Select the *Class1 (Class1)* item. The properties of the class display in the Properties Window.
 6. Select the Alphabetic tab in the Properties Window and change the Name property to *BSoftFin*.
- By changing the name of the project and class, you specify that the programmatic identifier for the class you create is “*COM_VB_BankSoft.BSoftFin*.” Use this ProgID to refer to this class inside the Designer.

Step 3. Add a Method to the Class

Place the pointer inside the Code window and enter the following text:

```
Public Function FV( _
```

```

    Rate As Double, _
    nPeriods As Long, _
    Payment As Double, _
    PresentValue As Double, _
    PaymentType As Long _
) As Double
Dim v As Double

v = (1 + Rate) ^ nPeriods

FV = -( _
    (PresentValue * v) + _
    (Payment * (1 + (Rate * PaymentType))) * ((v - 1) / Rate) _
)
End Function

```

This Visual Basic FV function performs the same operation as the C++ FV function in [“Developing COM Procedures with Visual Basic” on page 170](#).

Step 4. Build the Project

To build the project:

1. From the File menu, select the Make COM_VB_BankSoft.DLL. A dialog box prompts you for the file location.
2. Enter the file location and click OK.

Visual Basic compiles the source code and creates the COM_VB_BankSoft.DLL in the location you specified. It also registers the class COM_VB_BankSoft.BSoftFin in the local registry.

After the component is registered, it is accessible to the Integration Service running on that host.

Developing Informatica External Procedures

You can create external procedures that run on 32-bit or 64-bit Integration Service machines. Complete the following steps to create an Informatica-style external procedure:

1. In the Transformation Developer, create an External Procedure transformation.

The External Procedure transformation defines the signature of the procedure. The names of the ports, datatypes and port type (input or output) must match the signature of the external procedure.
2. Generate the template code for the external procedure.

When you execute this command, the Designer uses the information from the External Procedure transformation to create several C++ source code files and a makefile. One of these source code files contains a “stub” for the function whose signature you defined in the transformation.
3. Modify the code to add the procedure logic. Fill out the stub with an implementation and use a C++ compiler to compile and link the source code files into a dynamic link library or shared library.

When the Integration Service encounters an External Procedure transformation bound to an Informatica procedure, it loads the DLL or shared library and calls the external procedure you defined.
4. Build the library and copy it to the Integration Service machine.

5. Create a mapping with the External Procedure transformation.
6. Run the session in a workflow.

The BankSoft example illustrates how to implement this feature.

Step 1. Create the External Procedure Transformation

1. Open the Transformation Developer and create an External Procedure transformation.
2. Open the transformation and enter a name for it.
In the BankSoft example, enter EP_extINF_BSFV.
3. On the Ports tab, create a port for each argument passed to the procedure you plan to define.
Be sure that you use the correct datatypes.

The following table describes the ports:

Port Name	Datatype	Precision	Scale	Input/Output	Reusable
Rate	double	15	0	Input	No
nPeriods	integer	10	0	Input	No
Payment	double	15	0	Input	No
PresentValue	double	15	0	Input	No
PaymentType	integer	10	0	Input	No
FV	double	15	0	Output	Yes

The following BankSoft example shows an example of an External Procedure transformation:

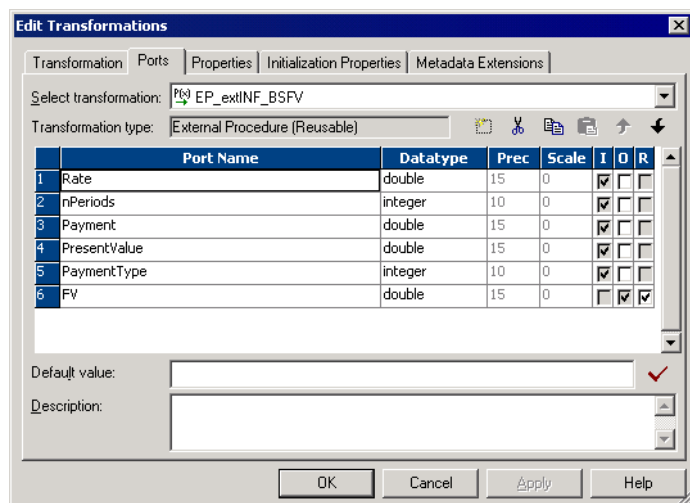

The last port, FV, captures the return value from the procedure.

4. Select the Properties tab and configure the procedure as an Informatica procedure.

In the BankSoft example, configure the following properties:

Transformation Attribute	Value
Type	Informatica
Module/Programmatic Identifier	INF_BankSoft
Procedure Name	FV
Runtime Location	\$PMEExtProcDir
Tracing Level	Normal
Is Partitionable	No
Output is Repeatable	Based On Input Order
Output is Deterministic	No

The following BankSoft example shows an example of an Informatica procedure:

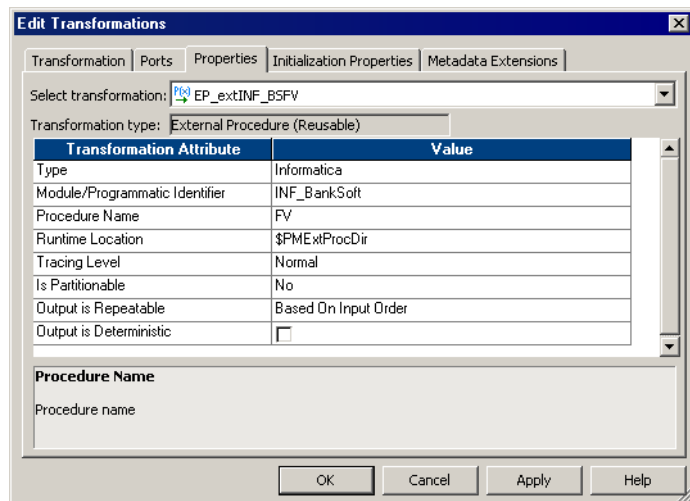

Note: on Module/Programmatic Identifier:

The following table describes how the module name determines the name of the DLL or shared object on the various platforms:

Operating System	Module Identifier	Library File Name
Windows	INF_BankSoft	INF_BankSoft.DLL
AIX	INF_BankSoft	libINF_BankSoftshr.a
HPUX	INF_BankSoft	libINF_BankSoft.sl

Operating System	Module Identifier	Library File Name
Linux	INF_BankSoft	libINF_BankSoft.so
Solaris	INF_BankSoft	libINF_BankSoft.so.1

5. Click OK.

After you create the External Procedure transformation that calls the procedure, the next step is to generate the C++ files.

Step 2. Generate the C++ Files

After you create an External Procedure transformation, you generate the code. The Designer generates file names in lower case since files created on UNIX-mapped drives are always in lower case. The following rules apply to the generated files:

- **File names.** A prefix 'tx' is used for TX module files.
- **Module class names.** The generated code has class declarations for the module that contains the TX procedures. A prefix *Tx* is used for TX module classes. For example, if an External Procedure transformation has a module name *Mymod*, then the class name is *TxMymod*.

To generate the code for an external procedure:

1. Select the transformation and click Transformation > Generate Code.
2. Select the check box next to the name of the procedure you just created.
In the BankSoft example, select *INF_BankSoft.FV*.
3. Specify the directory where you want to generate the files, and click Generate.

The Designer creates a subdirectory, *INF_BankSoft*, in the directory you specified.

Each External Procedure transformation created in the Designer must specify a module and a procedure name. The Designer generates code in a single directory for all transformations sharing a common module name. Building the code in one directory creates a single shared library.

The Designer generates the following files:

- **tx<moduleName>.h.** Defines the external procedure module class. This class is derived from a base class *TINFExternalModule60*. No data members are defined for this class in the generated code. However, you can add new data members and methods here.
- **tx<moduleName>.cpp.** Implements the external procedure module class. You can expand the *InitDerived()* method to include initialization of any new data members you add. The Integration Service calls the derived class *InitDerived()* method only when it successfully completes the base class *Init()* method.

This file defines the signatures of all External Procedure transformations in the module. Any modification of these signatures leads to inconsistency with the External Procedure transformations defined in the Designer. Therefore, you should not change the signatures.

This file also includes a C function `CreateExternalModuleObject`, which creates an object of the external procedure module class using the constructor defined in this file. The Integration Service calls `CreateExternalModuleObject` instead of directly calling the constructor.

- **<procedureName>.cpp**. The Designer generates one of these files for each external procedure in this module. This file contains the code that implements the procedure logic, such as data cleansing and filtering. For data cleansing, create code to read in values from the input ports and generate values for output ports. For filtering, create code to suppress generation of output rows by returning `INF_NO_OUTPUT_ROW`.
- **stdafx.h**. Stub file used for building on UNIX systems. The various *.cpp files include this file. On Windows systems, the Visual Studio generates an `stdafx.h` file, which should be used instead of the Designer generated file.
- **version.cpp**. This is a small file that carries the version number of this implementation. In earlier releases, external procedure implementation was handled differently. This file allows the Integration Service to determine the version of the external procedure module.
- **makefile.aix, makefile.aix64, makefile.hp, makefile.hp64, makefile.hpparisc64, makefile.linux, makefile.sol**. Make files for UNIX platforms. Use `makefile.aix`, `makefile.hp`, `makefile.linux`, and `makefile.sol` for 32-bit platforms. Use `makefile.aix64` for 64-bit AIX platforms and `makefile.hp64` for 64-bit HP-UX (Itanium) platforms.

Example 1

In the BankSoft example, the Designer generates the following files:

- **txinf_banksoft.h**. Contains declarations for module class `TxINF_BankSoft` and external procedure `FV`.
- **txinf_banksoft.cpp**. Contains code for module class `TxINF_BankSoft`.
- **fv.cpp**. Contains code for procedure `FV`.
- **version.cpp**. Returns TX version.
- **stdafx.h**. Required for compilation on UNIX. On Windows, `stdafx.h` is generated by Visual Studio.
- **readme.txt**. Contains general help information.

Example 2

If you create two External Procedure transformations with procedure names 'Myproc1' and 'Myproc2,' both with the module name `Mymod`, the Designer generates the following files:

- **txmymod.h**. Contains declarations for module class `TxMymod` and external procedures `Myproc1` and `Myproc2`.
- **txmymod.cpp**. Contains code for module class `TxMymod`.
- **myproc1.cpp**. Contains code for procedure `Myproc1`.
- **myproc2.cpp**. Contains code for procedure `Myproc2`.
- **version.cpp**.
- **stdafx.h**.
- **readme.txt**.

Step 3. Fill Out the Method Stub with Implementation

The final step is coding the procedure.

1. Open the <Procedure_Name>.cpp stub file generated for the procedure.
In the BankSoft example, you open fv.cpp to code the TxINF_BankSoft::FV procedure.
2. Enter the C++ code for the procedure.

The following code implements the FV procedure:

```
INF_RESULT TxINF_BankSoft::FV()
{
    // Input port values are mapped to the m_pInParameterVector array in
    // the InitParams method. Use m_pInParameterVector[i].IsValid() to check
    // if they are valid. Use m_pInParameterVector[i].GetLong or GetDouble,
    // etc. to get their value. Generate output data into m_pOutParamVector.
    // TODO: Fill in implementation of the FV method here.
    ostream ss;
    char* s;
    INF_BOOLEAN bVal;
    double v;
    TINFParam* Rate = &m_pInParameterVector[0];
    TINFParam* nPeriods = &m_pInParameterVector[1];
    TINFParam* Payment = &m_pInParameterVector[2];
    TINFParam* PresentValue = &m_pInParameterVector[3];
    TINFParam* PaymentType = &m_pInParameterVector[4];
    TINFParam* FV = &m_pOutParamVector[0];
    bVal =
        INF_BOOLEAN(
            Rate->IsValid() &&
            nPeriods->IsValid() &&
            Payment->IsValid() &&
            PresentValue->IsValid() &&
            PaymentType->IsValid()
        );
    if (bVal == INF_FALSE)
    {
        FV->SetIndicator(INF_SQL_DATA_NULL);
        return INF_SUCCESS;
    }
    v = pow((1 + Rate->GetDouble()), (double)nPeriods->GetLong());
    FV->SetDouble(
        -(
            (PresentValue->GetDouble() * v) +
            (Payment->GetDouble() *
             (1 + (Rate->GetDouble() * PaymentType->GetLong()))) *
            ((v - 1) / Rate->GetDouble())
        )
    );
    ss << "The calculated future value is: " << FV->GetDouble() <<ends;
    s = ss.str();
    (*m_pfnMessageCallback)(E_MSG_TYPE_LOG, 0, s);
    (*m_pfnMessageCallback)(E_MSG_TYPE_ERR, 0, s);
    delete [] s;
    return INF_SUCCESS;
}
```

The Designer generates the function profile, including the arguments and return value. You need to enter the actual code within the function, as indicated in the comments. Since you referenced the POW function and defined an ostream variable, you must also include the preprocessor statements:

On Windows:

```
#include <math.h>
#include <ostream> using namespace std;
```

On UNIX, the include statements would be the following:

```
#include <math.h>
#include <strstream.h>
```

3. Save the modified file.

Step 4. Building the Module

On Windows, use Visual C++ to compile the DLL.

Building the Module on Windows

To build a DLL on Windows:

1. Start Visual C++.
2. Click File > New.
3. In the New dialog box, click the Projects tab and select the MFC AppWizard (DLL) option.
4. Enter its location.
In the BankSoft example, you enter `c:\pmclient\tx\INF_BankSoft`, assuming you generated files in `c:\pmclient\tx`.
5. Enter the name of the project.
It must be the same as the module name entered for the External Procedure transformation. In the BankSoft example, it is `INF_BankSoft`.
6. Click OK.
Visual C++ now steps you through a wizard that defines all the components of the project.
7. In the wizard, click MFC Extension DLL (using shared MFC DLL).
8. Click Finish.
The wizard generates several files.
9. Click Project > Add To Project > Files.
10. Navigate up a directory level. This directory contains the external procedure files you created. Select all .cpp files.
In the BankSoft example, add the following files:
 - `fv.cpp`
 - `txinf_banksoft.cpp`
 - `version.cpp`
11. Click Project > Settings.
12. Click the C/C++ tab, and select Preprocessor from the Category field.
13. In the Additional Include Directories field, enter `..; <pmserver install dir>\extproc\include`.
14. Click the Link tab, and select General from the Category field.
15. Enter `<pmserver install dir>\bin\pmtx.lib` in the Object/Library Modules field.
16. Click OK.
17. Click Build > Build `INF_BankSoft.dll` or press F7 to build the project.
The compiler now creates the DLL and places it in the debug or release directory under the project directory.

Building the Module on UNIX

To build shared libraries on UNIX:

1. If you cannot access the PowerCenter Client tools directly, copy all the files you need for the shared library to the UNIX machine where you plan to perform the build.

For example, in the BankSoft procedure, use ftp or another mechanism to copy everything from the INF_BankSoft directory to the UNIX machine.

2. Set the environment variable INFA_HOME to the PowerCenter installation directory.

Warning: If you specify an incorrect directory path for the INFA_HOME environment variable, the Integration Service cannot start.

3. Enter the command to make the project.

The command depends on the version of UNIX, as summarized below:

UNIX Version	Command
AIX (32-bit)	make -f makefile.aix
AIX (64-bit)	make -f makefile.aix64
Linux	make -f makefile.linux
Solaris	make -f makefile.sol

Step 5. Create a Mapping

In the Mapping Designer, create a mapping that uses this External Procedure transformation.

Step 6. Run the Session

When you run the session, the Integration Service looks in the directory you specify as the Runtime Location to find the library (DLL) you built in Step 4. The default value of the Runtime Location property in the session properties is \$PMEExtProcDir.

To run a session:

1. In the Workflow Manager, create a workflow.
2. Create a session for this mapping in the workflow.
Tip: Alternatively, you can create a re-usable session in the Task Developer and use it in the workflow.
3. Copy the library (DLL) to the Runtime Location directory.
4. Run the workflow containing the session.

Running a Session with the Debug Version of the Module on Windows

Informatica ships PowerCenter on Windows with the release build (pmtx.dll) and the debug build (pmtxdbg.dll) of the External Procedure transformation library. These libraries are installed in the server bin directory.

If you build a release version of the module in Step 4, run the session in a workflow to use the release build (pmtx.dll) of the External Procedure transformation library. You do not need to complete the following task.

If you build a debug version of the module in Step 4, follow the procedure below to use the debug build (pmtxdbg.dll) of the External Procedure transformation library.

To run a session using a debug version of the module:

1. In the Workflow Manager, create a workflow.
2. Create a session for this mapping in the workflow.
You can also create a re-usable session in the Task Developer and use it in the workflow.
3. Copy the library (DLL) to the Runtime Location directory.
4. To use the debug build of the External Procedure transformation library:
 - Preserve pmtx.dll by renaming it or moving it from the server bin directory.
 - Rename pmtxdbg.dll to pmtx.dll.
5. Run the workflow containing the session.
6. To revert the release build of the External Procedure transformation library back to the default library:
 - Rename pmtx.dll back to pmtxdbg.dll.
 - Return/rename the original pmtx.dll file to the server bin directory.

Note: If you run a workflow containing this session with the debug version of the module on Windows, you must return the original pmtx.dll file to its original name and location before you can run a non-debug session.

Distributing External Procedures

Suppose you develop a set of external procedures and you want to make them available on multiple servers, each of which is running the Integration Service. The methods for doing this depend on the type of the external procedure and the operating system on which you built it.

You can also use these procedures to distribute external procedures to external customers.

Distributing COM Procedures

Visual Basic and Visual C++ register COM classes in the local registry when you build the project. Once registered, these classes are accessible to the Integration Service running on the machine where you compiled the DLL. For example, if you build a project on HOST1, all the classes in the project will be registered in the HOST1 registry and will be accessible to the Integration Service running on HOST1. Suppose, however, that you also want the classes to be accessible to the Integration Service running on HOST2. For this to happen, the classes must be registered in the HOST2 registry.

Visual Basic provides a utility for creating a setup program that can install COM classes on a Windows machine and register these classes in the registry on that machine. While no utility is available in Visual C++, you can easily register the class yourself.

Distributing a COM Visual Basic Procedure

To distribute a COM Visual Basic procedure:

1. After you build the DLL, exit Visual Basic and launch the Visual Basic Application Setup wizard.
2. Skip the first panel of the wizard.

3. On the second panel, specify the location of the project and select the *Create a Setup Program* option.
4. In the third panel, select the method of distribution you plan to use.
5. In the next panel, specify the directory to which you want to write the setup files.
For simple ActiveX components, you can continue to the final panel of the wizard. Otherwise, you may need to add more information, depending on the type of file and the method of distribution.
6. Click Finish in the final panel.
Visual Basic then creates the setup program for the DLL. Run this setup program on any Windows machine where the Integration Service is running.

Distributing a COM Visual Basic Procedure Manually

To distribute a COM Visual C++/Visual Basic procedure manually:

1. Copy the DLL to the directory on the new Windows machine anywhere you want it saved.
2. Log in to this Windows machine and open a DOS prompt.
3. Navigate to the directory containing the DLL and execute the following command:

```
REGSVR32 project_name.DLL
```

project_name is the name of the DLL you created. In the BankSoft example, the project name is *COM_VC_BankSoft.DLL*. or *COM_VB_BankSoft.DLL*.

This command line program then registers the DLL and any COM classes contained in it.

Distributing Informatica Modules

You can distribute external procedures between repositories.

To distribute external procedures between repositories:

1. Move the DLL or shared object that contains the external procedure to a directory on a machine that the Integration Service can access.
2. Copy the External Procedure transformation from the original repository to the target repository using the Designer client tool.

You can also export the External Procedure transformation to an XML file and import it in the target repository.

Development Notes

This section includes some additional guidelines and information about developing COM and Informatica external procedures.

COM Datatypes

When using either Visual C++ or Visual Basic to develop COM procedures, you need to use COM datatypes that correspond to the internal datatypes that the Integration Service uses when reading and transforming data. These datatype matches are important when the Integration Service attempts to map datatypes between ports in an External Procedure transformation and arguments (or return values) from the procedure the transformation calls.

The following table compares Visual C++ and transformation datatypes:

Visual C++ COM Datatype	Transformation Datatype
VT_I4	Integer
VT_UI4	Integer
VT_R8	Double
VT_BSTR	String
VT_DECIMAL	Decimal
VT_DATE	Date/Time

The following table compares Visual Basic and transformation datatypes:

Visual Basic COM Datatype	Transformation Datatype
Long	Integer
Double	Double
String	String
Decimal	Decimal
Date	Date/Time

If you do not correctly match datatypes, the Integration Service may attempt a conversion. For example, if you assign the Integer datatype to a port, but the datatype for the corresponding argument is BSTR, the Integration Service attempts to convert the Integer value to a BSTR.

Row-Level Procedures

All External Procedure transformations call procedures using values from a single row passed through the transformation. You cannot use values from multiple rows in a single procedure call. For example, you could not code the equivalent of the aggregate functions SUM or AVG into a procedure call. In this sense, all external procedures must be *stateless*.

Return Values from Procedures

When you call a procedure, the Integration Service captures an additional return value beyond whatever return value you code into the procedure. This additional value indicates whether the Integration Service successfully called the procedure.

For COM procedures, this return value uses the type HRESULT.

Informatica procedures use the type `INF_RESULT`. If the value returned is `S_OK/INF_SUCCESS`, the Integration Service successfully called the procedure. You must return the appropriate value to indicate the success or failure of the external procedure. Informatica procedures return four values:

- **INF_SUCCESS.** The external procedure processed the row successfully. The Integration Service passes the row to the next transformation in the mapping.
- **INF_NO_OUTPUT_ROW.** The Integration Service does not write the current row due to external procedure logic. This is not an error. When you use `INF_NO_OUTPUT_ROW` to filter rows, the External Procedure transformation behaves similarly to the Filter transformation.

Note: When you use `INF_NO_OUTPUT_ROW` in the external procedure, make sure you connect the External Procedure transformation to another transformation that receives rows from the External Procedure transformation only.

- **INF_ROW_ERROR.** Equivalent to a transformation error. The Integration Service discards the current row, but may process the next row unless you configure the session to stop on *n* errors.
- **INF_FATAL_ERROR.** Equivalent to an `ABORT()` function call. The Integration Service aborts the session and does not process any more rows.

Exceptions in Procedure Calls

The Integration Service captures most exceptions that occur when it calls a COM or Informatica procedure through an External Procedure transformation. For example, if the procedure call creates a divide by zero error, the Integration Service catches the exception.

In a few cases, the Integration Service cannot capture errors generated by procedure calls. Since the Integration Service supports only in-process COM servers, and since all Informatica procedures are stored in shared libraries and DLLs, the code running external procedures exists in the same address space in memory as the Integration Service. Therefore, it is possible for the external procedure code to overwrite the Integration Service memory, causing the Integration Service to stop. If COM or Informatica procedures cause such stops, review the source code for memory access problems.

Memory Management for Procedures

Since all the datatypes used in Informatica procedures are fixed length, there are no memory management issues for Informatica external procedures. For COM procedures, you need to allocate memory only if an [out] parameter from a procedure uses the `BSTR` datatype. In this case, you need to allocate memory on every call to this procedure. During a session, the Integration Service releases the memory after calling the function.

Wrapper Classes for Pre-Existing C/C++ Libraries or VB Functions

Suppose that BankSoft has a library of C or C++ functions and wants to plug these functions in to the Integration Service. In particular, the library contains BankSoft's own implementation of the FV function, called `PreExistingFV`. The general method for doing this is the same for both COM and Informatica external procedures. A similar solution is available in Visual Basic. You need only make calls to preexisting Visual Basic functions or to methods on objects that are accessible to Visual Basic.

Generating Error and Tracing Messages

The implementation of the Informatica external procedure `TxINF_BankSoft::FV` in ["Step 4. Building the Module" on page 177](#) contains the following lines of code:

```
ostringstream ss;

char* s;
```

```

...
ss << "The calculated future value is: " << FV->GetDouble() << ends;

s = ss.str();

(*m_pfnMessageCallback)(E_MSG_TYPE_LOG, 0, s);

(*m_pfnMessageCallback)(E_MSG_TYPE_ERR, 0, s);

delete [] s;

```

When the Integration Service creates an object of type Tx<MODNAME>, it passes to its constructor a pointer to a callback function that can be used to write error or debugging messages to the session log. (The code for the Tx<MODNAME> constructor is in the file Tx<MODNAME>.cpp.) This pointer is stored in the Tx<MODNAME> member variable m_pfnMessageCallback. The type of this pointer is defined in a typedef in the file \$PMExtProcDir/include/infemmsg.h:

```

typedef void (*PFN_MESSAGE_CALLBACK) (

    enum E_MSG_TYPE eMsgType,

    unsigned long Code,

    char* Message

);

```

Also defined in that file is the enumeration E_MSG_TYPE:

```

enum E_MSG_TYPE {

    E_MSG_TYPE_LOG = 0,

    E_MSG_TYPE_WARNING,

    E_MSG_TYPE_ERR

};

```

If you specify the eMsgType of the callback function as E_MSG_TYPE_LOG, the callback function will write a *log* message to the session log. If you specify E_MSG_TYPE_ERR, the callback function writes an *error* message to the session log. If you specify E_MSG_TYPE_WARNING, the callback function writes an *warning* message to the session log. Use these messages to provide a simple debugging capability in Informatica external procedures.

To debug COM external procedures, you may use the output facilities available from inside a Visual Basic or C++ class. For example, in Visual Basic use a MsgBox to print out the result of a calculation for each row. Of course, you want to do this only on small samples of data while debugging and make sure to remove the MsgBox before making a production run.

Note: Before attempting to use any output facilities from inside a Visual Basic or C++ class, you must add the following value to the registry:

1. Add the following entry to the Windows registry:

```

\HKEY_LOCAL_MACHINE\System\CurrentControlSet\Services\PowerMart\Parameters\MiscInfo
\RunInDebugMode=Yes

```

This option starts the Integration Service as a regular application, not a service. You can debug the Integration Service without changing the debug privileges for the Integration Service service while it is running.

2. Start the Integration Service from the command line, using the command PMSERVER.EXE.

The Integration Service is now running in debug mode.

When you are finished debugging, make sure you remove this entry from the registry or set `RunInDebugMode` to `No`. Otherwise, when you attempt to start PowerCenter as a service, it will not start.

1. Stop the Integration Service and change the registry entry you added earlier to the following setting:

```
\HKEY_LOCAL_MACHINE\System\CurrentControlSet\Services\PowerMart\Parameters\MiscInfo
\RunInDebugMode=No
```

2. Restart the Integration Service as a Windows service.

The TINFPParam Class and Indicators

The `<PROCNAME>` method accesses input and output parameters using two parameter arrays, and that each array element is of the `TINFPParam` datatype. The `TINFPParam` datatype is a C++ class that serves as a “variant” data structure that can hold any of the Informatica internal datatypes. The actual data in a parameter of type `TINFPParam*` is accessed through member functions of the form `Get<Type>` and `Set<Type>`, where `<Type>` is one of the Informatica internal datatypes. `TINFPParam` also has methods for getting and setting the indicator for each parameter.

You are responsible for checking these indicators on entry to the external procedure and for setting them on exit. On entry, the indicators of all output parameters are explicitly set to `INF_SQL_DATA_NULL`, so if you do not reset these indicators before returning from the external procedure, you will just get NULLs for all the output parameters. The `TINFPParam` class also supports functions for obtaining the metadata for a particular parameter. For a complete description of all the member functions of the `TINFPParam` class, see the `infemdef.h` include file in the `tx/include` directory.

One of the main advantages of Informatica external procedures over COM external procedures is that Informatica external procedures directly support indicator manipulation. That is, you can check an input parameter to see if it is NULL, and you can set an output parameter to NULL. COM provides no indicator support. Consequently, if a row entering a COM-style external procedure has any NULLs in it, the row cannot be processed. Use the default value facility in the Designer to overcome this shortcoming. However, it is not possible to pass NULLs out of a COM function.

Unconnected External Procedure Transformations

When you add an instance of an External Procedure transformation to a mapping, you can choose to connect it as part of the pipeline or leave it unconnected. Connected External Procedure transformations call the COM or Informatica procedure every time a row passes through the transformation.

To get return values from an unconnected External Procedure transformation, call it in an expression using the following syntax:

```
:EXT.transformation_name(arguments)
```

When a row passes through the transformation containing the expression, the Integration Service calls the procedure associated with the External Procedure transformation. The expression captures the return value of the procedure through the External Procedure transformation return port, which should have the `Result (R)` option checked.

Initializing COM and Informatica Modules

Some external procedures must be configured at initialization time. This initialization takes one of two forms, depending on the type of the external procedure:

- **Initialization of Informatica-style external procedures.** The Tx<MODNAME> class, which contains the external procedure, also contains the initialization function, Tx<MODNAME>::InitDerived. The signature of this initialization function is well-known to the Integration Service and consists of three parameters:

- **nInitProps.** This parameter tells the initialization function how many initialization properties are being passed to it.
- **Properties.** This parameter is an array of nInitProp strings representing the names of the initialization properties.
- **Values.** This parameter is an array of nInitProp strings representing the values of the initialization properties.

The Integration Service first calls the Init() function in the base class. When the Init() function successfully completes, the base class calls the Tx<MODNAME>::InitDerived() function.

The Integration Service creates the Tx<MODNAME> object and then calls the initialization function. It is the responsibility of the external procedure developer to supply that part of the Tx<MODNAME>::InitDerived() function that interprets the initialization properties and uses them to initialize the external procedure. Once the object is created and initialized, the Integration Service can call the external procedure on the object for each row.

- **Initialization of COM-style external procedures.** The object that contains the external procedure (or EP object) does not contain an initialization function. Instead, another object (the CF object) serves as a class factory for the EP object. The CF object has a method that can create an EP object.

The signature of the CF object method is determined from its type library. The Integration Service creates the CF object, and then calls the method on it to create the EP object, passing this method whatever parameters are required. This requires that the signature of the method consist of a set of input parameters, whose types can be determined from the type library, followed by a single output parameter that is an IUnknown** or an IDispatch** or a VARIANT* pointing to an IUnknown* or IDispatch*.

The input parameters hold the values required to initialize the EP object and the output parameter receives the initialized object. The output parameter can have either the [out] or the [out, retval] attributes. That is, the initialized object can be returned either as an output parameter or as the return value of the method. The datatypes supported for the input parameters are:

- COM VC type
- VT_UI1
- VT_BOOL
- VT_I2
- VT_UI2
- VT_I4
- VT_UI4
- VT_R4
- VT_R8
- VT_BSTR
- VT_CY
- VT_DATE

Setting Initialization Properties in the Designer

Enter external procedure initialization properties on the Initialization Properties tab of the Edit Transformations dialog box. The tab displays different fields, depending on whether the external procedure is COM-style or Informatica-style.

COM-style External Procedure transformations contain the following fields on the Initialization Properties tab:

- **Programmatic Identifier for Class Factory.** Enter the programmatic identifier of the class factory.
- **Constructor.** Specify the method of the class factory that creates the EP object.

You can enter an unlimited number of initialization properties to pass to the Constructor method for both COM-style and Informatica-style External Procedure transformations.

To add a new initialization property, click the Add button. Enter the name of the parameter in the Property column and enter the value of the parameter in the Value column. For example, you can enter the following parameters:

Parameter	Value
Param1	abc
Param2	100
Param3	3.17

Note: You must create a one-to-one relation between the initialization properties you define in the Designer and the input parameters of the class factory constructor method. For example, if the constructor has n parameters with the last parameter being the output parameter that receives the initialized object, you must define $n - 1$ initialization properties in the Designer, one for each input parameter in the constructor method.

You can also use process variables in initialization properties.

Other Files Distributed and Used in TX

Following are the header files located under the path `$PMExtProcDir/include` that are needed for compiling external procedures:

- infcfg.h
- infem60.h
- infemdef.h
- infemmsg.h
- infparam.h
- infsigtr.h

Following are the library files located under the path `<PMInstallDir>` that are needed for linking external procedures and running the session:

- libpmtx.a (AIX)
- libpmtx.so (Linux)
- libpmtx.so (Solaris)
- pmtx.dll and pmtx.lib (Windows)

Service Process Variables in Initialization Properties

PowerCenter supports built-in process variables in the External Procedure transformation initialization properties list. If the property values contain built-in process variables, the Integration Service expands them before passing them to the external procedure library. This can be very useful for writing portable External Procedure transformations.

The following table describes the initialization properties and values for an External Procedure transformation on the Initialization Properties tab of the transformation properties:

Table 2. External Procedure Initialization Properties

Property	Value	Expanded Value Passed to the External Procedure Library
mytempdir	\$PMTempDir	/tmp
memorysize	5000000	5000000
input_file	\$PMSourceFileDir/file.in	/data/input/file.in
output_file	\$PMTargetFileDir/file.out	/data/output/file.out
extra_var	\$some_other_variable	\$some_other_variable

When you run the workflow, the Integration Service expands the property list and passes it to the external procedure initialization function. Assuming that the values of the built-in process variables \$PMTempDir is */tmp*, \$PMSourceFileDir is */data/input*, and \$PMTargetFileDir is */data/output*, the last column in [“Service Process Variables in Initialization Properties” on page 187](#) contains the property and expanded value information. The Integration Service does not expand the last property “\$some_other_variable” because it is not a built-in process variable.

External Procedure Interfaces

The Integration Service uses the following major functions with External Procedures:

- Dispatch
- External procedure
- Property access
- Parameter access
- Code page access
- Transformation name access
- Procedure access
- Partition related
- Tracing level

Dispatch Function

The Integration Service calls the dispatch function to pass each input row to the external procedure module. The dispatch function, in turn, calls the external procedure function you specify.

External procedures access the ports in the transformation directly using the member variable `m_pInParamVector` for input ports and `m_pOutParamVector` for output ports.

Signature

The dispatch function has a fixed signature which includes one index parameter.

```
virtual INF_RESULT Dispatch(unsigned long ProcedureIndex) = 0
```

External Procedure Function

The external procedure function is the main entry point into the external procedure module, and is an attribute of the External Procedure transformation. The dispatch function calls the external procedure function for every input row. For External Procedure transformations, use the external procedure function for input and output from the external procedure module. The function can access the IN and IN-OUT port values for every input row, and can set the OUT and IN-OUT port values. The external procedure function contains all the input and output processing logic.

Signature

The external procedure function has no parameters. The input parameter array is already passed through the `InitParams()` method and stored in the member variable `m_pInParamVector`. Each entry in the array matches the corresponding IN and IN-OUT ports of the External Procedure transformation, in the same order. The Integration Service fills this vector before calling the dispatch function.

Use the member variable `m_pOutParamVector` to pass the output row before returning the `Dispatch()` function.

For the `MyExternal Procedure` transformation, the external procedure function is the following, where the input parameters are in the member variable `m_pInParamVector` and the output values are in the member variable `m_pOutParamVector`:

```
INF_RESULT Tx<ModuleName>::MyFunc()
```

Property Access Functions

The property access functions provide information about the initialization properties associated with the External Procedure transformation. The initialization property names and values appear on the Initialization Properties tab when you edit the External Procedure transformation.

Informatica provides property access functions in both the base class and the `TINFCfgEntriesList` class. Use the `GetConfigEntryName()` and `GetConfigEntryValue()` functions in the `TINFCfgEntriesList` class to access the initialization property name and value, respectively.

Signature

Informatica provides the following functions in the base class:

```
TINFCfgEntriesList* TINFBaseExternalModule60::accessConfigEntriesList();  
const char* GetConfigEntry(const char* LHS);
```

Informatica provides the following functions in the `TINFCfgEntriesList` class:

```
const char* TINFCfgEntriesList::GetConfigEntryValue(const char* LHS);
const char* TINFCfgEntriesList::GetConfigEntryValue(int i);
const char* TINFCfgEntriesList::GetConfigEntryName(int i);
const char* TINFCfgEntriesList::GetConfigEntry(const char* LHS)
```

Note: In the `TINFCfgEntriesList` class, use the `GetConfigEntryName()` and `GetConfigEntryValue()` property access functions to access the initialization property names and values.

You can call these functions from a TX program. The TX program then converts this string value into a number, for example by using `atoi` or `sscanf`. In the following example, "addFactor" is an Initialization Property. `accessConfigEntriesList()` is a member variable of the TX base class and does not need to be defined.

```
const char* addFactorStr = accessConfigEntriesList()-> GetConfigEntryValue("addFactor");
```

Parameter Access Functions

Parameter access functions are datatype specific. Use the parameter access function `GetDataType` to return the datatype of a parameter. Then use a parameter access function corresponding to this datatype to return information about the parameter.

A parameter passed to an external procedure belongs to the datatype `TINFParm*`. The header file `infparam.h` defines the related access functions. The Designer generates stub code that includes comments indicating the parameter datatype. You can also determine the datatype of a parameter in the corresponding External Procedure transformation in the Designer.

Signature

A parameter passed to an external procedure is a pointer to an object of the `TINFParm` class. This fixed-signature function is a method of that class and returns the parameter datatype as an enum value.

The valid datatypes are:

- `INF_DATATYPE_LONG`
- `INF_DATATYPE_STRING`
- `INF_DATATYPE_DOUBLE`
- `INF_DATATYPE_RAW`
- `INF_DATATYPE_TIME`

The following table describes some parameter access functions:

Parameter Access Function	Description
<code>INF_DATATYPE GetDataType(void);</code>	Gets the datatype of a parameter. Use the parameter datatype to determine which datatype-specific function to use when accessing parameter values.
<code>INF_BOOLEAN IsValid(void);</code>	Verifies that input data is valid. Returns <code>FALSE</code> if the parameter contains truncated data for the string or raw datatypes. Also returns <code>FALSE</code> when the input data exceeds the precision or the input data is a null value.
<code>INF_BOOLEAN IsNULL(void);</code>	Verifies that input data is <code>NULL</code> .

Parameter Access Function	Description
INF_BOOLEAN IsInputMapped (void);	Verifies that input port passing data to this parameter is connected to a transformation.
INF_BOOLEAN IsOutput Mapped (void);	Verifies that output port receiving data from this parameter is connected to a transformation.
INF_BOOLEAN IsInput(void);	Verifies that parameter corresponds to an input port.
INF_BOOLEAN IsOutput(void);	Verifies that parameter corresponds to an output port.
INF_BOOLEAN GetName(void);	Gets the name of the parameter.
SQLIndicator GetIndicator(void);	Gets the value of a parameter indicator. The IsValid and ISNULL functions are special cases of this function. This function can also return INF_SQL_DATA_TRUNCATED.
void SetIndicator(SQLIndicator Indicator);	Sets an output parameter indicator, such as invalid or truncated.
long GetLong(void);	Gets the value of a parameter having a Long or Integer datatype. Call this function only if you know the parameter datatype is Integer or Long. This function does not convert data to Long from another datatype.
double GetDouble(void);	Gets the value of a parameter having a Float or Double datatype. Call this function only if you know the parameter datatype is Float or Double. This function does not convert data to Double from another datatype.
char* GetString(void);	Gets the value of a parameter as a null-terminated string. Call this function only if you know the parameter datatype is String. This function does not convert data to String from another datatype. The value in the pointer changes when the next row of data is read. If you want to store the value from a row for later use, explicitly copy this string into its own allocated buffer.
char* GetRaw(void);	Gets the value of a parameter as a non-null terminated byte array. Call this function only if you know the parameter datatype is Raw. This function does not convert data to Raw from another datatype.
unsigned long GetActualDataLen(void);	Gets the current length of the array returned by GetRaw.
TINFTime GetTime(void);	Gets the value of a parameter having a Date/Time datatype. Call this function only if you know the parameter datatype is Date/Time. This function does not convert data to Date/Time from another datatype.
void SetLong(long lVal);	Sets the value of an output parameter having a Long datatype.
void SetDouble(double dblVal);	Sets the value of an output parameter having a Double datatype.
void SetString(char* sVal);	Sets the value of an output parameter having a String datatype.
void SetRaw(char* rVal, size_t ActualDataLen);	Sets a non-null terminated byte array.
void SetTime(TINFTime timeVal);	Sets the value of an output parameter having a Date/Time datatype.

Only use the SetInt32 or GetInt32 function when you run the external procedure on a 64-bit Integration Service. Do not use any of the following functions:

- GetLong
- SetLong
- GetpLong
- GetpDouble
- GetpTime

Pass the parameters using two parameter lists.

The following table lists the member variables of the external procedure base class:

Variable	Description
m_nInParamCount	Number of input parameters.
m_pInParamVector	Actual input parameter array.
m_nOutParamCount	Number of output parameters.
m_pOutParamVector	Actual output parameter array.
Note: Ports defined as input/output show up in both parameter lists.	

Code Page Access Functions

Informatica provides two code page access functions that return the code page of the Integration Service and two that return the code page of the data the external procedure processes. When the Integration Service runs in Unicode mode, the string data passing to the external procedure program can contain multibyte characters. The code page determines how the external procedure interprets a multibyte character string. When the Integration Service runs in Unicode mode, data processed by the external procedure program must be two-way compatible with the Integration Service code page.

Signature

Use the following functions to obtain the Integration Service code page through the external procedure program. Both functions return equivalent information.

```
int GetServerCodePageID() const;
const char* GetServerCodePageName() const;
```

Use the following functions to obtain the code page of the data the external procedure processes through the external procedure program. Both functions return equivalent information.

```
int GetDataCodePageID(); // returns 0 in case of error
const char* GetDataCodePageName() const; // returns NULL in case of error
```

Transformation Name Access Functions

Informatica provides two transformation name access functions that return the name of the External Procedure transformation. The GetWidgetName() function returns the name of the transformation, and the GetWidgetInstanceName() function returns the name of the transformation instance in the mapplet or mapping.

Signature

The `char*` returned by the transformation name access functions is an MBCS string in the code page of the Integration Service. It is not in the data code page.

```
const char* GetWidgetInstanceName() const;
const char* GetWidgetName() const;
```

Procedure Access Functions

Informatica provides two procedure access functions that provide information about the external procedure associated with the External Procedure transformation. The `GetProcedureName()` function returns the name of the external procedure specified in the Procedure Name field of the External Procedure transformation. The `GetProcedureIndex()` function returns the index of the external procedure.

Signature

Use the following function to get the name of the external procedure associated with the External Procedure transformation:

```
const char* GetProcedureName() const;
```

Use the following function to get the index of the external procedure associated with the External Procedure transformation:

```
inline unsigned long GetProcedureIndex() const;
```

Partition Related Functions

Use partition related functions for external procedures in sessions with multiple partitions. When you partition a session that contains External Procedure transformations, the Integration Service creates instances of these transformations for each partition. For example, if you define five partitions for a session, the Integration Service creates five instances of each external procedure at session runtime.

Signature

Use the following function to obtain the number of partitions in a session:

```
unsigned long GetNumberOfPartitions();
```

Use the following function to obtain the index of the partition that called this external procedure:

```
unsigned long GetPartitionIndex();
```

Tracing Level Function

The tracing level function returns the session trace level, for example:

```
typedef enum
{
    TRACE_UNSET = 0,
    TRACE_TERSE = 1,
    TRACE_NORMAL = 2,
    TRACE_VERBOSE_INIT = 3,
    TRACE_VERBOSE_DATA = 4
} TracingLevelType;
```

Signature

Use the following function to return the session trace level:

```
TracingLevelType GetSessionTraceLevel();
```

CHAPTER 9

Filter Transformation

This chapter includes the following topics:

- [Filter Transformation Overview, 194](#)
- [Filter Transformation Components, 195](#)
- [Filter Condition, 195](#)
- [Steps to Create a Filter Transformation, 196](#)
- [Tips for Filter Transformations, 196](#)

Filter Transformation Overview

Use the Filter transformation to filter out rows in a mapping. As an active transformation, the Filter transformation may change the number of rows passed through it. The Filter transformation allows rows that meet the specified filter condition to pass through. It drops rows that do not meet the condition. You can filter data based on one or more conditions. The Filter transformation is an active transformation.

A filter condition returns TRUE or FALSE for each row that the Integration Service evaluates, depending on whether a row meets the specified condition. For each row that returns TRUE, the Integration Services pass through the transformation. For each row that returns FALSE, the Integration Service drops and writes a message to the session log.

The following mapping passes the rows from a human resources table that contains employee data through a Filter transformation. The filter allows rows through for employees that make salaries of \$30,000 or higher.

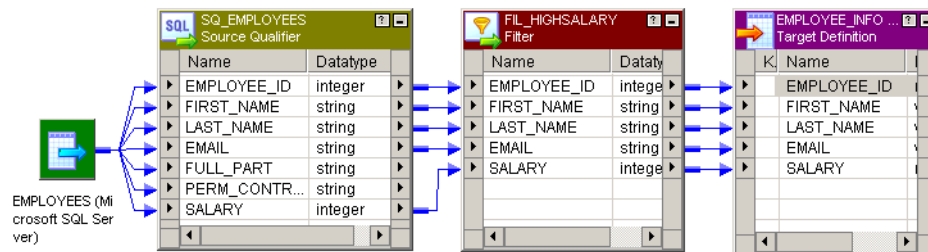

You cannot concatenate ports from more than one transformation into the Filter transformation. The input ports for the filter must come from a single transformation.

Tip: Place the Filter transformation as close to the sources in the mapping as possible to maximize session performance. Rather than passing rows you plan to discard through the mapping, you can filter out unwanted data early in the flow of data from sources to targets.

Filter Transformation Components

You can create a Filter transformation in the Transformation Developer or the Mapping Designer. A Filter transformation contains the following tabs:

- **Transformation.** Enter the name and description of the transformation. The naming convention for a Filter transformation is `FIL_TransformationName`. You can also make the transformation reusable.
- **Ports.** Create and configure ports.
- **Properties.** Configure the filter condition to filter rows. Use the Expression Editor to enter the filter condition. You can also configure the tracing level to determine the amount of transaction detail reported in the session log file.
- **Metadata Extensions.** Create a non-reusable metadata extension to extend the metadata of the transformation transformation. Configure the extension name, datatype, precision, and value. You can also promote a metadata extension to be reusable if you want to make it available to all transformations.

Configuring Filter Transformation Ports

You can create and modify ports on the Ports tab.

You can configure the following properties on the Ports tab:

- **Port name.** Name of the port.
- **Datatype, precision, and scale.** Configure the datatype and set the precision and scale for each port.
- **Port type.** All ports are input/output ports. The input ports receive data and output ports pass data.
- **Default values and description.** Set default value for ports and add description.

Filter Condition

The filter condition is an expression that returns TRUE or FALSE. Enter conditions using the Expression Editor available on the Properties tab.

Any expression that returns a single value can be used as a filter. For example, if you want to filter *out* rows for employees whose salary is less than \$30,000, you enter the following condition:

```
SALARY > 30000
```

You can specify multiple components of the condition, using the AND and OR logical operators. If you want to filter out employees who make less than \$30,000 and more than \$100,000, you enter the following condition:

```
SALARY > 30000 AND SALARY < 100000
```

You can also enter a constant for the filter condition. The numeric equivalent of FALSE is zero (0). Any non-zero value is the equivalent of TRUE. For example, the transformation contains a port named `NUMBER_OF_UNITS` with a numeric datatype. You configure a filter condition to return FALSE if the value of `NUMBER_OF_UNITS` equals zero. Otherwise, the condition returns TRUE.

You do not need to specify TRUE or FALSE as values in the expression. TRUE and FALSE are implicit return values from any condition you set. If the filter condition evaluates to NULL, the row is treated as FALSE.

Note: The filter condition is case sensitive.

Filtering Rows with Null Values

To filter rows containing null values or spaces, use the `ISNULL` and `IS_SPACES` functions to test the value of the port. For example, if you want to filter out rows that contain NULL value in the `FIRST_NAME` port, use the following condition:

```
IIF (ISNULL (FIRST_NAME) , FALSE, TRUE)
```

This condition states that if the `FIRST_NAME` port is NULL, the return value is FALSE and the row should be discarded. Otherwise, the row passes through to the next transformation.

Steps to Create a Filter Transformation

Use the following procedure to create a Filter transformation:

1. In the Mapping Designer, open a mapping.
2. Click Transformation > Create. Select Filter transformation.
3. Enter a name for the transformation. Click Create and then click Done.
4. Select and drag all the ports from a source qualifier or other transformation to add them to the Filter transformation.
5. Double-click on the title bar and click on Ports tab. You can also manually create ports within the transformation.
6. Click the Properties tab to configure the filter condition and tracing level.
7. In the Value section of the filter condition, open the Expression Editor.
8. Enter the filter condition you want to apply. The default condition returns TRUE.
Use values from one of the input ports in the transformation as part of this condition. However, you can also use values from output ports in other transformations.
9. Enter an expression. Click Validate to verify the syntax of the conditions you entered.
10. Select the tracing level.
11. Add metadata extensions on the Metadata Extensions tab.

Tips for Filter Transformations

Use the Filter transformation early in the mapping.

To maximize session performance, keep the Filter transformation as close as possible to the sources in the mapping. Rather than passing rows that you plan to discard through the mapping, you can filter out unwanted data early in the flow of data from sources to targets.

Use the Source Qualifier transformation to filter.

The Source Qualifier transformation provides an alternate way to filter rows. Rather than filtering rows from within a mapping, the Source Qualifier transformation filters rows when read from a source. The main difference is that the source qualifier limits *the row set extracted from a source*, while the Filter

transformation limits *the row set sent to a target*. Since a source qualifier reduces the number of rows used throughout the mapping, it provides better performance.

However, the Source Qualifier transformation only lets you filter rows from relational sources, while the Filter transformation filters rows from any type of source. Also, note that since it runs in the database, you must make sure that the filter condition in the Source Qualifier transformation only uses standard SQL. The Filter transformation can define a condition using any statement or transformation function that returns either a TRUE or FALSE value.

CHAPTER 10

HTTP Transformation

This chapter includes the following topics:

- [HTTP Transformation Overview, 198](#)
- [Creating an HTTP Transformation, 199](#)
- [Configuring the Properties Tab, 200](#)
- [Configuring the HTTP Tab, 201](#)
- [Examples, 207](#)

HTTP Transformation Overview

The HTTP transformation enables you to connect to an HTTP server to use its services and applications. The HTTP transformation is a passive transformation. When you run a session with an HTTP transformation, the Integration Service connects to the HTTP server and issues a request to retrieve data from or update data on the HTTP server, depending on how you configure the transformation:

- **Read data from an HTTP server.** When the Integration Service reads data from an HTTP server, it retrieves the data from the HTTP server and passes the data to the target or a downstream transformation in the mapping. For example, you can connect to an HTTP server to read current inventory data, perform calculations on the data during the PowerCenter session, and pass the data to the target.
- **Update data on the HTTP server.** When the Integration Service writes to an HTTP server, it posts data to the HTTP server and passes HTTP server responses to the target or a downstream transformation in the mapping. For example, you can post data providing scheduling information from upstream transformations to the HTTP server during a session.

The Integration Service passes data from upstream transformations or the source to the HTTP transformation, reads a URL configured in the HTTP transformation or application connection, and sends an HTTP request to the HTTP server to either read or update data.

Requests contain header information and may contain body information. The header contains information such as authentication parameters, commands to activate programs or web services residing on the HTTP server, and other information that applies to the entire HTTP request. The body contains the data the Integration Service sends to the HTTP server.

When the Integration Service sends a request to read data, the HTTP server sends back an HTTP response with the requested data. The Integration Service sends the requested data to downstream transformations or the target.

When the Integration Service sends a request to update data, the HTTP server writes the data it receives and sends back an HTTP response that the update succeeded. The HTTP transformation considers response

codes 200, 201, and 202 as a success. The HTTP transformation considers all other response codes as failures. The session log displays an error when an HTTP server passes a response code that is considered a failure to the HTTP transformation. The Integration Service then sends the HTTP response to downstream transformations or the target.

You can configure the HTTP transformation for the headers of HTTP responses. HTTP response body data passes through the HTTPOUT output port.

Authentication

The HTTP transformation uses the following forms of authentication:

- **Basic.** Based on a non-encrypted user name and password.
- **Digest.** Based on an encrypted user name and password.
- **NTLM.** Based on encrypted user name, password, and domain.

Connecting to the HTTP Server

When you configure an HTTP transformation, you can configure the URL for the connection. You can also create an HTTP connection object in the Workflow Manager. Configure an HTTP application connection in the following circumstances:

- The HTTP server requires authentication.
- You want to configure the connection timeout.
- You want to override the base URL in the HTTP transformation.

Creating an HTTP Transformation

You create HTTP transformations in the Transformation Developer or in the Mapping Designer. An HTTP transformation has the following tabs:

- **Transformation.** Configure the name and description for the transformation.
- **Ports.** View input and output ports for the transformation. You cannot add or edit ports on the Ports tab. The Designer creates ports on the Ports tab when you add ports to the header group on the HTTP tab.
- **Properties.** Configure properties for the HTTP transformation on the Properties tab.
- **HTTP.** Configure the method, ports, and URL on the HTTP tab.

To create an HTTP transformation:

1. In the Transformation Developer or Mapping Designer, click Transformation > Create.
2. Select HTTP transformation.
3. Enter a name for the transformation.
4. Click Create.
The HTTP transformation displays in the workspace.
5. Click Done.
6. Configure the tabs in the transformation.

Configuring the Properties Tab

The HTTP transformation is built using the Custom transformation. Some Custom transformation properties do not apply to the HTTP transformation or are not configurable.

The following table describes the HTTP transformation properties that you can configure:

Option	Description
Runtime Location	Location that contains the DLL or shared library. Default is \$PMEExtProcDir. Enter a path relative to the Integration Service node that runs the HTTP transformation session. If this property is blank, the Integration Service uses the environment variable defined on the Integration Service to locate the DLL or shared library. You must copy all DLLs or shared libraries to the runtime location or to the environment variable defined on the Integration Service node. The Integration Service fails to load the procedure when it cannot locate the DLL, shared library, or a referenced file.
Tracing Level	Amount of detail displayed in the session log for this transformation. Default is Normal.
Is Partitionable	Indicates if you can create multiple partitions in a pipeline that uses this transformation: <ul style="list-style-type: none">- No. The transformation cannot be partitioned. The transformation and other transformations in the same pipeline are limited to one partition.- Locally. The transformation can be partitioned, but the Integration Service must run all partitions in the pipeline on the same node. Choose Local when different partitions of the Custom transformation must share objects in memory.- Across Grid. The transformation can be partitioned, and the Integration Service can distribute each partition to different nodes. Default is No.
Output is Repeatable	Indicates if the order of the output data is consistent between session runs. <ul style="list-style-type: none">- Never. The order of the output data is inconsistent between session runs.- Based On Input Order. The output order is consistent between session runs when the input data order is consistent between session runs.- Always. The order of the output data is consistent between session runs even if the order of the input data is inconsistent between session runs. Default is Based on Input Order.
Requires Single Thread Per Partition	Indicates if the Integration Service processes each partition at the procedure with one thread.
Output is Deterministic	Indicates whether the transformation generates consistent output data between session runs. Enable this property to perform recovery on sessions that use this transformation. Default is enabled.

Warning: If you configure a transformation as repeatable and deterministic, it is your responsibility to ensure that the data is repeatable and deterministic. If you try to recover a session with transformations that do not produce the same data between the session and the recovery, the recovery process can result in corrupted data.

Configuring the HTTP Tab

On the HTTP tab, you can configure the transformation to read data from the HTTP server or write data to the HTTP server. Configure the following information on the HTTP tab:

- **Select the method.** Select GET, POST, SIMPLE POST, SIMPLE PATCH, SIMPLE PUT, or SIMPLE DELETE method based on whether you want to read data from or write data to an HTTP server, perform partial update or replace the entire data block, or to delete data from the HTTP server.
- **Configure groups and ports.** Manage HTTP request/response body and header details by configuring input and output ports. You can also configure port names with special characters.
- **Configure a base URL.** Configure the base URL for the HTTP server you want to connect to.

Selecting a Method

The groups and ports you define in a transformation depend on the method you select. To read data from an HTTP server, select the GET method. To write data to an HTTP server, select the POST or SIMPLE POST method.

The following table explains the different methods:

Method	Description
GET	Reads data from an HTTP server.
POST	Writes data from multiple input ports to the HTTP server.
SIMPLE POST	Writes data from one input port as a single block of data to the HTTP server.
SIMPLE PATCH	Updates partial data from one input port as a patch to the resource.
SIMPLE PUT	Replaces or writes a resource.
SIMPLE DELETE	Deletes a resource from the HTTP server.

Configuring Groups and Ports

The ports you add to an HTTP transformation depend on the method you choose and the group. An HTTP transformation uses the following groups:

- **Output.** Contains body data for the HTTP response. Passes responses from the HTTP server to downstream transformations or the target. By default, contains one output port, HTTPOUT. You cannot add ports to the output group. You can modify the precision for the HTTPOUT output port.
- **Input.** Contains body data for the HTTP request. Also contains metadata the Designer uses to construct the final URL to connect to the HTTP server. To write data to an HTTP server, the input group passes body information to the HTTP server. By default, contains one input port.
- **Header.** Contains header data for the request and response. Passes header information to the HTTP server when the Integration Service sends an HTTP request. Ports you add to the header group pass data for HTTP headers. When you add ports to the header group the Designer adds ports to the input and output groups on the Ports tab. By default, contains no ports. For all methods, you can use the header group for the HTTP request header information.

Note: The data that passes through an HTTP transformation must be of the String datatype. String data includes any markup language common in HTTP communication, such as HTML and XML.

GET Method

Reads data from an HTTP server. To define the metadata for the HTTP request, use the input group to add input ports that the Designer uses to construct the final URL for the HTTP server.

The following table describes the groups and ports for the GET method:

Request/Response	Group	Description
REQUEST	Input	The Designer uses the names and values of the input ports to construct the final URL.
REQUEST	Header	You can configure input and input/output ports for HTTP requests. The Designer adds ports to the input and output groups based on the ports you add to the header group: <ul style="list-style-type: none">- Input group. Creates input ports based on input and input/output ports from the header group.- Output group. Creates output ports based on input/output ports from the header group.
RESPONSE	Header	You can configure output and input/output ports for HTTP responses. The Designer adds ports to the input and output groups based on the ports you add to the header group: <ul style="list-style-type: none">- Input group. Creates input ports based on input/output ports from the header group.- Output group. Creates output ports based on output and input/output ports from the header group.
RESPONSE	Output	All body data for an HTTP response passes through the HTTPOUT output port.

POST Method

Writes data from multiple input ports to the HTTP server. To define the metadata for the HTTP request, use the input group for the data that defines the body of the HTTP request.

The following table describes the ports for the POST method:

Request/Response	Group	Description
REQUEST	Input	You can add multiple ports to the input group. Body data for an HTTP request can pass through one or more input ports based on what you add to the header group.
REQUEST	Header	You can configure input and input/output ports for HTTP requests. The Designer adds ports to the input and output groups based on the ports you add to the header group: <ul style="list-style-type: none">- Input group. Creates input ports based on input and input/output ports from the header group.- Output group. Creates output ports based on input/output ports from the header group.
RESPONSE	Header	You can configure output and input/output ports for HTTP responses. The Designer adds ports to the input and output groups based on the ports you add to the header group: <ul style="list-style-type: none">- Input group. Creates input ports based on input/output ports from the header group.- Output group. Creates output ports based on output and input/output ports from the header group.
RESPONSE	Output	All body data for an HTTP response passes through the HTTPOUT output port.

SIMPLE POST Method

A simplified version of the POST method. Writes data from one input port as a single block of data to the HTTP server. To define the metadata for the HTTP request, use the input group for the data that defines the body of the HTTP request.

The following table describes the ports for the SIMPLE POST method:

Request / Response	Group	Description
REQUEST	Input	You can add one input port. Body data for an HTTP request can pass through one input port.
REQUEST	Header	You can configure input and input/output ports for HTTP requests. The Designer adds ports to the input and output groups based on the ports you add to the header group: <ul style="list-style-type: none">- Input group. Creates input ports based on input and input/output ports from the header group.- Output group. Creates output ports based on input/output ports from the header group.
RESPONSE	Header	You can configure output and input/output ports for HTTP responses. The Designer adds ports to the input and output groups based on the ports you add to the header group: <ul style="list-style-type: none">- Input group. Creates input ports based on input/output ports from the header group.- Output group. Creates output ports based on output and input/output ports from the header group.
RESPONSE	Output	All body data for an HTTP response passes through the HTTPOUT output port.

SIMPLE PATCH Method

Updates partial data from one input port as a patch to the resource. Writes data from one input port as a complete or partial block of data to the HTTP server. To define the metadata for the HTTP request, use the input group for the data that defines the body of the HTTP request.

The following table describes the ports for the SIMPLE PATCH method:

Request / Response	Group	Description
REQUEST	Input	You can add one input port. Body data for an HTTP request can pass through one input port.
REQUEST	Header	You can configure input and input/output ports for HTTP requests. The Designer adds ports to the input and output groups based on the ports you add to the header group: <ul style="list-style-type: none">- Input group. Creates input ports based on input and input/output ports from the header group.- Output group. Creates output ports based on input/output ports from the header group.

Request / Response	Group	Description
RESPONSE	Header	You can configure output and input/output ports for HTTP responses. The Designer adds ports to the input and output groups based on the ports you add to the header group: <ul style="list-style-type: none"> - Input group. Creates input ports based on input/output ports from the header group. - Output group. Creates output ports based on output and input/output ports from the header group.
RESPONSE	Output	All body data for an HTTP response passes through the HTTPOUT output port.

SIMPLE PUT Method

Replaces or writes a resource. Writes data from one input port as a single block of data to the HTTP server.

If the data does not exist, the SIMPLE PUT method posts the data. If the data does exist, the SIMPLE PUT method updates data from one input port as a single block of data to the HTTP server.

To define the metadata for the HTTP request, use the input group for the data that defines the body of the HTTP request.

The following table describes the ports for the SIMPLE PUT method:

Request / Response	Group	Description
REQUEST	Input	You can add one input port. Body data for an HTTP request can pass through one input port.
REQUEST	Header	You can configure input and input/output ports for HTTP requests. The Designer adds ports to the input and output groups based on the ports you add to the header group: <ul style="list-style-type: none"> - Input group. Creates input ports based on input and input/output ports from the header group. - Output group. Creates output ports based on input/output ports from the header group.
RESPONSE	Header	You can configure output and input/output ports for HTTP responses. The Designer adds ports to the input and output groups based on the ports you add to the header group: <ul style="list-style-type: none"> - Input group. Creates input ports based on input/output ports from the header group. - Output group. Creates output ports based on output and input/output ports from the header group.
RESPONSE	Output	All body data for an HTTP response passes through the HTTPOUT output port.

SIMPLE DELETE Method

Deletes a resource from the HTTP server. If the request body is required, SIMPLE DELETE deletes data from an input port as a single block of data to the HTTP server. To define the metadata for the HTTP request, use the input group to add input ports that the Designer uses to construct the final URL for the HTTP server.

The following table describes the ports for the SIMPLE DELETE method:

Request/Response	Group	Description
REQUEST	Input	The Designer uses the names and values of the input ports to construct the final URL.
REQUEST	Header	You can configure input and input/output ports for HTTP requests. The Designer adds ports to the input and output groups based on the ports you add to the header group: <ul style="list-style-type: none">- Input group. Creates input ports based on input and input/output ports from the header group.- Output group. Creates output ports based on input/output ports from the header group.
RESPONSE	Header	You can configure output and input/output ports for HTTP responses. The Designer adds ports to the input and output groups based on the ports you add to the header group: <ul style="list-style-type: none">- Input group. Creates input ports based on input/output ports from the header group.- Output group. Creates output ports based on output and input/output ports from the header group.
RESPONSE	Output	All body data for an HTTP response passes through the HTTPOUT output port.

Adding an HTTP Name

The Designer does not allow special characters, such as a dash (-), in port names. If you need to use special characters in a port name, you can configure an HTTP name to override the name of a port. For example, if you want an input port named Content-type, you can name the port ContentType and enter Content-Type as the HTTP name.

Configuring a URL

After you select a method and configure input and output ports, you must configure a URL. Enter a base URL, and the Designer constructs the final URL. If you select the GET or SIMPLE DELETE method, the final URL contains the base URL and parameters based on the port names in the input group. If you select the SIMPLE PATCH, SIMPLE PUT, POST or SIMPLE POST methods, the final URL is the same as the base URL.

You can use a mapping parameter or variable to configure the base URL. For example, declare the mapping parameter \$\$ParamBaseURL, enter the mapping parameter \$\$ParamBaseURL in the base URL field, and then define \$\$ParamBaseURL in the parameter file.

You can also specify a URL when you configure an HTTP application connection. The base URL specified in the HTTP application connection overrides the base URL specified in the HTTP transformation.

Note: An HTTP server can redirect an HTTP request to another HTTP server. When this occurs, the HTTP server sends a URL back to the Integration Service, which then establishes a connection to the other HTTP server. The Integration Service can establish a maximum of five additional connections.

Final URL Construction for GET Method

The Designer constructs the final URL for the GET method based on the base URL and port names in the input group. It appends HTTP arguments to the base URL to construct the final URL in the form of an HTTP query string. A query string consists of a question mark (?), followed by name/value pairs. The Designer appends the question mark and the name/value pairs that correspond to the names and values of the input ports you add to the input group.

When you select the GET method and add input ports to the input group, the Designer appends the following group and port information to the base URL to construct the final URL:

```
?<input group input port 1 name> = ${<input group input port 1 value>
```

For each input port following the first input group input port, the Designer appends the following group and port information:

```
& <input group input port n name> = ${<input group input port n value>
```

where *n* represents the input port.

For example, if you enter `www.company.com` for the base URL and add the input ports ID, EmpName, and Department to the input group, the Designer constructs the following final URL:

```
www.company.com?ID=${ID}&EmpName=${EmpName}&Department=${Department}
```

You can edit the final URL to modify or add operators, variables, or other arguments. For more information about HTTP requests and query string, see <http://www.w3c.org>.

Parameterize Base URL

You can parameterize the base URL for the GET and SIMPLE DELETE methods.

For example, you have the following base URL:

```
www.informatica.com
```

The Designer uses the information in the base URL and might construct the final URL as follows:

```
www.informatica.com?firstname=1&lastname=2
```

When you select the checkbox option to parameterize the base URL in Designer for the GET or SIMPLE DELETE method, then you can edit the base URL to use the mapping parameter or variable as follows:

```
www.informatica.com/${firstname}${lastname}
```

The Integration Services sends the source file values to the first name and last name input port of the HTTP transformation and sends the HTTP requests to the HTTP server specified in the final URL.

The final URL then might appear as follows:

```
www.informatica.com/12
```

Special Characters in URL

When you configure a URL, the final URL might contain the special characters encoded in the UTF-8 character set.

The following table describes how some special characters used in the URL configures within the UTF-8 environment:

Special Characters	Encoded (UTF-8)
'	%27
(%28
)	%29

Special Characters	Encoded (UTF-8)
*	%2A
space	%20

If you use the `UseURLAsEnteredinCURLEncoding` custom flag at the Integration Service level or at the session level, you can pass the URL exactly as entered in Base URL (CURL encoding format).

Examples

This section contains examples for each type of method:

- GET
- POST
- SIMPLE POST
- SIMPLE PATCH
- SIMPLE PUT
- SIMPLE DELETE

GET Example

The source file used with this example contains the following data:

```
78576  
78577  
78578
```

The following figure shows the HTTP tab of the HTTP transformation for the GET example:

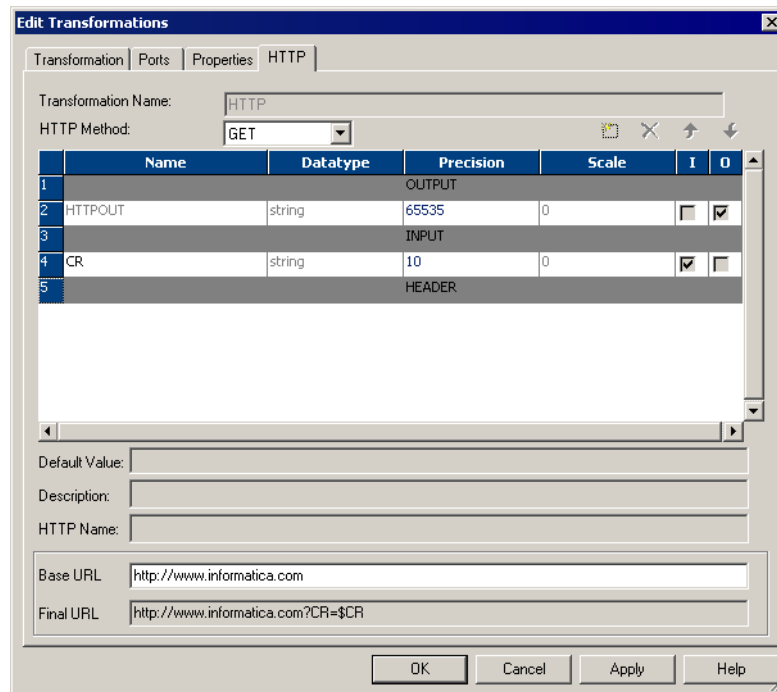

The Designer appends a question mark (?), the input group input port name, a dollar sign (\$), and the input group input port name again to the base URL to construct the final URL:

```
http://www.informatica.com?CR=$CR
```

The Integration Service sends the source file values to the CR input port of the HTTP transformation and sends the following HTTP requests to the HTTP server:

```
http://www.informatica.com?CR=78576  
http://www.informatica.com?CR=78577  
http://www.informatica.com?CR=78578
```

The HTTP server sends an HTTP response back to the Integration Service, which sends the data through the output port of the HTTP transformation to the target.

POST Example

The source file used with this example contains the following data:

```
33,44,1  
44,55,2  
100,66,0
```

The following figure shows that each field in the source file has a corresponding input port:

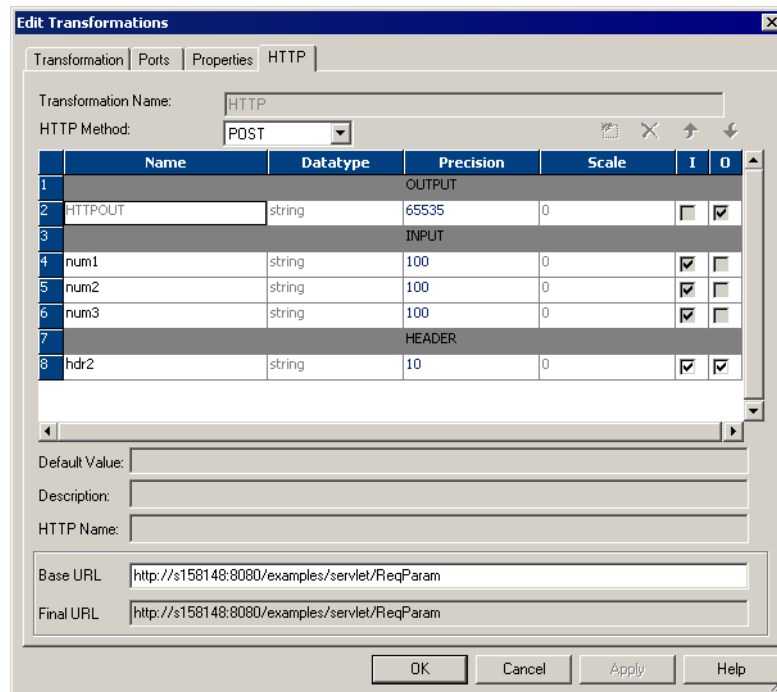

The Integration Service sends the values of the three fields for each row through the input ports of the HTTP transformation and sends the HTTP request to the HTTP server specified in the final URL.

SIMPLE POST Example

The following text shows the XML file used with this example:

```
<?xml version="1.0" encoding="UTF-8"?>
<n4:Envelope xmlns:cli="http://localhost:8080/axis/Clienttest1.jws" xmlns:n4="http://
schemas.xmlsoap.org/soap/envelope/" xmlns:tns="http://schemas.xmlsoap.org/soap/
encoding/" xmlns:xsi="http://www.w3.org/2001/XMLSchema-instance/" xmlns:xsd="http://
www.w3.org/2001/XMLSchema">
<n4:Header>
</n4:Header>
<n4:Body n4:encodingStyle="http://schemas.xmlsoap.org/soap/encoding/"><cli:smpsource>
<Metadataainfo xsi:type="xsd:string">smpsourceRequest.Metadataainfo106</Metadataainfo></
cli:smpsource>
</n4:Body>
<n4:Envelope>,capeconnect:Clienttest1services:Clienttest1#smpsource
```

The following figure shows the HTTP tab of the HTTP transformation for the SIMPLE POST example:

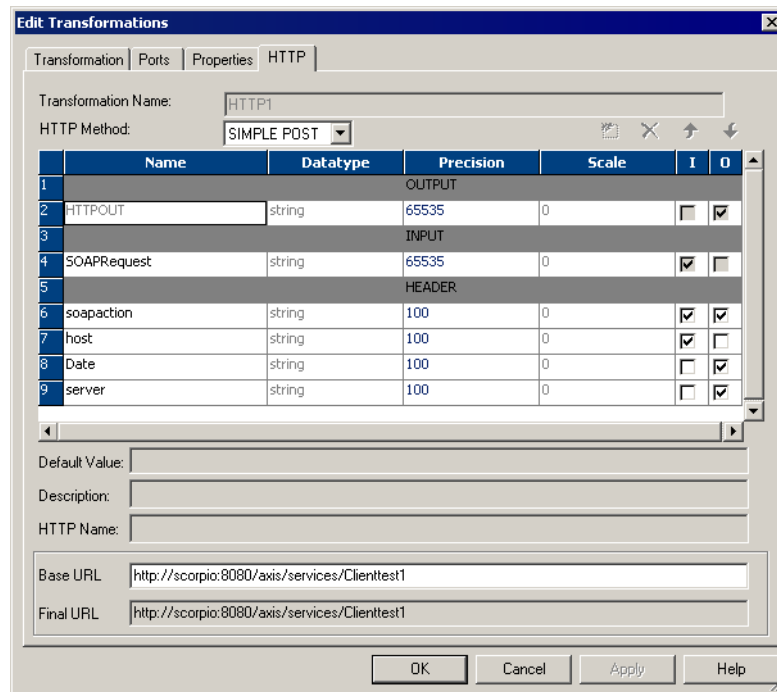

The Integration Service sends the body of the source file through the input port and sends the HTTP request to the HTTP server specified in the final URL.

SIMPLE PATCH Example

The source file used with this example contains the following data:

```
{"firstname": "Raj"}
```

The following figure shows that each field in the source file has a corresponding input port:

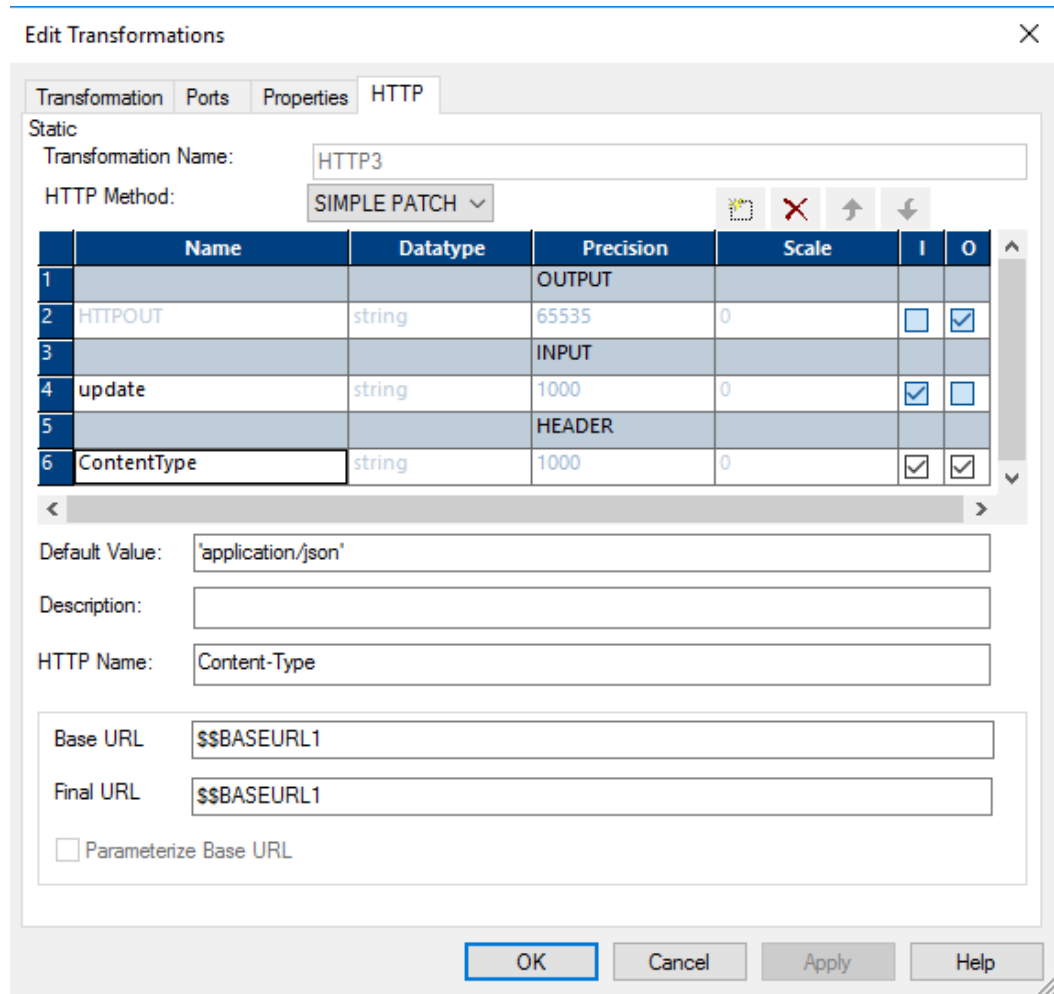

Include the \$\$BASEURL1 mapping variable as the Base URL and the final URL.

\$\$BASEURL1 mapping variable points to the following link:

http://avengers5:8181/emp_all/1/

SIMPLE PATCH supports partial data update from one input port to the HTTP server. The Integration Service sends the values of the affected row through the input ports of the HTTP transformation and sends the HTTP request to the HTTP server specified in the final URL.

SIMPLE PUT Example

The source file used with this example contains the following data:

```
{"emp_id": 10,"firstname": "Raj","lastname": "Kumar","designation": "QA","department": "RND","age": 24}
```

The following figure shows that each field in the source file has a corresponding input port:

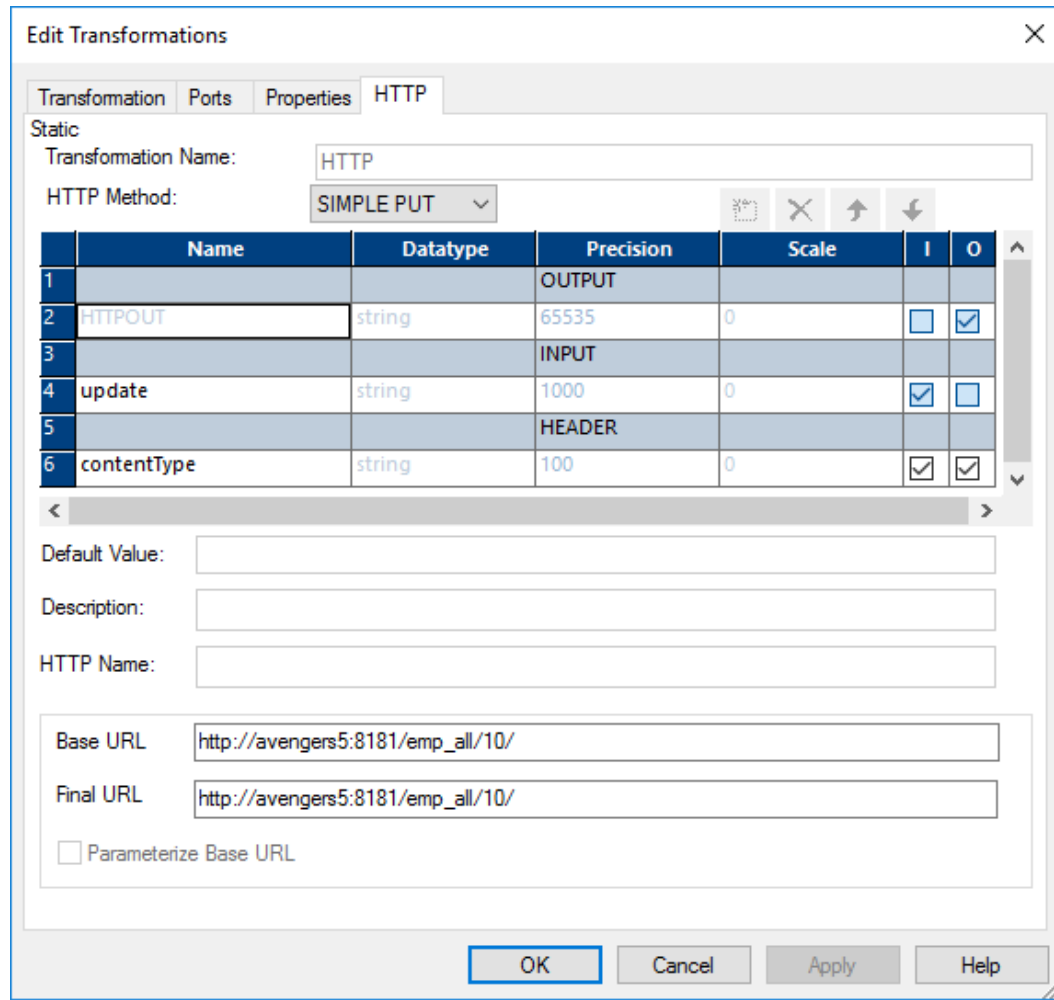

SIMPLE PUT writes data from one input port as a single block of data to the HTTP server. The Integration Service sends the body of the source file through the input port of the HTTP transformation and sends the HTTP request to the HTTP server specified in the final URL.

SIMPLE DELETE Example

The source file used with this example contains the following data:

```
2
1
```

The following figure shows the HTTP tab of the HTTP transformation for the SIMPLE DELETE example with the Parameterize Base URL option selected:

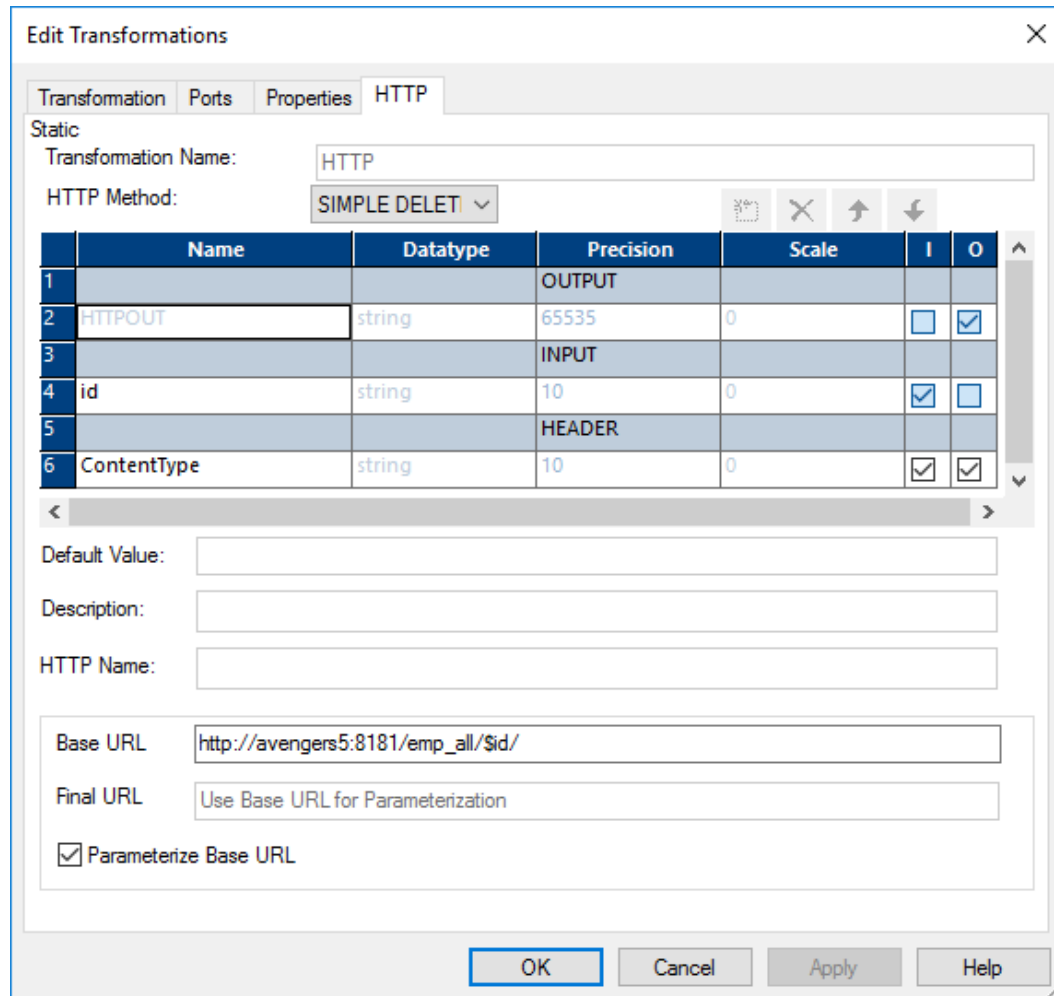

When you select the Parameterize Base URL check box, the Designer appends the input group input port name to the base URL to construct the final URL:

```
http://www.avengers5:8181/emp_all/$id/
```

The Integration Service sends the source file values to the id input port of the HTTP transformation and sends the following HTTP requests to the HTTP server:

```
http://www.avengers5:8181/emp_all/2
http://www.avengers5:8181/emp_all/1
```

The SIMPLE DELETE method deletes the required data from the HTTP server. The HTTP server sends an HTTP response back to the Integration Service, which sends the updated data through the output port of the HTTP transformation to the target.

CHAPTER 11

Identity Resolution Transformation

This chapter includes the following topics:

- [Identity Resolution Transformation Overview, 214](#)
- [Create and Configure the Transformation, 214](#)
- [Identity Resolution Transformation Tabs , 217](#)
- [Groups and Ports, 217](#)

Identity Resolution Transformation Overview

The Identity Resolution transformation is an active transformation that you can use to search and match data in Informatica Identity Resolution (IIR). The PowerCenter Integration Service uses the search definition that you specify in the Identity Resolution transformation to search and match data residing in the IIR tables. The input and output views in the system determine the input and output ports of the transformation.

Configure match tolerance and search width parameters in the Identity Resolution transformation to set the matching scheme and search level. When you run a session, IIR returns the candidate records to the Identity Resolution transformation.

IIR provides online and batch searching, matching, screening, linking and duplicate discovery for all types of identification data stored in Oracle, DB2/UDB, and Microsoft SQL Server tables. IIR uses the IIR Search Server perform to search and match operations.

Create and Configure the Transformation

Create an Identity Resolution transformation in the Transformation Developer. When you create an Identity Resolution transformation, you first connect to the Informatica Identity Resolution Search Server. The Search Server provides access to the IIR tables.

After you connect, you configure the system and the search and match parameters. Configure the following information in the **Configure IR Transformation** window:

- IR Search Server connection
- System and search configuration

- Input and output views

Search Server Connection

To connect to the Search Server, you provide a host name and port number. Then, you configure the Rulebase connection string. The Rulebase contains information about systems that IIR uses to search and match data. The Rulebase connection in an Identity Resolution transformation specifies the database that contains the Rulebase.

Note: You cannot change the host name or Rulebase connection after you create the transformation.

IR Hostname

Host name of the machine where the Informatica Identity Resolution Server runs.

Port

Port number of the Search Server.

Rulebase Connection String

Connection string to the Search Server. You can specify the Rulebase connection as ODBC or SSA. Configure ODBC and SSA in the IIR host.

ODBC

The following table describes the ODBC connection information:

Connection Property	Description
Rulebase Number	The number designated for the IR Rulebase.
User Name	Database user name.
Password	Password for the database user name.
Service Name	Service name defined in the odbc.ini file.

SSA

To connect through SSA, you need to provide the alias. The alias hides the connection string from application programs. IIR uses aliases for Rulebases, databases, and source names.

System and Search Configuration

After you connect to the Search Server, you choose the system and search and match parameters.

You can change these parameters on the **IR Settings** tab after you create the transformation.

System

Choose the system in the Rulebase. A system is the highest level logical definition in an IIR Rulebase.

Search Definition

Choose the search definition that contains the rules for the system. The search definition resides in a system and contains the rules to search, match, and display records.

Search Width

Choose the search width that determines the scope of the search that you want to conduct.

The following table describes the search widths that you can choose:

Search Width	Description
Narrow	Provides a narrow search with a quick response time. Use this option when you have a low risk associated with missing a match, when you do not require a high match accuracy, or when the data volume is large and response time is critical.
Typical	Provides a balance between quality and response time. Use this option for online or batch transaction searches. Default is typical.
Exhaustive	Provides a detailed search with an extended response time. Use this option when you have a high risk associated with missing a match, when data quality is a concern, or when the data volume is low and response time is not critical.

Match Tolerance

Choose the match tolerance that determines how aggressive the matching scheme is to select candidate records.

The following table describes the match tolerance options that you can choose:

Match Tolerance	Description
Extreme	Delivers a candidate match with a set of possible methods for processing. Response time for processing is more. Use this option when you need to find a match even it contains errors and variation.
Conservative	Delivers matches that are not excessive or extreme. Use for online or batch transaction searches.
Typical	Delivers close matches. Use in batch systems when you need an accurate match.
Loose	Delivers matches with a higher degree of variation than the typical level. Use in systems where the risk of missing a match is high and when you can review results.

View Selection

After you select the system and search definition, you can choose the input view and output view.

Input View

The fields in the input view determine the transformation input ports. The input view contains the fields used for search and match operations. If you do not choose an input view, the transformation uses the IIR Identity Table (IDT) layout for the input view.

Note: If the system contains the XFORM clause in the view definition to concatenate multiple fields into one field, you cannot use the view in the Identity Resolution transformation. However, you can concatenate multiple fields outside the Identity Resolution transformation, and pass the concatenated string to the input ports of the Identity Resolution transformation.

Output View

The fields in the output view determine the transformation output ports. The output view formats search results returned by the Search Server. If you do not choose an output view, the transformation uses the IIR Identity Table (IDT) layout for the output view.

Identity Resolution Transformation Tabs

The Identity Resolution transformation has the following tabs:

Transformation

Configure the transformation description.

Ports

View the groups and ports that represent input and output views. You cannot edit the groups and ports.

Properties

The following table describes the properties that you can configure on the **Properties** tab:

Transformation Attribute	Description
Run-time Location	Location that contains the DLL or shared library. Default is \$PMExtProcDir.
Tracing Level	Amount of detail displayed in the session log for this transformation. Default is Normal.
Is Partitionable	Indicates if you can create multiple partitions in a pipeline that uses this transformation: <ul style="list-style-type: none">- No. The transformation cannot be partitioned. The transformation and the other transformations in the same pipeline are limited to one partition.- Locally. The transformation can be partitioned, but the Integration Service must run all partitions in the pipeline on the same node. Choose Locally when different partitions of the Custom transformation must share objects in memory.- Across Grid. The transformation can be partitioned, and the Integration Service can distribute each partition to different nodes. Default is Across Grid.

IR Settings

View the settings that you configured when you created the transformation. You can change the system and search information.

Groups and Ports

An Identity Resolution transformation contains an input group and an output group. The input group has ports that represent fields in the input view of the search definition. The output group has ports that represent fields in the output view of the search definition in addition to ports that describe the result of the search.

You can view groups and ports on the **Ports** tab. You can also view ports on the **IR Settings** tab.

Input Groups and Ports

An Identity Resolution transformation contains an input group with input ports. The number of ports in the input group match the number of fields in the selected input view. Link all input ports required by the search to the Identity Resolution transformation.

Output Groups and Ports

The output group contains output ports and an input/output port. The output group contains ports from the output view in addition to default ports for each Identity Resolution transformation.

The output ports that are based on the output view contain candidate records from the Search Server.

The following table describes the default output ports:

Default Output Ports	Description
IR_Search_Link	Input/output search link port. Use this pass-through port to pass a link between the source data on the input side and resultant output candidates.
IR_Score_Out	Output port that contains the score from the search operation conducted by the Search Server. Values are positive numbers from 0 through 100. For example, if you search on name with the input "Rob," the results may contain candidate records with name "Rob" that have a score of 100. The results may also contain candidate records with name as "Bob" that have a score of 90. Informatica Identity Resolution computes the score associated with the result.
IR_Result_Count	Output port that contains the number of records.

CHAPTER 12

Java Transformation

This chapter includes the following topics:

- [Java Transformation Overview, 219](#)
- [Using the Java Code Tab, 221](#)
- [Configuring Ports, 222](#)
- [Configuring Java Transformation Properties, 224](#)
- [Developing Java Code, 226](#)
- [Configuring Java Transformation Settings, 230](#)
- [Compiling a Java Transformation, 232](#)
- [Fixing Compilation Errors, 233](#)

Java Transformation Overview

Extend PowerCenter functionality with the Java transformation. The Java transformation provides a simple native programming interface to define transformation functionality with the Java programming language. You can use the Java transformation to quickly define simple or moderately complex transformation functionality without advanced knowledge of the Java programming language or an external Java development environment. The Java transformation can be a passive or active transformation.

The PowerCenter Client uses the Java Development Kit (JDK) to compile the Java code and generate byte code for the transformation. The PowerCenter Client stores the byte code in the PowerCenter repository.

The Integration Service uses the Java Runtime Environment (JRE) to execute generated byte code at run time. When the Integration Service runs a session with a Java transformation, the Integration Service uses the JRE to execute the byte code and process input rows and generate output rows.

Create Java transformations by writing Java code snippets that define transformation logic. Define transformation behavior for a Java transformation based on the following events:

- The transformation receives an input row.
- The transformation has processed all input rows.
- The transformation receives a transaction notification such as commit or rollback.

RELATED TOPICS:

- [“Java Transformation API Reference” on page 235](#)
- [“Java Expressions” on page 245](#)

Steps to Define a Java Transformation

Complete the following steps to write and compile Java code and fix compilation errors in a Java transformation:

1. Create the transformation in the Transformation Developer or Mapping Designer.
2. Configure input and output ports and groups for the transformation. Use port names as variables in Java code snippets.
3. Configure the transformation properties.
4. Use the code entry tabs in the transformation to write and compile the Java code for the transformation.
5. Locate and fix compilation errors in the Java code for the transformation.

Active and Passive Java Transformations

A Java transformation generates output rows differently based on whether the transformation is active or passive.

After you create the transformation, you cannot change whether the transformation is active or passive.

Active Java Transformation

An active transformation can change the number of rows that pass through it.

To define the number of rows in the output, call the `generateRow()` method in the code to generate each output row. You might choose to generate multiple output rows from a single input row or generate a single output row from multiple input rows. For example, if the transformation contains two input ports that represent a start date and an end date, you can call the `generateRow()` method to generate an output row for each date between the start date and the end date.

Passive Java Transformation

A passive transformation cannot change the number of rows that pass through the transformation. The transformation calls the `generateRow()` method to generate an output row after processing each input row.

Data Type Conversion

A Java transformation converts PowerCenter data types to Java data types, based on the Java transformation port type.

When a Java transformation reads input rows, it converts input port data types to Java data types.

When a Java transformation writes output rows, it converts Java data types to output port data types.

For example, the following processing occurs for an input port with the integer data type in a Java transformation:

1. The Java transformation converts the integer data type of the input port to the Java primitive `int` data type.
2. In the transformation, the transformation treats the value of the input port as the Java primitive `int` data type.
3. When the transformation generates the output row, it converts the Java primitive `int` data type to the integer data type.

The following table shows how the Java transformation maps PowerCenter data types to Java primitive and complex data types:

PowerCenter Data Type	Java Data Type
Char	String
Binary	byte[]
Long (INT32)	int
Double	double
Decimal	double BigDecimal
BIGINT	long
Date/Time	BigDecimal long (number of milliseconds since January 1, 1970 00:00:00.000 GMT)

The Java transformation sets null values in primitive data types to zero. You can use the `isNull` and the `setNull` API methods on the **On Input Row** tab to set null values in the input port to null values in the output port. For an example, see [“setNull” on page 242](#).

Note: The decimal data type maps to `BigDecimal` when high precision is enabled. `BigDecimal` cannot be used with some operators, such as the `+` operator. If the Java code contains an expression that uses a decimal port and the port is used with one of the operators, the Java code fails to compile.

Using the Java Code Tab

Use the Java Code tab to define, compile, and fix compilation errors in Java code. Create code snippets in the code entry tabs.

When you define the java code, you can perform the following task:

- Define static code or a static block, instance variables, and user-defined methods.
- Define Java expressions, and define transformation logic.
- Use Java transformation API methods and standard Java language constructs.
- Import third-party Java APIs, built-in Java packages, or custom Java packages. You can use Java code snippets from Java packages.

After you develop code snippets, you can compile the Java code and view the results of the compilation in the Output window or view the full Java code.

The Java Code tab contains the following components:

- **Navigator.** Add input or output ports or APIs to a code snippet. The Navigator lists the input and output ports for the transformation, the available Java transformation APIs, and a description of the port or API function. For input and output ports, the description includes the port name, type, datatype, precision, and scale. For API functions, the description includes the syntax and use of the API function.

The Navigator disables any port or API function that is unavailable for the code entry tab. For example, you cannot add ports or call API functions from the Import Packages code entry tab.

- **Code window.** Develop Java code for the transformation. The code window uses basic Java syntax highlighting.
- **Code entry tabs.** Define transformation behavior. Each code entry tab has an associated Code window. To enter Java code for a code entry tab, click the tab and write Java code in the Code window.
- **Define Expression link.** Opens the Define Expression dialog box that you use to create Java expressions.
- **Settings link.** Opens the Settings dialog box. Use the Settings dialog box to set the classpath for third-party and custom Java packages, to enable high precision for Decimal datatypes, and to process subsecond data. The PowerCenter Client includes files within the classpath when it compiles the Java code.
- **Compile link.** Compiles the Java code for the transformation. Output from the Java compiler, including error and informational messages, appears in the Output window.
- **Full Code link.** Opens the Full Code window to display the complete class code for the Java transformation. The complete code for the transformation includes the Java code from the code entry tabs added to the Java transformation class template.
- **Output window.** Displays the compilation results for the Java transformation class. You can right-click an error message in the Output window to locate the error in the snippet code or the full code for the Java transformation class in the Full Code window. You can also double-click an error in the Output window to locate the source of the error.

Configuring Ports

A Java transformation can have input ports, output ports, and input/output ports. You create and edit groups and ports on the Ports tab. You can specify default values for ports. After you add ports to a transformation, use the port names as variables in Java code snippets.

Creating Groups and Ports

When you create a Java transformation, it includes one input group and one output group.

A Java transformation always has one input group and one output group. The transformation is not valid if it has multiple input or output groups. You can change the existing group names by typing in the group header. If you delete a group, you can add a new group by clicking the Create Input Group or Create Output Group icon.

When you create a port, the Designer adds it below the currently selected row or group. An input/output port that appears below the input group it is also part of the output group. An input/output port that appears below the output group it is also part of the input group.

Setting Default Port Values

You can define default values for ports in a Java transformation.

The Java transformation initializes port variables with the default port value based on the datatype of the port.

Input and Output Ports

The Java transformation initializes the value of unconnected input ports or output ports that do not have an assigned value in the Java code snippets.

Java transformation initializes ports based on the following Java data types:

Primitive data type

If you define a default value for the port that is not equal to null, the transformation initializes the value of the port variable to the default value. Otherwise, it initializes the value of the port variable to 0.

Complex data type

If you define a default value for the port, the transformation creates a new object, and initializes the object to the default value. Otherwise, the transformation initializes the port variable to null. For example, if you define a default value for a string port, the transformation creates a new String object, and initializes the String object to the default value.

Note: If you access an input port variable with a null value in the Java code, a `NullPointerException` occurs.

You can enable an input port as a partition key and a sort key, and you can assign a sort direction. The Data Integration Service partitions the data and sorts the data in each partition by the sort key and sort direction. The Partition Key and Sort Key are valid when the transformation scope is set to All Input.

Use the following properties for partitioning and sorting data:

Partition Key

Input port that determines the rows of data to group into the same partition.

You can enable one or more input rows as partition keys. The Data Integration Service uses the partition keys to repartition the data before the code runs. If you do not select an input row as a partition key, the data is processed using its default partitioning scheme.

Sort Key

Input port that determines the sort criteria within each partition.

Direction

Ascending or descending order. Default is ascending.

Input/Output Ports

The Java transformation treats input/output ports as pass-through ports. If you do not set a value for the port in the Java code for the transformation, the output value is the same as the input value. The Java transformation initializes the value of an input/output port in the same it initializes an input port.

If you set the value of a port variable for an input/output port in the Java code, the Java transformation uses this value when it generates an output row. If you do not set the value of an input/output port, the Java transformation sets the value of the port variable to 0 for simple datatypes and NULL for complex datatypes when it generates an output row.

Configuring Java Transformation Properties

The Java transformation includes properties for both the transformation code and the transformation. If you create a Java transformation in the Transformation Developer, you can override the transformation properties when you use it in a mapping.

The following table describes the Java transformation properties:

Property	Description
Language	Language used for the transformation code. You cannot change this value.
Class Name	Name of the Java class for the transformation. You cannot change this value.
Tracing Level	Amount of detail displayed in the session log for this transformation. Use the following tracing levels: <ul style="list-style-type: none">- Terse- Normal- Verbose Initialization- Verbose Data Default is Normal.
Is Partitionable	Multiple partitions in a pipeline can use this transformation. Use the following options: <ul style="list-style-type: none">- No. The transformation cannot be partitioned. The transformation and other transformations in the same pipeline are limited to one partition. You might choose No if the transformation processes all the input data together, such as data cleansing.- Locally. The transformation can be partitioned, but the Integration Service must run all partitions in the pipeline on the same node. Choose Locally when different partitions of the transformation must share objects in memory.- Across Grid. The transformation can be partitioned, and the Integration Service can distribute each partition to different nodes. Default is No.
Inputs Must Block	The procedure associated with the transformation must be able to block incoming data. Default is enabled.
Is Active	The transformation can generate more than one output row for each input row. You cannot change this property after you create the Java transformation. If you need to change this property, create a new Java transformation.
Update Strategy Transformation	The transformation defines the update strategy for output rows. You can enable this property for active Java transformations. Default is disabled.
Transformation Scope	The method in which the Integration Service applies the transformation logic to incoming data. Use the following options: <ul style="list-style-type: none">- Row- Transaction- All Input This property is always Row for passive transformations. Default is All Input for active transformations.

Property	Description
Generate Transaction	The transformation generates transaction rows. You can enable this property for active Java transformations. Default is disabled.
Output Is Repeatable	The order of the output data is consistent between session runs. <ul style="list-style-type: none"> - Never. The order of the output data is inconsistent between session runs. - Based On Input Order. The output order is consistent between session runs when the input data order is consistent between session runs. - Always. The order of the output data is consistent between session runs even if the order of the input data is inconsistent between session runs. Default is Never for active transformations. Default is Based On Input Order for passive transformations.
Requires Single Thread Per Partition	A single thread processes the data for each partition. You cannot change this value.
Output Is Deterministic	The transformation generates consistent output data between session runs. Enable this property to perform recovery on sessions that use this transformation. Default is enabled.

Warning: If you configure a transformation as repeatable and deterministic, it is your responsibility to ensure that the data is repeatable and deterministic. If you try to recover a session with transformations that do not produce the same data between the session and the recovery, the recovery process can result in corrupted data.

Working with Transaction Control

You can define transaction control for a Java transformation using the following properties:

- **Transformation Scope.** Determines how the Integration Service applies the transformation logic to incoming data.
- **Generate Transaction.** Indicates that the Java code for the transformation generates transaction rows and passes them to the output group.

Transformation Scope

You can configure how the Integration Service applies the transformation logic to incoming data. You can choose one of the following values:

- **Row.** Applies the transformation logic to one row of data at a time. Choose Row when the results of the transformation depend on a single row of data. You must choose Row for passive transformations.
- **Transaction.** Applies the transformation logic to all rows in a transaction. Choose Transaction when the results of the transformation depend on all rows in the same transaction, but not on rows in other transactions. For example, you might choose Transaction when the Java code performs aggregate calculations on the data in a single transaction.
- **All Input.** Applies the transformation logic to all incoming data. When you choose All Input, the Integration Service drops transaction boundaries. Choose All Input when the results of the transformation depend on all rows of data in the source. For example, you might choose All Input when the Java code for the transformation sorts all incoming data.

Generate Transaction

You can define Java code in an active Java transformation to generate transaction rows, such as commit and rollback rows. To generate transaction rows, enable the transformation to generate transaction rows.

When you configure the transformation to generate transaction rows, the Integration Service treats the Java transformation like a Transaction Control transformation. Most rules that apply to a Transaction Control transformation in a mapping also apply to the Java transformation. For example, when you configure a Java transformation to generate transaction rows, you cannot concatenate pipelines or pipeline branches containing the transformation.

When you edit or create a session using a Java transformation configured to generate transaction rows, configure it for user-defined commit.

RELATED TOPICS:

- [“commit” on page 236](#)
- [“rollBack” on page 241](#)

Setting the Update Strategy

Use an active Java transformation to set the update strategy for a mapping. You can set the update strategy at the following levels:

- **Within the Java code.** You can write the Java code to set the update strategy for output rows. The Java code can flag rows for insert, update, delete, or reject. For more about setting the update strategy, see [“setOutRowType” on page 242](#).
- **Within the mapping.** Use the Java transformation in a mapping to flag rows for insert, update, delete, or reject. Select the Update Strategy Transformation property for the Java transformation.
- **Within the session.** Configure the session to treat the source rows as data driven.

If you do not configure the Java transformation to define the update strategy, or you do not configure the session as data driven, the Integration Service does not use the Java code to flag the output rows. Instead, the Integration Service flags the output rows as insert.

Developing Java Code

Use the code entry tabs to enter Java code snippets that define Java transformation functionality. You can write Java code using the code entry tabs to import Java packages, write helper code, define Java expressions, and write Java code that defines transformation behavior for specific transformation events. You can develop snippets in the code entry tabs in any order.

Enter Java code in the following code entry tabs:

- **Import Packages.** Import third-party Java packages, built-in Java packages, or custom Java packages.
- **Helper Code.** Define variables and methods available to all tabs except Import Packages.
- **On Input Row.** Define transformation behavior when it receives an input row.
- **On End of Data.** Define transformation behavior when it has processed all input data.
- **On Receiving Transaction.** Define transformation behavior when it receives a transaction notification. Use with active Java transformations.

- **Java Expressions.** Define Java expressions to call PowerCenter expressions. You can use Java expressions in the Helper Code, On Input Row, On End of Data, and On Transaction code entry tabs.

Access input data and set output data on the On Input Row tab. For active transformations, you can also set output data on the On End of Data and On Receiving Transaction tabs.

Creating Java Code Snippets

To create Java code snippets to define transformation behavior, use the **Code** window on the **Java Code** tab.

1. Click the appropriate code entry tab.
2. To access input or output column variables in the snippet, double-click the name of the port in the navigator.
3. To call a Java transformation API in the snippet, double-click the name of the API in the navigator. If necessary, configure the appropriate API input values.
4. Write appropriate Java code, based on the code snippet.

View the full class code for the Java transformation in the **Full Code** windows.

Importing Java Packages

On the **Import Package** tab, you can import Java packages for active or passive Java transformations.

You can import third-party, built-in, or custom Java packages. After you import Java packages, you can use the imported packages on the other code entry tabs.

Note: On the **Import Packages** tab, you cannot declare or use static variables, instance variables, or user methods.

In the PowerCenter Client, when you export or import metadata that contains a Java transformation, the jar or class files that contain the third-party or custom packages required by the Java transformation are not included in the export or import.

If you import metadata that contains a Java transformation, you must copy the jar or class files that contain the required third-party or custom packages to the PowerCenter Client and Integration Service node.

For example, to import the Java I/O package, enter the following code on the **Import Packages** tab:

```
import java.io.*;
```

When you import non-standard Java packages, add the package or class to the classpath in the Java transformation settings.

RELATED TOPICS:

- [“Configuring Java Transformation Settings” on page 230](#)

Defining Helper Code

On the **Helper Code** tab, you can declare user-defined variables and methods for the Java transformation class in active or passive Java transformations.

After you declare variables and methods on the **Helper Code** tab, you can use the variables and methods on any code entry tab except the **Import Packages** tab.

On the **Helper Code** tab, you can declare the following types of code, variables, and methods:

- Static code and static variables.

Within a static block, you can declare static variables and static code. All instances of a reusable Java transformation in a mapping and all partitions in a session share static code and variables. Static code runs before any other code in a Java transformation.

For example, the following code declares a static variable to store the error threshold for all instances of a Java transformation in a mapping:

```
static int errorThreshold;
```

Use this variable to store the error threshold for the transformation and access it from all instances of the Java transformation in a mapping and from any partition in a session.

Note: You must synchronize static variables in a multiple partition session or in a reusable Java transformation.

- **Instance variables.**

You can declare partition-level instance variables. Multiple instances of a reusable Java transformation in a mapping or multiple partitions in a session do not share instance variables. Declare instance variables with a prefix to avoid conflicts and initialize non-primitive instance variables.

For example, the following code uses a boolean variable to decide whether to generate an output row:

```
// boolean to decide whether to generate an output row
// based on validity of input
private boolean generateRow;
```

- **User-defined static or instance methods.**

Extends the functionality of the Java transformation. Java methods declared on the **Helper Code** tab can use or modify output variables or locally declared instance variables. You cannot access input variables from Java methods on the **Helper Code** tab.

For example, use the following code on the tab to declare a function that adds two integers:

```
private int myTXAdd (int num1,int num2)
{
    return num1+num2;
}
```

On Input Row Tab

Use the On Input Row tab to define the behavior of the Java transformation when it receives an input row. The Java code in this tab executes one time for each input row. You can access input row data in the On Input Row tab only.

Access and use the following input and output port data, variables, and methods from the On Input Row tab:

- **Input port and output port variables.** Access input and output port data as a variable by using the name of the port as the name of the variable. For example, if “in_int” is an Integer input port, you can access the data for this port by referring as a variable “in_int” with the Java primitive datatype int. You do not need to declare input and output ports as variables.

Do not assign a value to an input port variable. If you assign a value to an input variable in the On Input Row tab, you cannot get the input data for the corresponding port in the current row.

- **Instance variables and user-defined methods.** Use any instance or static variable or user-defined method you declared in the Helper Code tab.

For example, an active Java transformation has two input ports, BASE_SALARY and BONUSSES, with an integer datatype, and a single output port, TOTAL_COMP, with an integer datatype. You create a user-defined method in the Helper Code tab, myTXAdd, that adds two integers and returns the result. Use the

following Java code in the On Input Row tab to assign the total values for the input ports to the output port and generate an output row:

```
TOTAL_COMP = myTXAdd (BASE_SALARY, BONUSES);
generateRow();
```

When the Java transformation receives an input row, it adds the values of the BASE_SALARY and BONUSES input ports, assigns the value to the TOTAL_COMP output port, and generates an output row.

- **Java transformation API methods.** You can call API methods provided by the Java transformation.

On End of Data Tab

Use the On End of Data tab in active or passive Java transformations to define the behavior of the Java transformation when it has processed all input data. To generate output rows in the On End of Data tab, set the transformation scope for the transformation to Transaction or All Input. You cannot access or set the value of input port variables in this tab.

Access and use the following variables and methods from the On End of Data tab:

- **Output port variables.** Use the names of output ports as variables to access or set output data for active Java transformations.
- **Instance variables and user-defined methods.** Use any instance variables or user-defined methods you declared in the Helper Code tab.
- **Java transformation API methods.** Call API methods provided by the Java transformation. Use the commit and rollBack API methods to generate a transaction.

For example, use the following Java code to write information to the session log when the end of data is reached:

```
logInfo("Number of null rows for partition is: " + partCountNullRows);
```

On Receiving Transaction Tab

Use the On Receiving Transaction tab in active Java transformations to define the behavior of an active Java transformation when it receives a transaction notification. The code snippet for the On Receiving Transaction tab is only executed if the Transaction Scope for the transformation is set to Transaction. You cannot access or set the value of input port variables in this tab.

Access and use the following output data, variables, and methods from the On Receiving Transaction tab:

- **Output port variables.** Use the names of output ports as variables to access or set output data.
- **Instance variables and user-defined methods.** Use any instance variables or user-defined methods you declared in the Helper Code tab.
- **Java transformation API methods.** Call API methods provided by the Java transformation. Use the commit and rollBack API methods to generate a transaction. For example, use the following Java code to generate a transaction after the transformation receives a transaction:

```
commit();
```

Using Java Code to Parse a Flat File

You can develop Java code to parse a flat file. Use Java code to extract specific columns of data from a flat file of varying schema or a JMS message.

For example, you want to read the first two columns of data from a delimited flat file. Create a mapping that reads data from a delimited flat file and passes data to one or more output ports.

The mapping contains the following components:

- **Source definition.** The source is a delimited flat file. Configure the source to pass rows of a flat file as a string to the Java transformation. The source file has the following data:

```
1a,2a,3a,4a,5a,6a,7a,8a,9a,10a
1b,2b,3b,4b,5b,6b,7b,8b,9b
1c,2c,3c,4c,5c,6c,7c
1d,2d,3d,4d,5d,6d,7d,8d,9d,10d
```

- **Java transformation.** Define the Java transformation functionality on the Java Code tab.

Use the Import Packages tab of the Java Code to import the java package. Enter the following code on the Import Packages tab:

```
import java.util.StringTokenizer;
```

Use the On Input Row tab of the Java Code tab to read each row of data from a string and pass the data to output ports. Enter the following code on the On Input Row tab to retrieve the first two columns of data:

```
StringTokenizer st1 = new StringTokenizer(row, ",");
f1 = st1.nextToken();
f11= st1.nextToken();
```

- **Target definition.** Configure the target to receive rows of data from the Java Transformation. After you run a workflow that contains the mapping, the target contains two columns of data. The target file has the following data:

```
1a,2a
1b,2b
1c,2c
1d,2d
```

Configuring Java Transformation Settings

You can configure Java transformation settings to set the classpath for third-party and custom Java packages and to enable high precision for Decimal datatypes. You also can configure the transformation to process subseconds data.

Configuring the Classpath

When you import non-standard Java packages in the Import package tab, set the classpath for the PowerCenter Client and the Integration Service to each JAR file or class file directory associated with the Java package. On UNIX, use a colon to separate classpath entries. On Windows, use a semicolon to separate classpath entries. The JAR or class files must be accessible on the PowerCenter Client and the Integration Service node.

For example, you import the Java package `converter` in the Import Packages tab and define the package in `converter.jar`. You must add `converter.jar` to the classpath before you compile the Java code for the Java transformation.

You do not need to set the classpath for built-in Java packages. For example, `java.io` is a built-in Java package. If you import `java.io`, you do not need to set the classpath for `java.io`.

Configuring the Classpath for the Integration Service

You can add JAR files or class file directories to the Integration Service classpath. To set the classpath on the Integration Service node, complete one of the following tasks:

- **Configure the Java Classpath session property.** Set the classpath using the Java Classpath session property. This classpath applies to the session.
- **Configure the Java SDK Classpath.** Configure the Java SDK Classpath on the Processes tab of the Integration Service properties in the Informatica Administrator. This setting applies to all sessions run on the Integration Service.
- **Configure the CLASSPATH environment variable.** Set the CLASSPATH environment variable on the Integration Service node. Restart the Integration Service after you set the environment variable. This applies to all sessions run on the Integration Service.

Configuring the Classpath for the Integration Service on UNIX

To configure the CLASSPATH environment variable on UNIX:

- ▶ In a UNIX C shell environment, type:

```
setenv CLASSPATH <classpath>
```

- ▶ In a UNIX Bourne shell environment, type:

```
CLASSPATH = <classpath>  
export CLASSPATH
```

Configuring the Classpath for the Integration Service on Windows

To configure the CLASSPATH environment variable on Windows:

- ▶ Enter the environment variable CLASSPATH, and set the value to the default classpath.

Configuring the Classpath for the PowerCenter Client

You can add jar files or class file directories to the PowerCenter Client classpath.

To set the classpath for the machine where the PowerCenter Client runs, complete one of the following tasks:

- Configure the CLASSPATH environment variable. Set the CLASSPATH environment variable on the PowerCenter Client machine. This applies to all java processes run on the machine.
- Configure the the classpath in the Java transformation settings. This applies to sessions that include this Java transformation. The PowerCenter Client includes files within the classpath when it compiles the java code.

To add jar or class file directories to the classpath in a Java transformation, complete the following steps:

1. On the **Java Code** tab, click the **Settings** linkclick the down arrow icon in the **Value** column next to **Classpath**.
The **Settings** dialog box appears.
2. Click Browse under **Add Classpath** to select the jar file or class file directory for the imported package. Click **OK**.
3. Click **Add**.
The jar or class file directory appears in the list of jar and class file directories for the transformation.
4. To remove a jar file or class file directory, select the jar or class file directory and click **Remove**.
The directory disappears from the list of directories.

Enabling High Precision

By default, the Java transformation converts ports of type Decimal to double datatypes with a precision of 15. If you want to process a Decimal datatype with a precision greater than 15, enable high precision to process decimal ports with the Java class BigDecimal.

When you enable high precision, you can process Decimal ports with precision less than 28 as BigDecimal. The Java transformation converts decimal data with a precision greater than 28 to the Double datatype. Java transformation expressions process binary, integer, double, and string data. Java transformation expressions cannot process bigint data.

For example, a Java transformation has an input port of type Decimal that receives a value of 40012030304957666903. If you enable high precision, the value of the port is treated as it appears. If you do not enable high precision, the value of the port is $4.00120303049577 \times 10^{19}$.

Note: If you enable high precision for a Java transformation, also enable high precision for the session that includes the Java transformation. If high precision is enabled in the Java Transformation and it is not enabled in the session, the session may fail with the following error:

```
[ERROR]Failed to bind column with index <index number> to datatype <datatype name>.
```

Processing Subseconds

You can process subsecond data up to nanoseconds in the Java code. When you configure the settings to use nanoseconds in datetime values, the generated Java code converts the transformation Date/Time datatype to the Java BigDecimal datatype, which has precision to the nanosecond.

By default, the generated Java code converts the transformation Date/Time datatype to the Java Long datatype, which has precision to the millisecond.

Compiling a Java Transformation

The PowerCenter Client uses the Java compiler to compile the Java code and generate the byte code for the transformation.

The Java compiler compiles the Java code and displays the results of the compilation in the **Output** window on the code entry tabs. The Java compiler installs with the PowerCenter Client in the `java/bin` directory.

To compile the full code for the Java transformation, click **Compile** on the **Java Code** tab.

When you create a Java transformation, it contains a Java class that defines the base functionality for a Java transformation. The full code for the Java class contains the template class code for the transformation, plus the Java code you define on the code entry tabs.

When you compile a Java transformation, the PowerCenter Client adds the code from the code entry tabs to the template class for the transformation to generate the full class code for the transformation. The PowerCenter Client then calls the Java compiler to compile the full class code. The Java compiler compiles the transformation and generates the byte code for the transformation.

The results of the compilation display in the **Output** window. Use the results of the compilation to identify and locate Java code errors.

Note: The Java transformation is also compiled when you click **OK** in the transformation.

Fixing Compilation Errors

You can identify Java code errors and locate the source of Java code errors for a Java transformation in the Output window. Java transformation errors may occur as a result of an error in a code entry tab or may occur as a result of an error in the full code for the Java transformation class.

To troubleshoot a Java transformation:

- **Locate the source of the error.** You can locate the source of the error in the Java snippet code or in the full class code for the transformation.
- **Identify the type of error.** Use the results of the compilation in the output window and the location of the error to identify the type of error.

After you identify the source and type of error, fix the Java code in the code entry tab and compile the transformation again.

Locating the Source of Compilation Errors

When you compile a Java transformation, the Output window displays the results of the compilation. Use the results of the compilation to identify compilation errors. When you use the Output window to locate the source of an error, the PowerCenter Client highlights the source of the error in a code entry tab or in the Full Code window.

You can locate errors in the Full Code window, but you cannot edit Java code in the Full Code window. To fix errors that you locate in the Full Code window, modify the code in the appropriate code entry tab. You might need to use the Full Code window to view errors caused by adding user code to the full class code for the transformation.

Use the results of the compilation in the Output window to identify errors in the following locations:

- Code entry tabs
- Full Code window

Locating Errors in the Code Entry Tabs

To locate the source of an error in the code entry tabs, right-click on the error in the Output window and choose View error in snippet or double-click on the error in the Output window. The PowerCenter Client highlights the source of the error in the appropriate code entry tab.

Locating Errors in the Full Code Window

To locate the source of errors in the Full Code window, right-click on the error in the Output window and choose View error in full code or double-click the error in the Output window. The PowerCenter Client highlights the source of the error in the Full Code window.

Identifying the Source of Compilation Errors

Compilation errors can appear as a result of errors in the user code.

Errors in the user code might also generate an error in the non-user code for the class. Compilation errors occur in user and non-user code for the Java transformation.

User Code Errors

Errors can occur in the user code on the code entry tabs. User code errors include standard Java syntax and language errors.

User code errors might also occur when the PowerCenter Client adds the user code from the code entry tabs to the full class code.

For example, a Java transformation has an input port with a name of `int1` and an integer datatype. The full code for the class declares the input port variable with the following code:

```
int int1;
```

However, if you use the same variable name on the **On Input Row** tab, the Java compiler issues an error for a redeclaration of a variable. To fix the error, rename the variable on the **On Input Row** tab.

Non-User Code Errors

User code on the code entry tabs can cause errors in non-user code.

For example, a Java transformation has an input port and an output port, `int1` and `out1`, with integer datatypes. You write the following code in the **On Input Row** code entry tab to calculate interest for input port `int1` and assign it to the output port `out1`:

```
int interest;  
interest = CallInterest(int1); // calculate interest  
out1 = int1 + interest;  
}
```

When you compile the transformation, the PowerCenter Client adds the code from the **On Input Row** code entry tab to the full class code for the transformation. When the Java compiler compiles the Java code, the unmatched brace causes a method in the full class code to end prematurely, and the Java compiler issues an error.

CHAPTER 13

Java Transformation API Reference

This chapter includes the following topics:

- [Java Transformation API Methods Overview, 235](#)
- [commit, 236](#)
- [failSession, 237](#)
- [generateRow, 237](#)
- [getInRowType, 238](#)
- [getMetadata, 238](#)
- [incrementErrorCount, 239](#)
- [isNull, 240](#)
- [logError, 240](#)
- [logInfo, 241](#)
- [rollback, 241](#)
- [setNull, 242](#)
- [setOutRowType, 242](#)
- [storeMetadata, 243](#)

Java Transformation API Methods Overview

On the **Java Code** tab of a Java transformation, you can add API methods to the Java code to define transformation behavior.

To add an API method to the code, expand the **Callable APIs** list in the navigator on the code entry tab, and then double-click the name of the method that you want to add to the code.

Alternatively, you can drag the method from the navigator into the Java code snippet or manually enter the API method in the Java code snippet.

You can add the following API methods to the Java code in a Java transformation:

commit

Generates a transaction.

failSession

Throws an exception with an error message and fails the session.

generateRow

Generates an output row for active Java transformations.

getInRowType

Returns the input type of the current row in the transformation.

incrementErrorCount

Increments the error count for the session.

isNull

Checks for a null value in an input column.

logError

Writes an error message to the session log.

logInfo

Writes an informational message to the session log.

rollback

Generates a rollback transaction.

setNull

Sets the value of an output column in an active or passive Java transformation to null.

setOutRowType

Sets the update strategy for output rows. Can flag rows for insert, update, or delete.

commit

Generates a transaction.

Use `commit` in any tab except the Import Packages or Java Expressions code entry tabs. You can only use `commit` in active transformations configured to generate transactions. If you use `commit` in an active transformation not configured to generate transactions, the Integration Service throws an error and fails the session.

Use the following syntax:

```
commit();
```

Use the following Java code to generate a transaction for every 100 rows processed by a Java transformation and then set the `rowsProcessed` counter to 0:

```
if (rowsProcessed==100) {  
    commit();  
    rowsProcessed=0;  
}
```

failSession

Throws an exception with an error message and fails the session.

Use the following syntax:

```
failSession(String errorMessage);
```

The following table describes the parameter:

Parameter	Parameter Type	Datatype	Description
errorMessage	Input	String	Error message string.

Use the failSession method to end the session. Do not use the failSession method in a try/catch block on a code entry tab.

You can add the failSession method to the Java code on any code entry tab except the **Import Packages** and **Java Expressions** tabs.

The following Java code shows how to test the input1 input port for a null value and fail the session if it is null:

```
if(isNull("input1")) {  
    failSession("Cannot process a null value for port input1.");  
}
```

generateRow

Generates an output row for active Java transformations.

Use the following syntax:

```
generateRow();
```

When you call the generateRow method, the Java transformation generates an output row using the current value of the output port variables. If you want to generate multiple rows corresponding to an input row, you can call the generateRow method more than once for each input row. If you do not use the generateRow method in an active Java transformation, the transformation does not generate output rows.

You can add the generateRow method to the Java code on any code entry tab except the **Import Packages** and **Java Expressions** tabs.

You can call the generateRow method in active transformations only. If you call the generateRow method in a passive transformation, the session generates an error.

Use the following Java code to generate one output row, modify the values of the output ports, and generate another output row:

```
// Generate multiple rows.  
if(!isNull("input1") && !isNull("input2"))  
{  
    output1 = input1 + input2;  
    output2 = input1 - input2;  
}  
generateRow();  
// Generate another row with modified values.  
output1 = output1 * 2;
```

```
output2 = output2 * 2;
generateRow();
```

getInRowType

Returns the input type of the current row in the transformation. The method returns a value of insert, update, delete, or reject.

Use the following syntax:

```
rowType getInRowType();
```

The following table describes the parameter:

Parameter	Parameter Type	Datatype	Description
rowType	Output	String	Returns the update strategy type, which is one of the following values: <ul style="list-style-type: none">- DELETE- INSERT- REJECT- UPDATE

You can add the `getInRowType` method to the Java code on the **On Input Row** code entry tab.

You can use the `getInRowType` method in active transformations configured to set the update strategy. If you call this method in an active transformation that is not configured to set the update strategy, the session generates an error.

Use the following Java code to complete the following actions:

- Propagate the current input row type to the output row.
- If the value of the input1 input port is greater than 100, set the output row type to DELETE.

```
// Set the value of the output port.
output1 = input1;
// Get and set the row type.
String rowType = getInRowType();
setOutRowType(rowType);
// Set row type to DELETE if the output port value is > 100.
if(input1 > 100
    setOutRowType(DELETE);
```

getMetadata

Retrieves Java transformation metadata at runtime. The `getMetadata` method retrieves metadata that you save with the `storeMetadata` method, such as a filter condition that the optimizer passes to the Java transformation in the `pushFilter` function.

Use the following syntax:

```
getMetadata (String key);
```

The following table describes the parameters:

Parameter	Parameter Type	Datatype	Description
key	Input	String	Identifies the metadata. The getMetadata method uses the key to determine which metadata to retrieve.

You can add the getMetadata method to the Java code on the following code entry tabs:

- Helper
- On Input
- At End
- Optimizer Interfaces
- Functions

You can configure the getMetadata method to retrieve filter conditions for push-into optimization. The getMetadata method can retrieve each filter condition that you store from the optimizer.

```
// Retrieve a filter condition
String mydata = getMetadata ("FilterKey");
```

incrementErrorCount

Increments the error count for the session. If the error count reaches the error threshold for the session, the session fails.

Use the following syntax:

```
incrementErrorCount(int nErrors);
```

The following table describes the parameter:

Parameter	Parameter Type	Datatype	Description
nErrors	Input	Integer	Number by which to increment the error count for the session.

You can add the incrementErrorCount method to the Java code on any code entry tab except the **Import Packages** and **Java Expressions** tabs.

The following Java code shows how to increment the error count if an input port for a transformation has a null value:

```
// Check if input employee id and name is null.
if (isNull ("EMP_ID_INP") || isNull ("EMP_NAME_INP"))
{
    incrementErrorCount(1);
    // if input employee id and/or name is null, don't generate a output row for this
    input row
    generateRow = false;
}
```

isNull

Checks the value of an input column for a null value.

Use the following syntax:

```
Boolean isNull(String strColName);
```

The following table describes the parameter:

Parameters	Parameter Type	Datatype	Description
strColName	Input	String	Name of an input column.

You can add the isNull method to the Java code on the **On Input Row** code entry tab.

The following Java code shows how to check whether the value of the SALARY input column is null before adding it to the totalSalaries instance variable:

```
// if value of SALARY is not null
if (!isNull("SALARY")) {
    // add to totalSalaries
    TOTAL_SALARIES += SALARY;
}
```

Alternatively, use the following Java code to achieve the same results:

```
// if value of SALARY is not null
String strColName = "SALARY";
if (!isNull(strColName)) {
    // add to totalSalaries
    TOTAL_SALARIES += SALARY;
}
```

logError

Writes an error message to the session log.

Use the following syntax:

```
logError(String msg);
```

The following table describes the parameter:

Parameter	Parameter Type	Datatype	Description
msg	Input	String	Error message string.

You can add the logError method to the Java code on any code entry tab except the **Import Packages** and **Java Expressions** tabs.

The following Java code shows how to log an error when the input port is null:

```
// check BASE_SALARY
if (isNull("BASE_SALARY")) {
    logError("Cannot process a null salary field.");
}
```

When the code runs, the following message appears in the session log:

```
[JTX_1013] [ERROR] Cannot process a null salary field.
```

logInfo

Writes an informational message to the session log.

Use the following syntax:

```
logInfo(String msg);
```

The following table describes the parameter:

Parameter	Parameter Type	Datatype	Description
msg	Input	String	Information message string.

You can add the logInfo method to the Java code on any code entry tab except the **Import Packages** and **Java Expressions** tabs.

The following Java code shows how to write a message to the session log after the Java transformation processes a message threshold of 1000 rows:

```
if (numRowsProcessed == messageThreshold) {  
    logInfo("Processed " + messageThreshold + " rows.");  
}
```

rollback

Generates a rollback transaction.

Use rollback in any tab except the Import Packages or Java Expressions code entry tabs. You can only use rollback in active transformations configured to generate transactions. If you use rollback in an active transformation not configured to generate transactions, the Integration Service generates an error and fails the session.

Use the following syntax:

```
rollback();
```

Use the following code to generate a rollback transaction and fail the session if an input row has an illegal condition or generate a transaction if the number of rows processed is 100:

```
// If row is not legal, rollback and fail session.  
if (!isRowLegal()) {  
    rollback();  
    failSession("Cannot process illegal row.");  
} else if (rowsProcessed==100) {  
    commit();  
    rowsProcessed=0;  
}
```

setNull

Sets the value of an output column to null in an active or passive Java transformation.

Use the following syntax:

```
setNull(String strColName);
```

The following table describes the parameter:

Parameter	Parameter Type	Datatype	Description
strColName	Input	String	Name of an output column.

The setNull method sets the value of an output column in an active or passive Java transformation to null. After you set an output column to null, you cannot modify the value until you generate an output row.

You can add the setNull method to the Java code on any code entry tab except the **Import Packages** and **Java Expressions** tabs.

The following Java code shows how to check the value of an input column and set the corresponding value of an output column to null:

```
// check value of Q3RESULTS input column
if(isNull("Q3RESULTS")) {
    // set the value of output column to null
    setNull("RESULTS");
}
```

Alternatively, you can use the following Java code achieve the same results:

```
// check value of Q3RESULTS input column
String strColName = "Q3RESULTS";
if(isNull(strColName)) {
    // set the value of output column to null
    setNull(strColName);
}
```

setOutRowType

Sets the update strategy for output rows. The setOutRowType method can flag rows for insert, update, or delete.

You can only use setOutRowType in the On Input Row code entry tab. You can only use setOutRowType in active transformations configured to set the update strategy. If you use setOutRowType in an active transformation not configured to set the update strategy, the session generates an error and the session fails.

Use the following syntax:

```
setOutRowType(String rowType);
```

The following table describes the argument for this method:

Argument	Datatype	Input/Output	Description
rowType	String	Input	Update strategy type. Value can be INSERT, UPDATE, or DELETE.

Use the following Java code to propagate the input type of the current row if the row type is UPDATE or INSERT and the value of the input port input1 is less than 100 or set the output type as DELETE if the value of input1 is greater than 100:

```
// Set the value of the output port.
output1 = input1;

// Get and set the row type.
String rowType = getInRowType();
setOutRowType(rowType);

// Set row type to DELETE if the output port value is > 100.
if(input1 > 100)
    setOutRowType(DELETE);
```

storeMetadata

Stores Java transformation metadata that you can retrieve at runtime with the getMetadata method.

Use the following syntax:

```
storeMetadata (String key String data);
```

The following table describes the parameters:

Parameter	Parameter Type	Datatype	Description
key	Input	String	Identifies the metadata. The storeMetadata method requires a key to identify the metadata. Define the key as any string.
data	Input	String	The data that you want to store as Java transformation metadata.

You can add the storeMetadata method to the Java code to the following code entry tabs:

- Helper
- On Input
- At End
- Optimizer Interfaces
- Functions

You can configure the `storeMetadata` method in an active transformation to accept filter conditions for push-into optimization. The `storeMetadata` method stores a filter condition that the optimizer pushes from the mapping to the Java transformation.

```
// Store a filter condition
storeMetadata ("FilterKey", condition);
```

CHAPTER 14

Java Expressions

This chapter includes the following topics:

- [Java Expressions Overview, 245](#)
- [Using the Define Expression Dialog Box to Define an Expression, 246](#)
- [Working with the Simple Interface, 248](#)
- [Working with the Advanced Interface, 250](#)
- [JExpression Class API Reference, 254](#)

Java Expressions Overview

You can invoke PowerCenter expressions in a Java transformation with the Java programming language.

Use expressions to extend the functionality of a Java transformation. For example, you can invoke an expression in a Java transformation to look up the values of input or output ports or look up the values of Java transformation variables.

To invoke expressions in a Java transformation, you generate the Java code or use Java transformation API methods to invoke the expression. You invoke the expression and use the result of the expression on the appropriate code entry tab. You can generate the Java code that invokes an expression or use API methods to write the Java code that invokes the expression.

The following table describes the methods that you can use to create and invoke expressions in a Java transformation:

Method	Description
Define Expression dialog box	Enables you to create an expression and generate the code for an expression.
Simple interface	Enables you to call a single API method to invoke an expression and get the result of the expression.
Advanced interface	Enables you to define the expression, invoke the expression, and use the result of the expression. If you are familiar with object-oriented programming and want more control over invoking the expression, use the advanced interface.

Expression Function Types

You can create expressions for a Java transformation by using the **Expression Editor**, by writing the expression in the **Define Expression** dialog box, or by using the simple or advanced interface.

You can enter expressions that use input or output port variables or variables in the Java code as input parameters.

If you use the **Define Expression** dialog box, you can use the **Expression Editor** to validate the expression before you use it in a Java transformation.

You can invoke the following types of expression functions in a Java transformation:

Expression Function Type	Description
Transformation language functions	SQL-like functions designed to handle common expressions.
User-defined functions	Functions that you create in PowerCenter based on transformation language functions.
Custom functions	Functions that you create with the Custom Function API.

You can also use unconnected transformations, built-in variables, user-defined mapping and workflow variables, and pre-defined workflow variables in expressions. For example, you can use an unconnected lookup transformation in an expression.

Using the Define Expression Dialog Box to Define an Expression

When you define a Java expression, you configure the function, create the expression, and generate the code that invokes the expression.

You can define the function and create the expression in the **Define Expression** dialog box.

To create an expression function and use the expression in a Java transformation, complete the following high-level tasks:

1. Configure the function that invokes the expression, including the function name, description, and parameters. You use the function parameters when you create the expression.
2. Create the expression syntax and validate the expression.
3. Generate the Java code that invokes the expression.

The Designer places the code on the **Java Expressions** code entry tab in the Transformation Developer.

After you generate the Java code, call the generated function on the appropriate code entry tab to invoke an expression or get a JExpression object, based on whether you use the simple or advanced interface.

Note: To validate an expression when you create the expression, you must use the **Define Expression** dialog box.

Step 1. Configure the Function

You configure the function name, description, and input parameters for the Java function that invokes the expression.

Use the following rules and guidelines when you configure the function:

- Use a unique function name that does not conflict with an existing Java function in the transformation or reserved Java keywords.
- You must configure the parameter name, Java datatype, precision, and scale. The input parameters are the values you pass when you call the function in the Java code for the transformation.
- To pass the Date datatype to an expression, use the String datatype for the input parameter.

If an expression returns the Date datatype, you can use the return value as the String datatype in the simple interface and the String or long datatype in the advanced interface.

Step 2. Create and Validate the Expression

When you create the expression, use the parameters you configured for the function.

You can also use transformation language functions, custom functions, or other user-defined functions in the expression. You can create and validate the expression in the **Define Expression** dialog box or in the **Expression Editor** dialog box.

Step 3. Generate Java Code for the Expression

After you configure the function and function parameters and define and validate the expression, you can generate the Java code that invokes the expression.

The Designer places the generated Java code on the **Java Expressions** code entry tab. Use the generated Java code to call the functions that invoke the expression in the code entry tabs in the Transformation Developer. You can generate the simple or advanced Java code.

After you generate the Java code that invokes an expression, you cannot edit the expression and revalidate it. To modify an expression after you generate the code, you must create the expression again.

Creating an Expression and Generating Java Code by Using the Define Expression Dialog Box

You can create a function that invokes an expression in the **Define Expression** dialog box.

Complete the following steps to create a function that invokes an expression:

1. In the Transformation Developer, open a Java transformation or create a new Java transformation.
2. On the **Java Code** tab, click the **Define Expression** link.
The **Define Expression** dialog box appears.
3. Enter a function name.
4. Optionally, enter a description for the expression.
Enter up to 2,000 characters.
5. Create the parameters for the function.
When you create the parameters, configure the parameter name, datatype, precision, and scale.
6. Click **Launch Editor** to create an expression with the parameters that you created.
7. To validate the expression, click **Validate**.

8. Optionally, enter the expression in the **Expression** box. Then, click **Validate** to validate the expression.
9. To generate Java code by using the advanced interface, select the **Generate Advanced Code** option. Then, click **Generate**.

The Designer generates the function to invoke the expression on the **Java Expressions** code entry tab.

Java Expression Templates

You can generate Java code for an expression using the simple or advanced Java code for an expression.

The Java code for the expression is generated based on the template for the expression.

The following example shows the template for a Java expression generated for simple Java code:

```
Object function_name (Java datatype x1[,
                        Java datatype x2 ...] )
                        throws SDK Exception
{
    return (Object)invokeJExpression( String expression,
                                     new Object [] { x1[, x2, ... ]} );
}
```

The following example shows the template for a Java expression generated by using the advanced interface:

```
JExpression function_name () throws SDKException
{
    JExprParamMetadata params[] = new JExprParamMetadata[number of parameters];
    params[0] = new JExprParamMetadata (
        EDataType.STRING, // data type
        20, // precision
        0 // scale
    );
    ...
    params[number of parameters - 1] = new JExprParamMetadata (
        EDataType.STRING, // data type
        20, // precision
        0 // scale
    );
    ...
    return defineJExpression(String expression,params);
}
```

Working with the Simple Interface

Use the `invokeJExpression` Java API method to invoke an expression in the simple interface.

`invokeJExpression`

Invokes an expression and returns the value for the expression.

Use the following syntax:

```
(datatype) invokeJExpression(
    String expression,
    Object[] paramMetadataArray);
```

Input parameters for the `invokeJExpression` method are a string value that represents the expression and an array of objects that contain the expression input parameters.

The following table describes the parameters:

Parameter	Parameter Type	Datatype	Description
expression	Input	String	String that represents the expression.
paramMetadataArray	Input	Object[]	Array of objects that contain the input parameters for the expression.

You can add the `invokeJExpression` method to the Java code on any code entry tab except the **Import Packages** and **Java Expressions** tabs.

Use the following rules and guidelines when you use the `invokeJExpression` method:

- **Return datatype.** The return datatype of the `invokeJExpression` method is an object. You must cast the return value of the function with the appropriate datatype.
You can return values with `Integer`, `Double`, `String`, and `byte[]` datatypes.
- **Row type.** The row type for return values from the `invokeJExpression` method is `INSERT`.
To use a different row type for the return value, use the advanced interface.
- **Null values.** If you pass a null value as a parameter or the return value for the `invokeJExpression` method is `NULL`, the value is treated as a null indicator.
For example, if the return value of an expression is `NULL` and the return datatype is `String`, a string is returned with a value of null.
- **Date datatype.** You must convert input parameters with a `Date` datatype to the `String` datatype.
To use the string in an expression as a `Date` datatype, use the `to_date()` function to convert the string to a `Date` datatype.
Also, you must cast the return type of any expression that returns a `Date` datatype as a `String` datatype.

Note: You must number the parameters that you pass to the expression consecutively, and start the parameter with the letter `x`. For example, to pass three parameters to an expression, name the parameters `x1`, `x2`, and `x3`.

Simple Interface Example

You can define and call expressions that use the `invokeJExpression` API method on the **Helper Code** and **On Input Row** code entry tabs.

The following example shows how to complete a lookup on the `NAME` and `ADDRESS` input ports in a Java transformation and assign the return value to the `COMPANY_NAME` output port.

Enter the following code on the **On Input Row** code entry tab:

```
COMPANY_NAME = (String)invokeJExpression(":lkp.my_lookup(X1,X2)", new Object []  
{str1 ,str2} );  
generateRow();
```

Working with the Advanced Interface

In the advanced interface, you can use object oriented API methods to define, invoke, and get the result of an expression.

The following table describes the classes and API methods that are available in the advanced interface:

Class or API Method	Description
EDataType class	Enumerates the datatypes for an expression.
JExprParamMetadata class	Contains the metadata for each parameter in an expression. Parameter metadata includes datatype, precision, and scale.
defineJExpression API method	Defines the expression. Includes PowerCenter expression string and parameters.
invokeJExpression API method	Invokes an expression.
JExpression class	Contains the methods to create, invoke, get the metadata and get the expression result, and check the return datatype.

Invoking an Expression with the Advanced Interface

You can define, invoke, and get the result of an expression by using the advanced interface.

1. On the **Helper Code** or **On Input Row** code entry tab, create an instance of JExprParamMetadata class for each parameter for the expression and set the value of the metadata. Optionally, you can instantiate the JExprParamMetadata object in the defineJExpression method.
2. Use the defineJExpression method to get the JExpression object for the expression.
3. On the appropriate code entry tab, invoke the expression with the invokeJExpression method.
4. Check the result of the return value with the isResultNull method.
5. You can get the datatype of the return value or the metadata of the return value with the getResultDataType and getResultMetadata methods.
6. Get the result of the expression by using the appropriate API method. You can use the getInt, getDouble, getStringBuffer, and getBytes methods.

Rules and Guidelines for Working with the Advanced Interface

When you work with the advanced interfaces, you must be aware of rules and guidelines.

Use the following rules and guidelines:

- If you pass a null value as a parameter or if the result of an expression is null, the value is treated as a null indicator. For example, if the result of an expression is null and the return datatype is String, a string is returned with a value of null. You can check the result of an expression by using the isResultNull method.

- You must convert input parameters with a Date datatype to a String before you can use them in an expression. To use the string in an expression as a Date datatype, use the `to_date()` function to convert the string to a Date datatype.

You can get the result of an expression that returns a Date datatype as a String or long datatype.

To get the result of an expression that returns a Date datatype as a String datatype, use the `getStringBuffer` method. To get the result of an expression that returns a Date datatype as a long datatype, use the `getLong` method.

EDataType Class

Enumerates the Java datatypes used in expressions. Gets the return datatype of an expression or assign the datatype for a parameter in a `JExprParamMetadata` object. You do not need to instantiate the `EDataType` class.

The following table lists the enumerated values for Java datatypes in expressions:

Datatype	Enumerated Value
INT	1
DOUBLE	2
STRING	3
BYTE_ARRAY	4
DATE_AS_LONG	5

The following example Java code shows how to use the `EDataType` class to assign a datatype of String to a `JExprParamMetadata` object:

```
JExprParamMetadata params[] = new JExprParamMetadata[2];
params[0] = new JExprParamMetadata (
    EDataType.STRING, // data type
    20, // precision
    0 // scale
);
...

```

JExprParamMetadata Class

Instantiates an object that represents the parameters for an expression and sets the metadata for the parameters.

You use an array of `JExprParamMetadata` objects as input to the `defineJExpression` method to set the metadata for the input parameters. You can create an instance of the `JExprParamMetadata` object on the **Java Expressions** code entry tab or in `defineJExpression`.

Use the following syntax:

```
JExprParamMetadata paramMetadataArray[] = new JExprParamMetadata[numberOfParameters];
paramMetadataArray[0] = new JExprParamMetadata(datatype, precision, scale);
...
paramMetadataArray[numberOfParameters - 1] = new JExprParamMetadata(datatype, precision,
scale);;
```

The following table describes the arguments:

Argument	Argument Type	Argument Datatype	Description
datatype	Input	EDatatype	Datatype of the parameter.
precision	Input	Integer	Precision of the parameter.
scale	Input	Integer	Scale of the parameter.

For example, use the following Java code to instantiate an array of two JExprParamMetadata objects with String datatypes, precision of 20, and scale of 0:

```
JExprParamMetadata params[] = new JExprParamMetadata[2];
params[0] = new JExprParamMetadata(EDatatype.STRING, 20, 0);
params[1] = new JExprParamMetadata(EDatatype.STRING, 20, 0);
return defineJExpression(":LKP.LKP_addresslookup(X1,X2)",params);
```

defineJExpression

Defines an expression, including the expression string and input parameters. Arguments for the defineJExpression method include an array of JExprParamMetadata objects that contains the input parameters and a string value that defines the expression syntax.

Use the following syntax:

```
defineJExpression(
    String expression,
    Object[] paramMetadataArray
);
```

The following table describes the parameters:

Parameter	Type	Datatype	Description
expression	Input	String	String that represents the expression.
paramMetadataArray	Input	Object[]	Array of JExprParamMetadata objects that contain the input parameters for the expression.

To use the defineJExpression method, you must instantiate an array of JExprParamMetadata objects that represent the input parameters for the expression. You set the metadata values for the parameters and pass the array as a parameter to the defineJExpression method.

For example, the following Java code creates an expression to look up the value of two strings:

```
JExprParamMetadata params[] = new JExprParamMetadata[2];
params[0] = new JExprParamMetadata(EDatatype.STRING, 20, 0);
params[1] = new JExprParamMetadata(EDatatype.STRING, 20, 0);
defineJExpression(":lkp.mylookup(x1,x2)",params);
```

Note: You must number the parameters that you pass to the expression consecutively and start the parameters with the letter x. For example, to pass three parameters to an expression, name the parameters x1, x2, and x3.

JExpression Class

Contains methods to create and invoke an expression, return the value of an expression, and check the return datatype.

The following table lists the methods in the JExpression class:

Method Name	Description
invoke	Invokes an expression.
getResultDataType	Returns the datatype of the expression result.
getResultMetadata	Returns the metadata of the expression result.
isResultNull	Checks the result value of an expression result.
getInt	Returns the value of an expression result as an Integer datatype.
getDouble	Returns the value of an expression result as a Double datatype.
getStringBuffer	Returns the value of an expression result as a String datatype.
getBytes	Returns the value of an expression result as a byte[] datatype.

RELATED TOPICS:

- [“JExpression Class API Reference” on page 254](#)

Advanced Interface Example

You can use the advanced interface to create and invoke a lookup expression in a Java transformation.

The following example Java code shows how to create a function that calls an expression and how to invoke the expression to get the return value. This example passes the values for two input ports with a String datatype, NAME and COMPANY, to the function myLookup. The myLookup function uses a lookup expression to look up the value for the ADDRESS output port.

Note: This example assumes you have an unconnected lookup transformation in the mapping called LKP_addresslookup.

Use the following Java code on the **Helper Code** tab of the Transformation Developer:

```
JExpression addressLookup() throws SDKException
{
    JExprParamMetadata params[] = new JExprParamMetadata[2];
    params[0] = new JExprParamMetadata (
        EDataType.STRING,           // data type
        50,                         // precision
        0                           // scale
    );
    params[1] = new JExprParamMetadata (
        EDataType.STRING,           // data type
        50,                         // precision
        0                           // scale
    );
    return defineJExpression(":LKP.LKP_addresslookup(X1,X2)", params);
}
JExpression lookup = null;
boolean isJExprObjCreated = false;
```

Use the following Java code on the **On Input Row** tab to invoke the expression and return the value of the ADDRESS port:

```
...
if(!iisJExprObjCreated)
{
    lookup = addressLookup();
    isJExprObjCreated = true;
}
lookup = addressLookup();
lookup.invoke(new Object [] {NAME,COMPANY}, ERowType.INSERT);
EDatatype addressDataType = lookup.getResultDataType();
if(addressDataType == EDatatype.STRING)
{
    ADDRESS = (lookup.getStringBuffer()).toString();
} else {
    logError("Expression result datatype is incorrect.");
}
...

```

JExpression Class API Reference

The JExpression class contains API methods that let you create and invoke an expression, return the value of an expression, and check the return datatype.

The JExpression class contains the following API methods:

- `getBytes`
- `getDouble`
- `getInt`
- `getLong`
- `getResultDataType`
- `getResultMetadata`
- `getStringBuffer`
- `invoke`
- `isResultNull`

getBytes

Returns the value of an expression result as a `byte[]` datatype. Gets the result of an expression that encrypts data with the AES_ENCRYPT function.

Use the following syntax:

```
objectName.getBytes();
```

Use the following example Java code to get the result of an expression that encrypts the binary data using the AES_ENCRYPT function, where `JExprEncryptData` is a `JExpression` object:

```
byte[] newBytes = JExprEncryptData.getBytes();
```

getDouble

Returns the value of an expression result as a Double datatype.

Use the following syntax:

```
objectName.getDouble();
```

Use the following example Java code to get the result of an expression that returns a salary value as a double, where JExprSalary is a JExpression object:

```
double salary = JExprSalary.getDouble();
```

getInt

Returns the value of an expression result as an Integer datatype.

Use the following syntax:

```
objectName.getInt();
```

For example, use the following Java code to get the result of an expression that returns an employee ID number as an integer, where findEmpID is a JExpression object:

```
int empID = findEmpID.getInt();
```

getLong

Returns the value of an expression result as a Long datatype. Gets the result of an expression that uses a Date datatype.

Use the following syntax:

```
objectName.getLong();
```

Use the following example Java code to get the result of an expression that returns a Date value as a Long datatype, where JExprCurrentDate is a JExpression object:

```
long currDate = JExprCurrentDate.getLong();
```

getResultDataType

Returns the datatype of an expression result. Returns a value of EDataType.

Use the following syntax:

```
objectName.getResultDataType();
```

Use the following example Java code to invoke an expression and assign the datatype of the result to the variable dataType:

```
myObject.invoke(new Object[] { NAME,COMPANY }, ERowType INSERT);  
EDataType dataType = myObject.getResultDataType();
```

getResultMetadata

Returns the metadata for an expression result. You can use getResultMetadata to get the precision, scale, and datatype of an expression result. You can assign the metadata of the return value from an expression to a JExprParamMetadata object. Use the getScale, getPrecision, and getDataType object methods to retrieve the result metadata.

Use the following syntax:

```
objectName.getResultMetadata();
```

Use the following example Java code to assign the scale, precision, and datatype of the return value of `myObject` to variables:

```
JExprParamMetadata myMetadata = myObject.getResultMetadata();
int scale = myMetadata.getScale();
int prec = myMetadata.getPrecision();
int datatype = myMetadata.getDataType();
```

Note: The `getDataType` object method returns the integer value of the datatype, as enumerated in `EDataType`.

getStringBuffer

Returns the value of an expression result as a String datatype.

Use the following syntax:

```
objectName.getStringBuffer();
```

Use the following example Java code to get the result of an expression that returns two concatenated strings, where `JExprConcat` is an `JExpression` object:

```
String result = JExprConcat.getStringBuffer();
```

invoke

Invokes an expression. Arguments for `invoke` include an object that defines the input parameters and the row type. You must instantiate a `JExpression` object before you can use the `invoke` method. For the row type, use `ERowType.INSERT`, `ERowType.DELETE`, and `ERowType.UPDATE`.

Use the following syntax:

```
objectName.invoke(
    new Object[] { param1[, ... paramN ]},
    rowType
);
```

The following table describes the arguments:

Argument	Datatype	Input/Output	Description
<code>objectName</code>	<code>JExpression</code>	Input	<code>JExpression</code> object name.
<code>parameters</code>	-	Input	Object array that contains the input values for the expression.

For example, you create a function on the **Java Expressions** code entry tab named `address_lookup()` that returns an `JExpression` object that represents the expression. Use the following code to invoke the expression that uses input ports `NAME` and `COMPANY`:

```
JExpression myObject = address_lookup();
myObject.invoke(new Object[] { NAME, COMPANY }, ERowType.INSERT);
```

isResultNull

Checks the value of an expression result.

Use the following syntax:

```
objectName.isResultNull();
```

Use the following example Java code to invoke an expression and assign the return value of the expression to the variable address if the return value is not null:

```
JExpression myObject = address_lookup();
myObject.invoke(new Object[] { NAME,COMPANY }, ERowType INSERT);
if(!myObject.isResultNull()) {
    String address = myObject.getStringBuffer();
}
```

CHAPTER 15

Java Transformation Example

This chapter includes the following topics:

- [Java Transformation Example Overview, 258](#)
- [Step 1. Import the Mapping, 259](#)
- [Step 2. Create Transformation and Configure Ports, 259](#)
- [Step 3. Enter Java Code, 260](#)
- [Import Packages Tab, 260](#)
- [Helper Code Tab, 261](#)
- [On Input Row Tab, 261](#)
- [Step 4. Compile the Java Code, 263](#)
- [Step 5. Create a Session and Workflow, 263](#)

Java Transformation Example Overview

You can use the Java code in this example to create and compile an active Java transformation. You import a sample mapping and create and compile the Java transformation. You can then create and run a session and workflow that contains the mapping.

The Java transformation processes employee data for a fictional company. It reads input rows from a flat file source and writes output rows to a flat file target. The source file contains employee data, including the employee identification number, name, job title, and the manager identification number.

The transformation finds the manager name for a given employee based on the manager identification number and generates output rows that contain employee data. The output data includes the employee identification number, name, job title, and the name of the employee's manager. If the employee has no manager in the source data, the transformation assumes the employee is at the top of the hierarchy in the company organizational chart.

Note: The transformation logic assumes the employee job titles are arranged in descending order in the source file.

Complete the following steps to import the sample mapping, create and compile a Java transformation, and create a session and workflow that contains the mapping:

1. Import the sample mapping.
2. Create the Java transformation and configure the Java transformation ports.
3. Enter the Java code for the transformation in the appropriate code entry tabs.

4. Compile the Java code.
5. Create and run a session and workflow.

The PowerCenter Client installation contains a mapping, m_jtx_hier_useCase.xml, and flat file source, hier_data, that you can use with this example.

RELATED TOPICS:

- [“Java Transformation” on page 219](#)

Step 1. Import the Mapping

Import the metadata for the sample mapping in the Designer. The sample mapping contains the following components:

- **Source definition and Source Qualifier transformation.** Flat file source definition, hier_input, that defines the source data for the transformation.
- **Target definition.** Flat file target definition, hier_data, that receives the output data from the transformation.

You can import the metadata for the mapping from the following location:

```
<PowerCenter Client installation directory>\client\bin\m_jtx_hier_useCase.xml
```

The following figure shows the sample mapping:

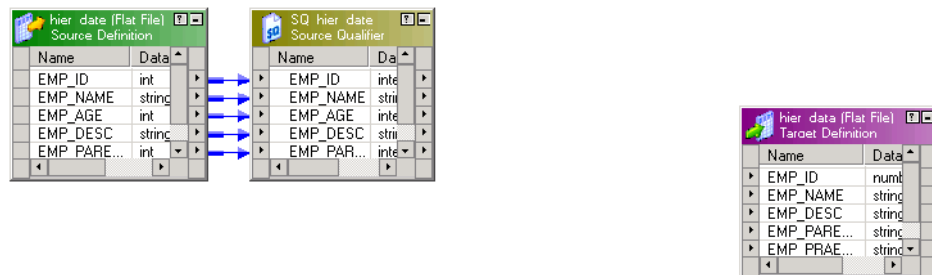

Step 2. Create Transformation and Configure Ports

You create the Java transformation and configure the ports in the Mapping Designer. You can use the input and output port names as variables in the Java code. In a Java transformation, you create input and output ports in an input or output group. A Java transformation may contain only one input group and one output group.

In the Mapping Designer, create an active Java transformation and configure the ports. In this example, the transformation is named jtx_hier_useCase.

Note: To use the Java code in this example, you must use the exact names for the input and output ports.

The following table shows the input and output ports for the transformation:

Port Name	Port Type	Datatype	Precision	Scale
EMP_ID_INP	Input	Integer	10	0
EMP_NAME_INP	Input	String	100	0
EMP_AGE	Input	Integer	10	0
EMP_DESC_INP	Input	String	100	0
EMP_PARENT_EMPID	Input	Integer	10	0
EMP_ID_OUT	Output	Integer	10	0
EMP_NAME_OUT	Output	String	100	0
EMP_DESC_OUT	Output	String	100	0
EMP_PARENT_EMPNAME	Output	String	100	0

Step 3. Enter Java Code

Enter Java code for the transformation in the following code entry tabs:

- **Import Packages.** Imports the `java.util.Map` and `java.util.HashMap` packages.
- **Helper Code.** Contains a Map object, lock object, and boolean variables used to track the state of data in the Java transformation.
- **On Input Row.** Defines the behavior of the Java transformation when it receives an input row.

Import Packages Tab

Import third-party Java packages, built-in Java packages, or custom Java packages in the Import Packages tab. The example transformation uses the Map and HashMap packages.

Enter the following code in the Import Packages tab:

```
import java.util.Map;
import java.util.HashMap;
```

The Designer adds the import statements to the Java code for the transformation.

RELATED TOPICS:

- [“Configuring Java Transformation Settings” on page 230](#)

Helper Code Tab

Declare user-defined variables and methods for the Java transformation on the Helper Code tab. The Helper Code tab defines the following variables that are used by the Java code in the On Input Row tab:

- **empMap**. Map object that stores the identification number and employee name from the source.
- **lock**. Lock object used to synchronize the access to empMap across partitions.
- **generateRow**. Boolean variable used to determine if an output row should be generated for the current input row.
- **isRoot**. Boolean variable used to determine if an employee is at the top of the company organizational chart (root).

Enter the following code in the Helper Code tab:

```
// Static Map object to store the ID and name relationship of an
// employee. If a session uses multiple partitions, empMap is shared
// across all partitions.
private static Map <Integer, String> empMap = new HashMap <Integer, String> ();
// Static lock object to synchronize the access to empMap across
// partitions.
private static Object lock = new Object();
// Boolean to track whether to generate an output row based on validity
// of the input data.
private boolean generateRow;
// Boolean to track whether the employee is root.
private boolean isRoot;
```

On Input Row Tab

The Java transformation executes the Java code in the On Input Row tab when the transformation receives an input row. In this example, the transformation may or may not generate an output row, based on the values of the input row.

Enter the following code in the On Input Row tab:

```
// Initially set generateRow to true for each input row.
generateRow = true;
// Initially set isRoot to false for each input row.
isRoot = false;
```

```

// Check if input employee id and name is null.
if (isNull ("EMP_ID_INP") || isNull ("EMP_NAME_INP"))
{
    incrementErrorCount(1);
    // If input employee id and/or name is null, don't generate a output
    // row for this input row.
    generateRow = false;
} else {
    // Set the output port values.
    EMP_ID_OUT = EMP_ID_INP;
    EMP_NAME_OUT = EMP_NAME_INP;
}

if (isNull ("EMP_DESC_INP"))
{
    setNull("EMP_DESC_OUT");
} else {
    EMP_DESC_OUT = EMP_DESC_INP;
}

boolean isParentEmpIdNull = isNull("EMP_PARENT_EMPID");

if(isParentEmpIdNull)
{
    // This employee is the root for the hierarchy.
    isRoot = true;
    logInfo("This is the root for this hierarchy.");
    setNull("EMP_PARENT_EMPNAME");
}

synchronized(lock)
{
    // If the employee is not the root for this hierarchy, get the
    // corresponding parent id.
    if(!isParentEmpIdNull)
        EMP_PARENT_EMPNAME = (String) (empMap.get(new Integer (EMP_PARENT_EMPID)));
    // Add employee to the map for future reference.
    empMap.put (new Integer(EMP_ID_INP), EMP_NAME_INP);
}

```

```
}

// Generate row if generateRow is true.
if(generateRow)
    generateRow();
```

Step 4. Compile the Java Code

Click Compile in the Transformation Developer to compile the Java code for the transformation. The Output window displays the status of the compilation. If the Java code does not compile successfully, correct the errors in the code entry tabs and recompile the Java code. After you successfully compile the transformation, save the transformation to the repository.

RELATED TOPICS:

- [“Compiling a Java Transformation” on page 232](#)
- [“Fixing Compilation Errors” on page 233](#)

Step 5. Create a Session and Workflow

Create a session and workflow for the mapping in the Workflow Manager, using the m_jtx_hier_useCase mapping.

When you configure the session, you can use the sample source file from the following location:

```
<PowerCenter Client installation directory>\client\bin\hier_data
```

Sample Data

The following data is an excerpt from the sample source file:

```
1,James Davis,50,CEO,
4,Elaine Masters,40,Vice President - Sales,1
5,Naresh Thiagarajan,40,Vice President - HR,1
6,Jeanne Williams,40,Vice President - Software,1
9,Geetha Manjunath,34,Senior HR Manager,5
10,Dan Thomas,32,Senior Software Manager,6
14,Shankar Rahul,34,Senior Software Manager,6
20,Juan Cardenas,32,Technical Lead,10
21,Pramodh Rahman,36,Lead Engineer,14
22,Sandra Patterson,24,Software Engineer,10
23,Tom Kelly,32,Lead Engineer,10
```

35,Betty Johnson,27,Lead Engineer,14
50,Dave Chu,26,Software Engineer,23
70,Srihari Giran,23,Software Engineer,35
71,Frank Smalls,24,Software Engineer,35

The following data is an excerpt from a sample target file:

1,James Davis,CEO,
4,Elaine Masters,Vice President - Sales,James Davis
5,Naresh Thiagarajan,Vice President - HR,James Davis
6,Jeanne Williams,Vice President - Software,James Davis
9,Geetha Manjunath,Senior HR Manager,Naresh Thiagarajan
10,Dan Thomas,Senior Software Manager,Jeanne Williams
14,Shankar Rahul,Senior Software Manager,Jeanne Williams
20,Juan Cardenas,Technical Lead,Dan Thomas
21,Pramodh Rahman,Lead Engineer,Shankar Rahul
22,Sandra Patterson,Software Engineer,Dan Thomas
23,Tom Kelly,Lead Engineer,Dan Thomas
35,Betty Johnson,Lead Engineer,Shankar Rahul
50,Dave Chu,Software Engineer,Tom Kelly
70,Srihari Giran,Software Engineer,Betty Johnson
71,Frank Smalls,Software Engineer,Betty Johnson

CHAPTER 16

Joiner Transformation

This chapter includes the following topics:

- [Joiner Transformation Overview, 265](#)
- [Joiner Transformation Properties, 266](#)
- [Defining a Join Condition, 267](#)
- [Defining the Join Type, 268](#)
- [Using Sorted Input, 270](#)
- [Joining Data from a Single Source, 273](#)
- [Blocking the Source Pipelines, 275](#)
- [Working with Transactions, 275](#)
- [Creating a Joiner Transformation, 277](#)
- [Tips for Joiner Transformations, 278](#)

Joiner Transformation Overview

Use the Joiner transformation to join source data from two related heterogeneous sources residing in different locations or file systems. You can also join data from the same source. The Joiner transformation joins sources with at least one matching column. The Joiner transformation uses a condition that matches one or more pairs of columns between the two sources. The Joiner transformation is an active transformation.

The two input pipelines include a master pipeline and a detail pipeline or a master and a detail branch. The master pipeline ends at the Joiner transformation, while the detail pipeline continues to the target.

To join more than two sources in a mapping, join the output from the Joiner transformation with another source pipeline. Add Joiner transformations to the mapping until you have joined all the source pipelines.

The Joiner transformation accepts input from most transformations. However, consider the following limitations on the pipelines you connect to the Joiner transformation:

- You cannot use a Joiner transformation when either input pipeline contains an Update Strategy transformation.
- You cannot use a Joiner transformation if you connect a Sequence Generator transformation directly before the Joiner transformation.

Working with the Joiner Transformation

When you work with the Joiner transformation, you must configure the transformation properties, join type, and join condition. You can configure the Joiner transformation for sorted input to improve Integration Service performance. You can also configure the transformation scope to control how the Integration Service applies transformation logic. To work with the Joiner transformation, complete the following tasks:

- **Configure the Joiner transformation properties.** Properties for the Joiner transformation identify the location of the cache directory, how the Integration Service processes the transformation, and how the Integration Service handles caching.
- **Configure the join condition.** The join condition contains ports from both input sources that must match for the Integration Service to join two rows. Depending on the type of join selected, the Integration Service either adds the row to the result set or discards the row.
- **Configure the join type.** A join is a relational operator that combines data from multiple tables in different databases or flat files into a single result set. You can configure the Joiner transformation to use a Normal, Master Outer, Detail Outer, or Full Outer join type.
- **Configure the session for sorted or unsorted input.** You can improve session performance by configuring the Joiner transformation to use sorted input. To configure a mapping to use sorted data, you establish and maintain a sort order in the mapping so that the Integration Service can use the sorted data when it processes the Joiner transformation.
- **Configure the transaction scope.** When the Integration Service processes a Joiner transformation, it can apply transformation logic to all data in a transaction, all incoming data, or one row of data at a time.

If you have the partitioning option in PowerCenter, you can increase the number of partitions in a pipeline to improve session performance.

Joiner Transformation Properties

Properties for the Joiner transformation identify the location of the cache directory, how the Integration Service processes the transformation, and how the Integration Service handles caching. The properties also determine how the Integration Service joins tables and files.

When you create a mapping, you specify the properties for each Joiner transformation. When you create a session, you can override some properties, such as the index and data cache size for each transformation.

The following table describes the Joiner transformation properties:

Option	Description
Cache Directory	Specifies the directory used to cache master or detail rows and the index to these rows. By default, the cache files are created in a directory specified by the process variable \$PMCacheDir. If you override the directory, make sure the directory exists and contains enough disk space for the cache files. The directory can be a mapped or mounted drive.
Join Type	Specifies the type of join: Normal, Master Outer, Detail Outer, or Full Outer.
Null Ordering in Master	Not applicable for this transformation type.
Null Ordering in Detail	Not applicable for this transformation type.

Option	Description
Tracing Level	Amount of detail displayed in the session log for this transformation. The options are Terse, Normal, Verbose Data, and Verbose Initialization.
Joiner Data Cache Size	Data cache size for the transformation. Default cache size is 2,000,000 bytes. If the total configured cache size is 2 GB or more, you must run the session on a 64-bit Integration Service. You can use a numeric value for the cache, you can use a cache value from a parameter file or you can configure the Integration Service to set the cache size by using the Auto setting. If you configure the Integration Service to determine the cache size, you can also configure a maximum amount of memory for the Integration Service to allocate to the cache.
Joiner Index Cache Size	Index cache size for the transformation. Default cache size is 1,000,000 bytes. If the total configured cache size is 2 GB or more, you must run the session on a 64-bit Integration Service. You can use a numeric value for the cache, you can use a cache value from a parameter file or you can configure the Integration Service to set the cache size by using the Auto setting. If you configure the Integration Service to determine the cache size, you can also configure a maximum amount of memory for the Integration Service to allocate to the cache.
Sorted Input	Specifies that data is sorted. Choose Sorted Input to join sorted data. Using sorted input can improve performance.
Master Sort Order	Specifies the sort order of the master source data. Choose Ascending if the master source data is in ascending order. If you choose Ascending, also enable sorted input. Default is Auto.
Transformation Scope	Specifies how the Integration Service applies the transformation logic to incoming data. You can choose Transaction, All Input, or Row.

Defining a Join Condition

The join condition contains ports from both input sources that must match for the Integration Service to join two rows. Depending on the type of join selected, the Integration Service either adds the row to the result set or discards the row. The Joiner transformation produces result sets based on the join type, condition, and input data sources.

Before you define a join condition, verify that the master and detail sources are configured for optimal performance. During a session, the Integration Service compares each row of the master source against the detail source. To improve performance for an unsorted Joiner transformation, use the source with fewer rows as the master source. To improve performance for a sorted Joiner transformation, use the source with fewer duplicate key values as the master.

By default, when you add ports to a Joiner transformation, the ports from the first source pipeline display as detail sources. Adding the ports from the second source pipeline sets them as master sources. To change these settings, click the M column on the Ports tab for the ports you want to set as the master source. This sets ports from this source as master ports and ports from the other source as detail ports.

You define one or more conditions based on equality between the specified master and detail sources. For example, if two sources with tables called EMPLOYEE_AGE and EMPLOYEE_POSITION both contain employee ID numbers, the following condition matches rows with employees listed in both sources:

```
EMP_ID1 = EMP_ID2
```

Use one or more ports from the input sources of a Joiner transformation in the join condition. Additional ports increase the time necessary to join two sources. The order of the ports in the condition can impact the performance of the Joiner transformation. If you use multiple ports in the join condition, the Integration Service compares the ports in the order you specify.

The Designer validates datatypes in a condition. Both ports in a condition must have the same datatype. If you need to use two ports in the condition with non-matching datatypes, convert the datatypes so they match.

If you join Char and Varchar datatypes, the Integration Service counts any spaces that pad Char values as part of the string:

```
Char(40) = "abcd"  
Varchar(40) = "abcd"
```

The Char value is "abcd" padded with 36 blank spaces, and the Integration Service does not join the two fields because the Char field contains trailing spaces.

Note: The Joiner transformation does not match null values. For example, if both EMP_ID1 and EMP_ID2 contain a row with a null value, the Integration Service does not consider them a match and does not join the two rows. To join rows with null values, replace null input with default values, and then join on the default values.

Defining the Join Type

In SQL, a join is a relational operator that combines data from multiple tables into a single result set. The Joiner transformation is similar to an SQL join except that data can originate from different types of sources.

You define the join type on the Properties tab in the transformation. The Joiner transformation supports the following types of joins:

- Normal
- Master Outer
- Detail Outer
- Full Outer

Note: A normal or master outer join performs faster than a full outer or detail outer join.

If a result set includes fields that do not contain data in either of the sources, the Joiner transformation populates the empty fields with null values. If you know that a field will return a NULL and you do not want to insert NULLs in the target, you can set a default value on the Ports tab for the corresponding port.

Normal Join

With a normal join, the Integration Service discards all rows of data from the master and detail source that do not match, based on the condition.

For example, you might have two sources of data for auto parts called PARTS_SIZE and PARTS_COLOR with the following data:

PARTS_SIZE (master source)

PART_ID1	DESCRIPTION	SIZE
1	Seat Cover	Large
2	Ash Tray	Small
3	Floor Mat	Medium

PARTS_COLOR (detail source)

PART_ID2	DESCRIPTION	COLOR
1	Seat Cover	Blue
3	Floor Mat	Black
4	Fuzzy Dice	Yellow

To join the two tables by matching the PART_IDs in both sources, you set the condition as follows:

```
PART_ID1 = PART_ID2
```

When you join these tables with a normal join, the result set includes the following data:

PART_ID	DESCRIPTION	SIZE	COLOR
1	Seat Cover	Large	Blue
3	Floor Mat	Medium	Black

The following example shows the equivalent SQL statement:

```
SELECT * FROM PARTS_SIZE, PARTS_COLOR WHERE PARTS_SIZE.PART_ID1 = PARTS_COLOR.PART_ID2
```

Master Outer Join

A master outer join keeps all rows of data from the detail source and the matching rows from the master source. It discards the unmatched rows from the master source.

When you join the sample tables with a master outer join and the same condition, the result set includes the following data:

PART_ID	DESCRIPTION	SIZE	COLOR
1	Seat Cover	Large	Blue
3	Floor Mat	Medium	Black
4	Fuzzy Dice	NULL	Yellow

Because no size is specified for the Fuzzy Dice, the Integration Service populates the field with a NULL.

The following example shows the equivalent SQL statement:

```
SELECT * FROM PARTS_SIZE RIGHT OUTER JOIN PARTS_COLOR ON (PARTS_COLOR.PART_ID2 = PARTS_SIZE.PART_ID1)
```

Detail Outer Join

A detail outer join keeps all rows of data from the master source and the matching rows from the detail source. It discards the unmatched rows from the detail source.

When you join the sample tables with a detail outer join and the same condition, the result set includes the following data:

PART_ID	DESCRIPTION	SIZE	COLOR
1	Seat Cover	Large	Blue
2	Ash Tray	Small	NULL
3	Floor Mat	Medium	Black

Because no color is specified for the Ash Tray, the Integration Service populates the field with a NULL.

The following example shows the equivalent SQL statement:

```
SELECT * FROM PARTS_SIZE LEFT OUTER JOIN PARTS_COLOR ON (PARTS_SIZE.PART_ID1 = PARTS_COLOR.PART_ID2)
```

Full Outer Join

A full outer join keeps all rows of data from both the master and detail sources.

When you join the sample tables with a full outer join and the same condition, the result set includes:

PART_ID	DESCRIPTION	SIZE	Color
1	Seat Cover	Large	Blue
2	Ash Tray	Small	NULL
3	Floor Mat	Medium	Black
4	Fuzzy Dice	NULL	Yellow

Because no color is specified for the Ash Tray and no size is specified for the Fuzzy Dice, the Integration Service populates the fields with NULL.

The following example shows the equivalent SQL statement:

```
SELECT * FROM PARTS_SIZE FULL OUTER JOIN PARTS_COLOR ON (PARTS_SIZE.PART_ID1 = PARTS_COLOR.PART_ID2)
```

Using Sorted Input

You can improve session performance by configuring the Joiner transformation to use sorted input. When you configure the Joiner transformation to use sorted data, the Integration Service improves performance by

minimizing disk input and output. You see the greatest performance improvement when you work with large data sets.

To configure a mapping to use sorted data, you establish and maintain a sort order in the mapping so the Integration Service can use the sorted data when it processes the Joiner transformation. Complete the following tasks to configure the mapping:

- **Configure the sort order.** Configure the sort order of the data you want to join. You can join sorted flat files, or you can sort relational data using a Source Qualifier transformation. You can also use a Sorter transformation.
- **Add transformations.** Use transformations that maintain the order of the sorted data.
- **Configure the Joiner transformation.** Configure the Joiner transformation to use sorted data and configure the join condition to use the sort origin ports. The sort origin represents the source of the sorted data.

When you configure the sort order in a session, you can select a sort order associated with the Integration Service code page. When you run the Integration Service in Unicode mode, it uses the selected session sort order to sort character data. When you run the Integration Service in ASCII mode, it sorts all character data using a binary sort order. To ensure that data is sorted as the Integration Service requires, the database sort order must be the same as the user-defined session sort order.

When you join sorted data from partitioned pipelines, you must configure the partitions to maintain the order of sorted data.

Configuring the Sort Order

You must configure the sort order to ensure that the Integration Service passes sorted data to the Joiner transformation.

Configure the sort order using one of the following methods:

- **Use sorted flat files.** When the flat files contain sorted data, verify that the order of the sort columns match in each source file.
- **Use sorted relational data.** Use sorted ports in the Source Qualifier transformation to sort columns from the source database. Configure the order of the sorted ports the same in each Source Qualifier transformation.
- **Use Sorter transformations.** Use a Sorter transformation to sort relational or flat file data. Place a Sorter transformation in the master and detail pipelines. Configure each Sorter transformation to use the same order of the sort key ports and the sort order direction.

If you pass unsorted or incorrectly sorted data to a Joiner transformation configured to use sorted data, the session fails and the Integration Service logs the error in the session log file.

Adding Transformations to the Mapping

When you add transformations between the sort origin and the Joiner transformation, use the following guidelines to maintain sorted data:

- Do not place any of the following transformations between the sort origin and the Joiner transformation:
 - Custom
 - Unsorted Aggregator
 - Normalizer
 - Rank

- Union transformation
 - XML Parser transformation
 - XML Generator transformation
 - Mapplet, if it contains one of the above transformations
 - You can place a sorted Aggregator transformation between the sort origin and the Joiner transformation if you use the following guidelines:
 - Configure the Aggregator transformation for sorted input.
 - Use the same ports for the group by columns in the Aggregator transformation as the ports at the sort origin.
 - The group by ports must be in the same order as the ports at the sort origin.
 - When you join the result set of a Joiner transformation with another pipeline, verify that the data output from the first Joiner transformation is sorted.
- Tip:** You can place the Joiner transformation directly after the sort origin to maintain sorted data.

Configuring the Joiner Transformation

To configure the Joiner transformation, complete the following tasks:

- Enable Sorted Input on the Properties tab.
- Define the join condition to receive sorted data in the same order as the sort origin.

Defining the Join Condition

Configure the join condition to maintain the sort order established at the sort origin: the sorted flat file, the Source Qualifier transformation, or the Sorter transformation. If you use a sorted Aggregator transformation between the sort origin and the Joiner transformation, treat the sorted Aggregator transformation as the sort origin when you define the join condition. Use the following guidelines when you define join conditions:

- The ports you use in the join condition must match the ports at the sort origin.
- When you configure multiple join conditions, the ports in the first join condition must match the first ports at the sort origin.
- When you configure multiple conditions, the order of the conditions must match the order of the ports at the sort origin, and you must not skip any ports.
- The number of sorted ports in the sort origin can be greater than or equal to the number of ports at the join condition.

Example of a Join Condition

For example, you configure Sorter transformations in the master and detail pipelines with the following sorted ports:

1. ITEM_NO
2. ITEM_NAME
3. PRICE

When you configure the join condition, use the following guidelines to maintain sort order:

- You must use ITEM_NO in the first join condition.
- If you add a second join condition, you must use ITEM_NAME.

- If you want to use PRICE in a join condition, you must also use ITEM_NAME in the second join condition.

If you skip ITEM_NAME and join on ITEM_NO and PRICE, you lose the sort order and the Integration Service fails the session.

When you use the Joiner transformation to join the master and detail pipelines, you can configure any one of the following join conditions:

```
ITEM_NO = ITEM_NO
```

or

```
ITEM_NO = ITEM_NO1  
ITEM_NAME = ITEM_NAME1
```

or

```
ITEM_NO = ITEM_NO1  
ITEM_NAME = ITEM_NAME1  
PRICE = PRICE1
```

Joining Data from a Single Source

You may want to join data from the same source if you want to perform a calculation on part of the data and join the transformed data with the original data. When you join the data using this method, you can maintain the original data and transform parts of that data within one mapping. You can join data from the same source in the following ways:

- Join two branches of the same pipeline.
- Join two instances of the same source.

Joining Two Branches of the Same Pipeline

When you join data from the same source, you can create two branches of the pipeline. When you branch a pipeline, you must add a transformation between the source qualifier and the Joiner transformation in at least one branch of the pipeline. You must join sorted data and configure the Joiner transformation for sorted input.

For example, you have a source with the following ports:

- Employee
- Department
- Total Sales

In the target, you want to view the employees who generated sales that were greater than the average sales for their departments. To do this, you create a mapping with the following transformations:

- **Sorter transformation.** Sorts the data.
- **Sorted Aggregator transformation.** Averages the sales data and group by department. When you perform this aggregation, you lose the data for individual employees. To maintain employee data, you must pass a branch of the pipeline to the Aggregator transformation and pass a branch with the same data to the Joiner transformation to maintain the original data. When you join both branches of the pipeline, you join the aggregated data with the original data.
- **Sorted Joiner transformation.** Uses a sorted Joiner transformation to join the sorted aggregated data with the original data.

- **Filter transformation.** Compares the average sales data against sales data for each employee and filter out employees with less than above average sales.

The following figure shows a mapping that joins two branches of the same pipeline:

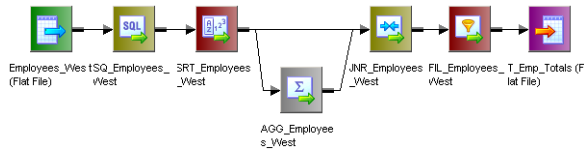

Note: You can also join data from output groups of the same transformation, such as the Custom transformation or XML Source Qualifier transformation. Place a Sorter transformation between each output group and the Joiner transformation and configure the Joiner transformation to receive sorted input.

Joining two branches might impact performance if the Joiner transformation receives data from one branch much later than the other branch. The Joiner transformation caches all the data from the first branch, and writes the cache to disk if the cache fills. The Joiner transformation must then read the data from disk when it receives the data from the second branch. This can slow processing.

Joining Two Instances of the Same Source

You can also join same source data by creating a second instance of the source. After you create the second source instance, you can join the pipelines from the two source instances. If you want to join unsorted data, you must create two instances of the same source and join the pipelines.

The following figure shows two instances of the same source joined with a Joiner transformation:

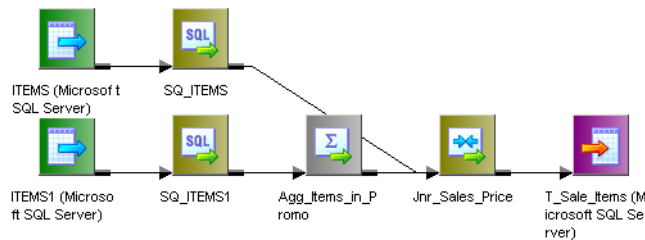

Note: When you join data using this method, the Integration Service reads the source data for each source instance, so performance can be slower than joining two branches of a pipeline.

Guidelines for Joining Data from a Single Source

Use the following guidelines when deciding whether to join branches of a pipeline or join two instances of a source:

- Join two branches of a pipeline when you have a large source or if you can read the source data only once. For example, you can only read source data from a message queue once.
- Join two branches of a pipeline when you use sorted data. If the source data is unsorted and you use a Sorter transformation to sort the data, branch the pipeline after you sort the data.
- Join two instances of a source when you need to add a blocking transformation to the pipeline between the source and the Joiner transformation.
- Join two instances of a source if one pipeline may process slower than the other pipeline.
- Join two instances of a source if you need to join unsorted data.

Blocking the Source Pipelines

When you run a session with a Joiner transformation, the Integration Service blocks and unblocks the source data, based on the mapping configuration and whether you configure the Joiner transformation for sorted input.

Unsorted Joiner Transformation

When the Integration Service processes an unsorted Joiner transformation, it reads all master rows before it reads the detail rows. To ensure it reads all master rows before the detail rows, the Integration Service blocks the detail source while it caches rows from the master source. Once the Integration Service reads and caches all master rows, it unblocks the detail source and reads the detail rows. Some mappings with unsorted Joiner transformations violate data flow validation.

Sorted Joiner Transformation

When the Integration Service processes a sorted Joiner transformation, it blocks data based on the mapping configuration. Blocking logic is possible if master and detail input to the Joiner transformation originate from different sources.

The Integration Service uses blocking logic to process the Joiner transformation if it can do so without blocking all sources in a target load order group simultaneously. Otherwise, it does not use blocking logic. Instead, it stores more rows in the cache.

When the Integration Service can use blocking logic to process the Joiner transformation, it stores fewer rows in the cache, increasing performance.

Caching Master Rows

When the Integration Service processes a Joiner transformation, it reads rows from both sources concurrently and builds the index and data cache based on the master rows. The Integration Service then performs the join based on the detail source data and the cache data. The number of rows the Integration Service stores in the cache depends on the partition type, the source data, and whether you configure the Joiner transformation for sorted input. To improve performance for an unsorted Joiner transformation, use the source with fewer rows as the master source. To improve performance for a sorted Joiner transformation, use the source with fewer duplicate key values as the master.

Working with Transactions

When the Integration Service processes a Joiner transformation, it can apply transformation logic to all data in a transaction, all incoming data, or one row of data at a time. The Integration Service can drop or preserve transaction boundaries depending on the mapping configuration and the transformation scope. You configure how the Integration Service applies transformation logic and handles transaction boundaries using the transformation scope property.

You configure transformation scope values based on the mapping configuration and whether you want to preserve or drop transaction boundaries.

You can preserve transaction boundaries when you join the following sources:

- **You join two branches of the same source pipeline.** Use the Transaction transformation scope to preserve transaction boundaries.
- **You join two sources, and you want to preserve transaction boundaries for the detail source.** Use the Row transformation scope to preserve transaction boundaries in the detail pipeline.

You can drop transaction boundaries when you join the following sources:

- **You join two sources or two branches and you want to drop transaction boundaries.** Use the All Input transformation scope to apply the transformation logic to all incoming data and drop transaction boundaries for both pipelines.

The following table summarizes how to preserve transaction boundaries using transformation scopes with the Joiner transformation:

Transformation Scope	Input Type	Integration Service Behavior
Row	Unsorted	Preserves transaction boundaries in the detail pipeline.
Row	Sorted	Session fails.
Transaction	Sorted	Preserves transaction boundaries when master and detail originate from the same transaction generator. Session fails when master and detail do not originate from the same transaction generator
Transaction	Unsorted	Session fails.
All Input	Sorted, Unsorted	Drops transaction boundaries.

Note: Sessions fail if you use real-time data with All Input or Transaction transformation scopes.

Preserving Transaction Boundaries for a Single Pipeline

When you join data from the same source, use the Transaction transformation scope to preserve incoming transaction boundaries for a single pipeline. Use the Transaction transformation scope when the Joiner transformation joins data from the same source, either two branches of the same pipeline or two output groups of one transaction generator. Use this transformation scope with sorted data and any join type.

When you use the Transaction transformation scope, verify that master and detail pipelines originate from the same transaction control point and that you use sorted input. For example, in [“Preserving Transaction Boundaries for a Single Pipeline” on page 276](#) the Sorter transformation is the transaction control point. You cannot place another transaction control point between the Sorter transformation and the Joiner transformation. In the mapping, the master and detail pipeline branches originate from the same transaction control point, and the Integration Service joins the pipeline branches with the Joiner transformation, preserving transaction boundaries.

The following figure shows a mapping that joins two branches of a pipeline and preserves transaction boundaries:

Figure 1. Preserving Transaction Boundaries when You Join Two Pipeline Branches

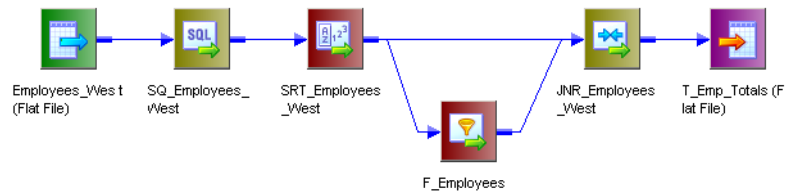

Preserving Transaction Boundaries in the Detail Pipeline

When you want to preserve the transaction boundaries in the detail pipeline, choose the Row transformation scope. The Row transformation scope allows the Integration Service to process data one row at a time. The Integration Service caches the master data and matches the detail data with the cached master data.

When the source data originates from a real-time source, such as IBM MQ Series, the Integration Service matches the cached master data with each message as it is read from the detail source.

Use the Row transformation scope with Normal and Master Outer join types that use unsorted data.

Dropping Transaction Boundaries for Two Pipelines

When you want to join data from two sources or two branches and you do not need to preserve transaction boundaries, use the All Input transformation scope. When you use All Input, the Integration Service drops incoming transaction boundaries for both pipelines and outputs all rows from the transformation as an open transaction. At the Joiner transformation, the data from the master pipeline can be cached or joined concurrently, depending on how you configure the sort order. Use this transformation scope with sorted and unsorted data and any join type.

Creating a Joiner Transformation

To use a Joiner transformation, add a Joiner transformation to the mapping, set up the input sources, and configure the transformation with a condition and join type and sort type.

To create a Joiner transformation:

1. In the Mapping Designer, click Transformation > Create. Select the Joiner transformation. Enter a name, and click OK.

The naming convention for Joiner transformations is *JNR_TransformationName*. Enter a description for the transformation.

The Designer creates the Joiner transformation.

2. Drag all the input/output ports from the first source into the Joiner transformation.

The Designer creates input/output ports for the source fields in the Joiner transformation as detail fields by default. You can edit this property later.

3. Select and drag all the input/output ports from the second source into the Joiner transformation.
The Designer configures the second set of source fields and master fields by default.
4. Double-click the title bar of the Joiner transformation to open the transformation.
5. Click the Ports tab.
6. Click any box in the M column to switch the master/detail relationship for the sources.
Tip: To improve performance for an unsorted Joiner transformation, use the source with fewer rows as the master source. To improve performance for a sorted Joiner transformation, use the source with fewer duplicate key values as the master.
7. Add default values for specific ports.
Some ports are likely to contain null values, since the fields in one of the sources may be empty. You can specify a default value if the target database does not handle NULLs.
8. Click the Condition tab and set the join condition.
9. Click the Add button to add a condition. You can add multiple conditions.
The master and detail ports must have matching datatypes. The Joiner transformation only supports equivalent (=) joins.
10. Click the Properties tab and configure properties for the transformation.
Note: You can edit the join condition from the Condition tab. The keyword AND separates multiple conditions.
11. Click OK.
12. Click the Metadata Extensions tab to configure metadata extensions.

Tips for Joiner Transformations

Perform joins in a database when possible.

Performing a join in a database is faster than performing a join in the session. In some cases, this is not possible, such as joining tables from two different databases or flat file systems. If you want to perform a join in a database, use the following options:

- Create a pre-session stored procedure to join the tables in a database.
- Use the Source Qualifier transformation to perform the join.

Join sorted data when possible.

You can improve session performance by configuring the Joiner transformation to use sorted input. When you configure the Joiner transformation to use sorted data, the Integration Service improves performance by minimizing disk input and output. You see the greatest performance improvement when you work with large data sets.

For an unsorted Joiner transformation, designate the source with fewer rows as the master source.

For optimal performance and disk storage, designate the source with the fewer rows as the master source. During a session, the Joiner transformation compares each row of the master source against the detail

source. The fewer unique rows in the master, the fewer iterations of the join comparison occur, which speeds the join process.

For a sorted Joiner transformation, designate the source with fewer duplicate key values as the master source.

For optimal performance and disk storage, designate the source with fewer duplicate key values as the master source. When the Integration Service processes a sorted Joiner transformation, it caches rows for one hundred keys at a time. If the master source contains many rows with the same key value, the Integration Service must cache more rows, and performance can be slowed.

CHAPTER 17

Lookup Transformation

This chapter includes the following topics:

- [Lookup Transformation Overview, 280](#)
- [Lookup Source Types, 281](#)
- [Connected and Unconnected Lookups, 284](#)
- [Lookup Components, 286](#)
- [Lookup Properties, 288](#)
- [Lookup Query, 294](#)
- [Lookup Condition, 297](#)
- [Lookup Caches, 299](#)
- [Return Multiple Rows, 300](#)
- [Configuring Unconnected Lookup Transformations, 301](#)
- [Database Deadlock Resilience, 303](#)
- [Creating a Lookup Transformation, 303](#)
- [Tips for Lookup Transformations, 305](#)

Lookup Transformation Overview

Use a Lookup transformation in a mapping to look up data in a flat file, relational table, view, or synonym. You can import a lookup definition from any flat file or relational database to which both the PowerCenter Client and Integration Service can connect. You can also create a lookup definition from a source qualifier. You can use multiple Lookup transformations in a mapping. The Lookup transformation can be an active or passive transformation. You can configure a connected or unconnected Lookup transformation.

The Integration Service queries the lookup source based on the lookup ports in the transformation and a lookup condition. The Lookup transformation returns the result of the lookup to the target or another transformation. You can configure the Lookup transformation to return a single row or multiple rows.

Perform the following tasks with a Lookup transformation:

- **Get a related value.** Retrieve a value from the lookup table based on a value in the source. For example, the source has an employee ID. Retrieve the employee name from the lookup table.
- **Get multiple values.** Retrieve multiple rows from a lookup table. For example, return all employees in a department.

- **Perform a calculation.** Retrieve a value from a lookup table and use it in a calculation. For example, retrieve a sales tax percentage, calculate a tax, and return the tax to a target.
- **Update slowly changing dimension tables.** Determine whether rows exist in a target.

Configure the Lookup transformation to perform the following types of lookups:

- **Relational or flat file lookup.** Perform a lookup on a flat file or a relational table. When you create a Lookup transformation using a relational table as the lookup source, you can connect to the lookup source using ODBC and import the table definition as the structure for the Lookup transformation. When you create a Lookup transformation using a flat file as a lookup source, the Designer invokes the Flat File Wizard.
- **Pipeline lookup.** Perform a lookup on application sources such as JMS or MSMQ. Drag the source into the mapping and associate the Lookup transformation with the source qualifier. Configure partitions to improve performance when the Integration Service retrieves source data for the lookup cache.
- **Connected or unconnected lookup.** A connected Lookup transformation receives source data, performs a lookup, and returns data to the pipeline. An unconnected Lookup transformation is not connected to a source or target. A transformation in the pipeline calls the Lookup transformation with a :LKP expression. The unconnected Lookup transformation returns one column to the calling transformation.
- **Cached or uncached lookup.** Cache the lookup source to improve performance. If you cache the lookup source, you can use a dynamic or static cache. By default, the lookup cache remains static and does not change during the session. With a dynamic cache, the Integration Service inserts or updates rows in the cache. When you cache the target table as the lookup source, you can look up values in the cache to determine if the values exist in the target. The Lookup transformation marks rows to insert or update the target.

Lookup Source Types

When you create a Lookup transformation, you can choose a relational table, flat file, or a source qualifier as the lookup source.

Relational Lookups

When you create a Lookup transformation using a relational table as a lookup source, you can connect to the lookup source using ODBC and import the table definition as the structure for the Lookup transformation.

Use the following options with relational lookups:

- Override the default SQL statement to add a WHERE clause or to query multiple tables.
- Sort null data high or low, based on database support.
- Perform case-sensitive comparisons based on the database support.

Flat File Lookups

When you create a Lookup transformation using a flat file as a lookup source, select a flat file definition in the repository or import the source when you create the transformation. When you import a flat file lookup source, the Designer invokes the Flat File Wizard.

Use the following options with flat file lookups:

- Use indirect files as lookup sources by configuring a file list as the lookup file name.

- Use sorted input for the lookup.
- Sort null data high or low.
- Use case-sensitive string comparison with flat file lookups.

Using Sorted Input

When you configure a flat file Lookup transformation for sorted input, the condition columns must be grouped. If the condition columns are not grouped, the Lookup transformation returns incorrect results. For optimal caching performance, sort the condition columns.

For example, a Lookup transformation has the following condition:

```
OrderID = OrderID1
CustID = CustID1
```

In the following flat file lookup source, the keys are grouped, but not sorted. The Integration Service can cache the data, but performance may not be optimal.

OrderID	CustID	ItemNo.	ItemDesc	Comments
1001	CA502	F895S	Flashlight	Key data is grouped, but not sorted. CustID is out of order within OrderID.
1001	CA501	C530S	Compass	-
1001	CA501	T552T	Tent	-
1005	OK503	S104E	Safety Knife	Key data is grouped, but not sorted. OrderID is out of order.
1003	CA500	F304T	First Aid Kit	-
1003	TN601	R938M	Regulator System	-

The keys are not grouped in the following flat file lookup source. The Lookup transformation returns incorrect results.

OrderID	CustID	ItemNo.	ItemDesc	Comments
1001	CA501	T552T	Tent	-
1001	CA501	C530S	Compass	-
1005	OK503	S104E	Safety Knife	-
1003	TN601	R938M	Regulator System	-
1003	CA500	F304T	First Aid Kit	-
1001	CA502	F895S	Flashlight	Key data for CustID is not grouped.

If you choose sorted input for indirect files, the range of data must not overlap in the files.

Pipeline Lookups

Create a pipeline Lookup transformation to perform a lookup on an application source that is not a relational table or flat file. A pipeline Lookup transformation has a source qualifier as the lookup source. You can perform pipeline lookups on all data sources except on Application Multi-Group Source Qualifier transformations.

When you configure a pipeline Lookup transformation, the lookup source and source qualifier are in a different pipeline from the Lookup transformation. The source and source qualifier are in a partial pipeline that contains no target. The Integration Service reads the source data in this pipeline and passes the data to the Lookup transformation to create the cache. You can create multiple partitions in the partial pipeline to improve performance.

To improve performance when processing relational or flat file lookup sources, create a pipeline Lookup transformation instead of a relational or flat file Lookup transformation. You can create partitions to process the lookup source and pass it to the Lookup transformation.

Create a connected or unconnected pipeline Lookup transformation.

Note: Do not enable HA recovery for sessions that have real-time sources for pipeline lookups. You might get unexpected results.

Configuring a Pipeline Lookup Transformation in a Mapping

A mapping that contains a pipeline Lookup transformation includes a partial pipeline that contains the lookup source and source qualifier. The partial pipeline does not include a target. The Integration Service retrieves the lookup source data in this pipeline and passes the data to the lookup cache.

The partial pipeline is in a separate target load order group in session properties. You can create multiple partitions in the pipeline to improve performance. You can not configure the target load order with the partial pipeline.

The following mapping shows a mapping that contains a pipeline Lookup transformation and the partial pipeline that processes the lookup source:

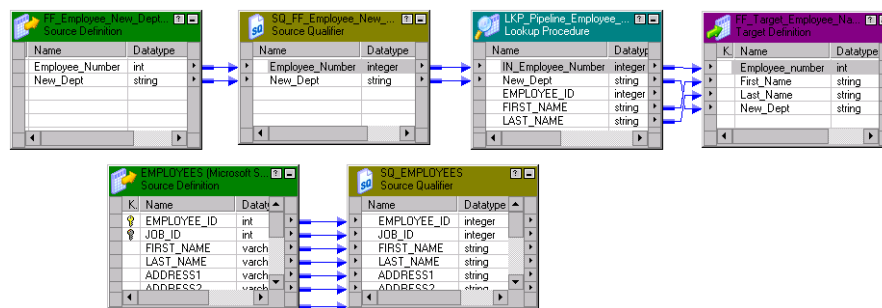

The mapping contains the following objects:

- The lookup source definition and source qualifier are in a separate pipeline. The Integration Service creates a lookup cache after it processes the lookup source data in the pipeline.
- A flat file source contains new department names by employee number.
- The pipeline Lookup transformation receives Employee_Number and New_Dept from the source file. The pipeline Lookup performs a lookup on Employee_ID in the lookup cache. It retrieves the employee first and last name from the lookup cache.

- A flat file target receives the Employee_ID, First_Name, Last_Name, and New_Dept from the Lookup transformation.

Connected and Unconnected Lookups

You can configure a connected Lookup transformation or an unconnected Lookup transformation. A connected Lookup transformation is a transformation that has input and output ports that you connect to other transformations in a mapping. An unconnected Lookup transformation appears in the mapping, but is not connected to other transformations.

An unconnected Lookup transformation receives input from the result of a :LKP expression in a transformation such as an Expression transformation or Aggregator transformation. The :LKP expression passes arguments to the Lookup transformation and receives a result back from the Lookup transformation. The :LKP expression can pass lookup results to another expression in the Expression or Aggregator transformation to filter results.

The following table lists the differences between connected and unconnected lookups:

Connected Lookup	Unconnected Lookup
Receives input values directly from the pipeline.	Receives input values from the result of a :LKP expression in another transformation.
Use a dynamic or static cache.	Use a static cache.
Cache includes the lookup source columns in the lookup condition and the lookup source columns that are output ports.	Cache includes all lookup and output ports in the lookup condition and the lookup/return port.
Returns multiple columns from the same row or insert into the dynamic lookup cache.	Returns one column from each row to a return port.
If there is no match for the lookup condition, the Integration Service returns the default value for all output ports. If you configure dynamic caching, the Integration Service inserts rows into the cache or leaves it unchanged.	If there is no match for the lookup condition, the Integration Service returns NULL.
If there is a match for the lookup condition, the Integration Service returns the result of the lookup condition for all lookup/output ports. If you configure dynamic caching, the Integration Service either updates the row the in the cache or leaves the row unchanged.	If a match occurs for the lookup condition, the Integration Service returns the result of the lookup condition to the return port.
Passes multiple output values to another transformation. Link lookup/output ports to another transformation.	Returns one output value to another transformation. The Lookup transformation return port passes the value to the port that contains the :LKP expression in the other transformation.
Supports user-defined default values.	Does not support user-defined default values.

Connected Lookups

A connected Lookup transformation is a Lookup transformation that is connected to a source or target in a mapping.

When you run a mapping that contains a connected Lookup transformation, the Integration Service performs the following steps:

1. The Integration Service passes values from another transformation to input ports in the Lookup transformation.
2. For each input row, the Integration Service queries the lookup source or cache based on the lookup ports and the lookup condition in the transformation.
3. If the transformation is uncached or uses a static cache, the Integration Service returns values from the lookup query.

If the transformation uses a dynamic cache, the Integration Service inserts the row into the cache when it does not find the row in the cache. When the Integration Service finds the row in the cache, it updates the row in the cache or leaves it unchanged. It flags the row as insert, update, or no change.

4. The Integration Service returns data from the query and passes it to the next transformation in the mapping.

If the transformation uses a dynamic cache, you can pass rows to a Filter or Router transformation to filter new rows to the target.

Note: This chapter discusses connected Lookup transformations unless otherwise specified.

Unconnected Lookups

An unconnected Lookup transformation is a Lookup transformation that is not connected to a source or target in the mapping. Call the lookup with a :LKP expression in a transformation that allows expressions.

A common use for unconnected Lookup transformations is to update slowly changing dimension tables. For more information about slowly changing dimension tables, visit the Informatica Knowledge Base at <http://mysupport.informatica.com>.

The syntax for the lookup expression is `:LKP lookup_transformation_name(argument, argument, ...)`

The order in which you list each argument must match the order of the lookup conditions in the Lookup transformation. The Lookup transformation returns the result of the query through the Lookup transformation return port. The transformation that calls the lookup receives the lookup result value in the port that contains the :LKP expression. If the lookup query fails to return a value, the port receives a null value.

When you perform an unconnected lookup, you can perform the same lookup multiple times in a mapping. You can test the results of the lookup in another expression and filter rows based on the results.

When you run a mapping that contains an unconnected Lookup transformation, the Integration Service performs the following steps:

1. An unconnected Lookup transformation receives input values from the result of a :LKP expression in another transformation, such as an Aggregator transformation, Expression transformation, or Update Strategy transformation.
2. The Integration Service queries the lookup source or cache based on the lookup ports and condition in the Lookup transformation.
3. The Integration Service returns a value through the return port of the Lookup transformation.
4. The Integration Service passes the return value to the port that contains the :LKP expression.

Lookup Components

Define the following components when you configure a Lookup transformation in a mapping:

- Lookup source
- Ports
- Properties
- Condition

Lookup Source

Use a flat file, relational table, or source qualifier for a lookup source. When you create a Lookup transformation, you can create the lookup source from the following locations:

- Relational source or target definition in the repository
- Flat file source or target definition in the repository
- Table or file that the Integration Service and PowerCenter Client machine can connect to
- Source qualifier definition in a mapping

The lookup table can be a single table, or you can join multiple tables in the same database using a lookup SQL override. The Integration Service queries the lookup table or an in-memory cache of the table for all incoming rows into the Lookup transformation.

The Integration Service can connect to a lookup table using ODBC or native drivers. Configure native drivers for optimal performance.

Indexes and a Lookup Table

If you have privileges to modify the database containing a lookup table, you can improve lookup initialization time by adding an index to the lookup table. You can improve performance for very large lookup tables. Since the Integration Service queries, sorts, and compares values in lookup columns, the index needs to include every column in a lookup condition.

You can improve performance by indexing the following types of lookup:

- **Cached lookups.** You can improve performance by indexing the columns in the lookup ORDER BY. The session log contains the ORDER BY clause.
- **Uncached lookups.** Because the Integration Service issues a SELECT statement for each row passing into the Lookup transformation, you can improve performance by indexing the columns in the lookup condition.

Lookup Ports

The Ports tab contains input and output ports. The Ports tab also includes lookup ports that represent columns of data to return from the lookup source. An unconnected Lookup transformation returns one column of data to the calling transformation in this port. An unconnected Lookup transformation has one return port.

The following table describes the port types in a Lookup transformation:

Ports	Type of Lookup	Description
I	Connected Unconnected	Input port. Create an input port for each lookup port you want to use in the lookup condition. You must have at least one input or input/output port in each Lookup transformation.
O	Connected Unconnected	Output port. Create an output port for each lookup port you want to link to another transformation. You can designate both input and lookup ports as output ports. For connected lookups, you must have at least one output port. For unconnected lookups, select a lookup port as a return port (R) to pass a return value.
L	Connected Unconnected	Lookup port. The Designer designates each column in the lookup source as a lookup (L) and output port (O).
R	Unconnected	Return port. Use only in unconnected Lookup transformations. Designates the column of data you want to return based on the lookup condition. You can designate one lookup port as the return port.

The Lookup transformation also enables an associated expression property that you configure when you use a dynamic cache. The associated expression property contains the data to update the lookup cache. It can contain an expression to update the dynamic cache or it can contain an input port name.

Use the following guidelines to configure lookup ports:

- If you delete lookup ports from a flat file lookup, the session fails.
- You can delete lookup ports from a relational lookup if the mapping does not use the lookup port. This reduces the amount of memory the Integration Service needs to run the session.

Lookup Properties

On the Properties tab, configure properties such as an SQL override for relational lookups, the lookup source name caching properties.

RELATED TOPICS:

- [“Lookup Properties” on page 288](#)

Lookup Condition

On the Condition tab, enter the condition or conditions you want the Integration Service to use to find data in the lookup source.

RELATED TOPICS:

- [“Lookup Condition” on page 297](#)

Lookup Properties

Configure the lookup properties such as caching and multiple matches on the Lookup Properties tab. Configure the lookup condition or the SQL statements to query the lookup table. You can also change the Lookup table name.

When you create a mapping, you configure the properties for each Lookup transformation. When you create a session, you can override properties such as the index and the data cache size for each transformation.

The following table describes the Lookup transformation properties:

Option	Lookup Type	Description
Lookup SQL Override	Relational	Overrides the default SQL statement to query the lookup table. Specifies the SQL statement you want the Integration Service to use for querying lookup values. Use with the lookup cache enabled.
Lookup Table Name	Pipeline Relational	The name of the table or the source qualifier from which the transformation looks up and caches values. When you create the Lookup transformation, choose a source, target, or source qualifier as the lookup source. You can also import a table, view, or synonym from another database when you create the Lookup transformation. If you enter a lookup SQL override, you do not need to enter the Lookup Table Name.
Lookup Source Filter	Relational	Restricts the lookups the Integration Service performs based on the value of data in any port in the Lookup transformation. Use with the lookup cache enabled.
Lookup Caching Enabled	Flat File Pipeline Relational	Indicates whether the Integration Service caches lookup values during the session. When you enable lookup caching, the Integration Service queries the lookup source once, caches the values, and looks up values in the cache during the session. Caching the lookup values can improve session performance. When you disable caching, each time a row passes into the transformation, the Integration Service issues a select statement to the lookup source for lookup values. Note: The Integration Service always caches the flat file lookups and the pipeline lookups.

Option	Lookup Type	Description
Lookup Policy on Multiple Match	Flat File Pipeline Relational	<p>Determines which rows to return when the Lookup transformation finds multiple rows that match the lookup condition. Select one of the following values:</p> <ul style="list-style-type: none"> - Use First Value. Returns the first row that matches the lookup condition. - Use Last Value. Return the last row that matches the lookup condition. - Use All Values. Return all matching rows. - Use Any Value. The Integration Service returns the first value that matches the lookup condition. It creates an index based on the key ports instead of all Lookup transformation ports. - Report Error. The Integration Service reports an error and does not return a row. If you do not enable the Output Old Value On Update option, the Lookup Policy On Multiple Match option is set to Report Error for dynamic lookups.
Lookup Condition	Flat File Pipeline Relational	Displays the lookup condition you set in the Condition tab.
Connection Information	Relational	<p>Specifies the database that contains the lookup table. You can define the database in the mapping, session, or parameter file:</p> <ul style="list-style-type: none"> - Mapping. Select the connection object. You can also specify the database connection type. Type <code>Relational</code>: before the connection name if it is a relational connection. Type <code>Application</code>: before the connection name if it is an application connection. - Session. Use the <code>\$Source</code> or <code>\$Target</code> connection variable. If you use one of these variables, the lookup table must reside in the source or the target database. Specify the database connection in the session properties for each variable. - Parameter file. Use the session parameter <code>\$DBConnectionName</code> or <code>\$AppConnectionName</code>, and define it in the parameter file. <p>By default, the Designer specifies <code>\$Source</code> if you choose a source table and <code>\$Target</code> if you choose a target table when you create the Lookup transformation. You can override these values in the session properties.</p> <p>The Integration Service fails the session if it cannot determine the type of database connection.</p>
Source Type	Flat File Pipeline Relational	Indicates that the Lookup transformation reads values from a relational table, flat file, or source qualifier.
Tracing Level	Flat File Pipeline Relational	Sets the amount of detail included in the session log.
Lookup Cache Directory Name	Flat File Pipeline Relational	<p>Specifies the directory used to build the lookup cache files when you configure the Lookup transformation to cache the lookup source. Also saves the persistent lookup cache files when you select the Lookup Persistent option.</p> <p>By default, the Integration Service uses the <code>\$PMCacheDir</code> directory configured for the Integration Service.</p>

Option	Lookup Type	Description
Lookup Cache Persistent	Flat File Pipeline Relational	Indicates whether the Integration Service uses a persistent lookup cache, which consists of at least two cache files. If a Lookup transformation is configured for a persistent lookup cache and persistent lookup cache files do not exist, the Integration Service creates the files during the session. Use with the lookup cache enabled.
Lookup Data Cache Size Lookup Index Cache Size	Flat File Pipeline Relational	Default is Auto. Indicates the maximum size the Integration Service allocates to the data cache and the index in memory. You can use a numeric value for the cache, you can use a cache value from a parameter file or you can configure the Integration Service to set the cache size by using the Auto setting. If you configure the Integration Service to determine the cache size, you can also configure a maximum amount of memory for the Integration Service to allocate to the cache. If the Integration Service cannot allocate the configured amount of memory when initializing the session, it fails the session. When the Integration Service cannot store all the data cache data in memory, it pages to disk. Use with the lookup cache enabled.
Dynamic Lookup Cache	Flat File Pipeline Relational	Indicates to use a dynamic lookup cache. Inserts or updates rows in the lookup cache as it passes rows to the target table. Use with the lookup cache enabled.
Output Old Value On Update	Flat File Pipeline Relational	Use with dynamic caching enabled. When you enable this property, the Integration Service outputs old values out of the lookup/output ports. When the Integration Service updates a row in the cache, it outputs the value that existed in the lookup cache before it updated the row based on the input data. When the Integration Service inserts a row in the cache, it outputs null values. When you disable this property, the Integration Service outputs the same values out of the lookup/output and input/output ports. This property is enabled by default.
Update Dynamic Cache Condition	Flat File Pipeline Relational	An expression that indicates whether to update dynamic cache. Create an expression using lookup ports or input ports. The expression can contain input values or values in the lookup cache. The Integration Service updates the cache when the condition is true and the data exists in the cache. Use with dynamic caching enabled. Default is true.
Cache File Name Prefix	Flat File Pipeline Relational	Use with persistent lookup cache. Specifies the file name prefix to use with persistent lookup cache files. The Integration Service uses the file name prefix as the file name for the persistent cache files it saves to disk. Enter the prefix. Do not enter .idx or .dat. You can enter a parameter or variable for the file name prefix. Use any parameter or variable type that you can define in the parameter file. If the named persistent cache files exist, the Integration Service builds the memory cache from the files. If the named persistent cache files do not exist, the Integration Service rebuilds the persistent cache files.

Option	Lookup Type	Description
Re-cache from lookup source	Flat File Pipeline Relational	Use with persistent lookup cache. If you use a persistent lookup cache and enable this option, the Integration Service rebuilds the persistent lookup cache from the lookup source when it first calls the Lookup transformation instance. If you do not enable this option, the Integration Service reuses the persisted cache files.
Insert Else Update	Flat File Pipeline Relational	Use with dynamic caching enabled. Applies to rows entering the Lookup transformation with the row type of insert. When enabled, the Integration Service inserts rows in the cache and updates existing rows. When disabled, the Integration Service does not update existing rows.
Update Else Insert	Flat File Pipeline Relational	Use with dynamic caching enabled. Applies to rows entering the Lookup transformation with the row type of update. When enabled, the Integration Service updates existing rows, and inserts a row if it is new. When disabled, the Integration Service does not insert new rows.
Datetime Format	Flat File	Click the Open button to select a datetime format. Define the format and the field width. Milliseconds, microseconds, or nanoseconds formats have a field width of 29. If you do not select a datetime format for a port, you can enter any datetime format. Default is MM/DD/YYYY HH24:MI:SS. The Datetime format does not change the size of the port.
Thousand Separator	Flat File	If you do not define a thousand separator for a port, the Integration Service uses the properties defined here. You can choose no separator, a comma, or a period. Default is no separator.
Decimal Separator	Flat File	If you do not define a decimal separator for a particular field in the lookup definition or on the Ports tab, the Integration Service uses the properties defined here. You can choose a comma or a period decimal separator. Default is period.
Case-Sensitive String Comparison	Flat File Pipeline	The Integration Service uses case sensitive string comparisons when performing lookups on string columns. For relational lookups, the case sensitive comparison depends on the database support.
Null Ordering	Flat File Pipeline	Determines how the Integration Service orders null values. You can choose to sort null values high or low. By default, the Integration Service sorts null values high. This overrides the Integration Service configuration to treat nulls in comparison operators as high, low, or null. For relational lookups, null ordering depends on the database default value.
Sorted Input	Flat File Pipeline	Indicates whether or not the lookup file data is in sorted order. This increases lookup performance for file lookups. If you enable sorted input, and the condition columns are not grouped, the Integration Service fails the session. If the condition columns are grouped, but not sorted, the Integration Service processes the lookup as if you did not configure sorted input.

Option	Lookup Type	Description
Lookup Source is Static	Flat File Pipeline Relational	The lookup source does not change in a session.
Pre-build Lookup Cache	Flat File Pipeline Relational	<p>Allows the Integration Service to build the lookup cache before the Lookup transformation receives the data. The Integration Service can build multiple lookup cache files at the same time to improve performance.</p> <p>You can configure this option in the mapping or the session. The Integration Service uses the session-level setting if you configure the Lookup transformation option as Auto.</p> <p>Configure one of the following options:</p> <ul style="list-style-type: none"> - Auto. The Integration Service uses the value configured in the session. - Always allowed. The Integration Service can build the lookup cache before the Lookup transformation receives the first source row. The Integration Service creates an additional pipeline to build the cache. - Always disallowed. The Integration Service cannot build the lookup cache before the Lookup transformation receives the first row. <p>You must configure the number of pipelines that the Integration Service can build concurrently. Configure the Additional Concurrent Pipelines for Lookup Cache Creation session property. The Integration Service can pre-build lookup cache if this property is greater than zero.</p>
Subsecond Precision	Relational	<p>Specifies the subsecond precision for datetime ports.</p> <p>For relational lookups, you can change the precision for databases that have an editable scale for datetime data. You can change subsecond precision for Oracle Timestamp, Informix Datetime, and Teradata Timestamp datatypes.</p> <p>Enter a positive integer value from 0 to 9. Default is 6 microseconds. If you enable pushdown optimization, the database returns the complete datetime value, regardless of the subsecond precision setting.</p>

Configuring Lookup Properties in a Session

When you configure a session, you can configure lookup properties that are unique to sessions:

- **Flat file lookups.** Configure lookup location information, such as the source file directory, file name, and the file type.
- **Relational lookups.** You can define \$Source and \$Target variables in the session properties. You can also override connection information to use the \$DBCConnectionName or \$AppConnectionName session parameter.
- **Pipeline lookups.** Configure the lookup source file properties such as the source file directory, file name, and the file type. If the source is a relational table or application source, configure the connection information.

Configuring Flat File Lookups in a Session

When you configure a flat file lookup in a session, configure the lookup source file properties on the Transformation View of the Mapping tab. Choose the Lookup transformation and configure the flat file properties in the session properties for the transformation.

The following table describes the session properties you configure for flat file lookups:

Property	Description
Lookup Source File Directory	<p>Enter the directory name. By default, the Integration Service looks in the process variable directory, <code>\$PMLookupFileDir</code>, for lookup files.</p> <p>You can enter the full path and file name. If you specify both the directory and file name in the Lookup Source Filename field, clear this field. The Integration Service concatenates this field with the Lookup Source Filename field when it runs the session.</p> <p>You can also enter the <code>\$InputFileName</code> session parameter to configure the file name.</p>
Lookup Source Filename	<p>Name of the lookup file. If you use an indirect file, enter the name of the indirect file you want the Integration Service to read.</p> <p>You can also enter the lookup file parameter, <code>\$LookupFileName</code>, to change the name of the lookup file for the session.</p> <p>If you configure both the directory and file name in the Source File Directory field, clear Lookup Source Filename. The Integration Service concatenates Lookup Source Filename with the Lookup Source File Directory field for the session. For example, the Lookup Source File Directory field contains "C:\lookup_data\" and the Lookup Source Filename field contains "filename.txt." When the Integration Service begins the session, it looks for "C:\lookup_data\filename.txt."</p>
Lookup Source Filetype	<p>Indicates whether the lookup source file contains the source data or a list of files with the same file properties. Choose Direct if the lookup source file contains the source data. Choose Indirect if the lookup source file contains a list of files.</p> <p>When you select Indirect, the Integration Service creates one cache for all files. If you use sorted input with indirect files, verify that the range of data in the files do not overlap. If the range of data overlaps, the Integration Service processes the lookup as an unsorted lookup source.</p>

Configuring Relational Lookups in a Session

When you configure a relational lookup in a session, configure the connection for the lookup database on the Transformation View of the Mapping tab. Choose the Lookup transformation and configure the connection in the session properties for the transformation.

Choose from the following options to configure a connection for a relational Lookup transformation:

- Choose a relational or application connection.
- Configure a database connection using the `$Source` or `$Target` connection variable.
- Configure the session parameter `$DBConnectionName` or `$AppConnectionName`, and define the session parameter in a parameter file.

Configuring Pipeline Lookups in a Session

When you configure a pipeline Lookup in a session, configure the location of lookup source file or the connection for the lookup table on the Sources node of the Mapping tab. Choose the Source Qualifier that represents the lookup source.

Lookup Query

The Integration Service queries the lookup based on the ports and properties you configure in the Lookup transformation. The Integration Service runs a default lookup query when the first row enters the Lookup transformation.

If you use a relational lookup or a pipeline lookup against a relational table, you can override the lookup query. You can use the override to change the ORDER BY clause, add a WHERE clause, or transform the lookup data before it is cached.

If you configure a SQL override and a filter on the lookup query, the Integration Service ignores the filter.

Default Lookup Query

The default lookup query contains the following statements:

SELECT

The SELECT statement includes all the lookup ports in the mapping. To view the SELECT statement for the lookup query, select the Lookup SQL Override property.

ORDER BY

The ORDER BY clause orders the columns in the same order they appear in the Lookup transformation. The Integration Service generates the ORDER BY clause. You cannot view this when you generate the default SQL.

Overriding the Lookup Query

The lookup SQL override is similar to entering a custom query in a Source Qualifier transformation. You can override the lookup query for a relational lookup. You can enter the entire override, or you can generate and edit the default SQL statement. When the Designer generates the default SQL statement for the lookup SQL override, it includes the lookup/output ports in the lookup condition and the lookup/return port.

You can enter a different lookup query or edit the existing lookup query, which includes the lookup ports, output ports, and the return port.

Overriding the ORDER BY Clause

By default, the Integration Service generates an ORDER BY clause for a cached lookup. The ORDER BY clause contains all lookup condition ports. To increase performance, you can suppress the default ORDER BY clause and enter an override ORDER BY with fewer columns.

Note: The override SQL must return data sorted on the lookup keys. When the transformation retrieves all rows in a lookup, the Integration Service builds the data cache with the keys in sorted order. The Integration Service cannot retrieve all the rows from the cache if the rows are not sorted. If the data is not sorted on the keys, you might get unexpected results.

If you use pushdown optimization, you cannot override the ORDER BY clause or suppress the generated ORDER BY clause with a comment notation.

The Integration Service always generates an ORDER BY clause, even if you enter one in the override. Place two dashes '--' after the ORDER BY override to suppress the generated ORDER BY clause. For example, a Lookup transformation uses the following lookup condition:

```
ITEM_ID = IN_ITEM_ID
PRICE <= IN_PRICE
```

The Lookup transformation includes two lookup condition ports used in the mapping, ITEM_ID, and PRICE. When you enter the ORDER BY clause with one or more columns, enter the columns in the same order as the ports in the lookup condition. You must also enclose all database reserved words in quotes. Enter the following lookup query in the lookup SQL override:

```
SELECT ITEMS_DIM.ITEM_NAME AS ITEM_NAME, ITEMS_DIM.PRICE AS PRICE, ITEMS_DIM.ITEM_ID AS  
ITEM_ID FROM ITEMS_DIM ORDER BY ITEMS_DIM.ITEM_ID --
```

To override the default ORDER BY clause for a relational lookup, complete the following steps:

1. Generate the lookup query in the Lookup transformation.
2. Enter an ORDER BY clause that contains the condition ports in the same order they appear in the Lookup condition.
3. Place two dashes '--' as a comment notation after the ORDER BY clause to suppress the ORDER BY clause that the Integration Service generates.

If you override the lookup query with an ORDER BY clause without adding comment notation, the lookup fails.

Note: Sybase has a 16 column ORDER BY limitation. If the Lookup transformation has more than 16 lookup/output ports including the ports in the lookup condition, override the ORDER BY clause or use multiple Lookup transformations to query the lookup table.

Reserved Words

If any lookup name or column name contains a database reserved word, such as MONTH or YEAR, the session fails with database errors when the Integration Service executes SQL against the database. You can create and maintain a reserved words file, reswords.txt, in the Integration Service installation directory.

You can create and maintain a reserved words file, reswords.txt, in the Integration Service installation directory. When the Integration Service initializes a session, it searches the reswords.txt file and places quotes around reserved words, and then executes the SQL against source, target, and lookup databases.

You might need to enable some databases, such as Microsoft SQL Server and Sybase, to use SQL-92 standards regarding quoted identifiers. Use connection environment SQL to issue the command. For example, with Microsoft SQL Server, use the following command:

```
SET QUOTED_IDENTIFIER ON
```

Guidelines for Overriding the Lookup Query

Certain rules and guidelines apply when you override a lookup query.

Consider the following guidelines when you override the lookup SQL query:

- You can override the lookup SQL query for relational lookups.
- Generate the default query, and then configure the override. This ensures that all the lookup/output ports are included in the query. If you add or subtract ports from the SELECT statement, the session fails.
- Add a source lookup filter to filter the rows that are added to the lookup cache. This ensures that the Integration Service inserts rows in the dynamic cache and target table that match the WHERE clause.
- If multiple Lookup transformations share a lookup cache, use the same lookup SQL override for each Lookup transformation.
- When you configure a Lookup transformation that returns all rows, the Integration Service builds the lookup cache with sorted keys. When the transformation retrieves all rows in a lookup, the Integration Service builds the data cache with the keys in sorted order. The Integration Service cannot retrieve all the rows from the cache if the rows are not sorted. If the data is not sorted on the keys, you might get unexpected results.

- The ORDER BY clause must contain the condition ports in the same order they appear in the Lookup condition.
- If you override the ORDER BY clause, use the comment notation to suppress the ORDER BY clause that the Lookup transformation generates.
- If you use pushdown optimization, you cannot override the ORDER BY clause or suppress the generated ORDER BY clause with comment notation.
- If a table name or column name in the lookup query contains a reserved word, enclose the reserved word in quotes.
- To override the lookup query for an uncached lookup, choose to return any value when the Integration Service finds multiple matches.
- You cannot add or delete any columns from the default SQL statement.

Steps to Overriding the Lookup Query

Use the following steps to override the default lookup SQL query:

1. On the Properties tab, open the SQL Editor from within the Lookup SQL Override field.
2. Click Generate SQL to generate the default SELECT statement. Enter the lookup SQL override.
3. Connect to a database, and click Validate to test the lookup SQL override.
4. Click OK to return to the Properties tab.

SQL Override for Uncached Lookup

You can define a SQL override for uncached lookups. The Integration Service does not build a cache from the override statement for an uncached lookup. You can use SQL functions in the override SELECT statement. You can override all of the SQL query including the WHERE and ORDER BY clause.

When you generate the default SELECT statement, the Designer generates a SELECT statement that includes the lookup and output ports and the WHERE clause based on the lookup condition. If the Lookup transformation is an unconnected lookup, the SELECT statement includes the lookup ports and the return port. The Integration Service does not generate the WHERE clause from the condition that you configure in the Condition tab of the Lookup transformation.

Each column in the SELECT query uses an alias to define the output column. Do not change this syntax in the SQL statement, or the query fails. To reference input ports in the WHERE clause, configure parameter binding. The following example includes a WHERE statement that references the Name port:

```
SELECT EMPLOYEE.NAME as NAME, max(EMPLOYEE.ID) as ID from EMPLOYEE WHERE EMPLOYEE.NAME=?
NAME1?
```

The SQL Editor for uncached lookup displays the input ports and the lookup ports on the Ports tab.

If you add a function to the SQL statement, the return datatype must match the datatype of the ALIAS column. For example, the datatype of ID matches the return type of the MAX function:

```
SELECT EMPLOYEE.NAME as NAME, MAX(EMPLOYEE.ID) as ID FROM EMPLOYEE
```

Note: You cannot use subqueries in the SQL override for uncached lookups.

Lookup Source Filter

You can configure a Lookup source filter for a relational Lookup transformation that has caching enabled. Add the lookup source filter to limit the number of lookups that the Integration Service performs on a lookup source table.

When you configure a Lookup source filter, the Integration Service performs lookups based on the results of the filter statement. For example, you might need to retrieve the last name of every employee whose ID is greater than 510.

You configure the following lookup source filter on the EmployeeID column:

```
EmployeeID >= 510
```

EmployeeID is an input port in the Lookup transformation. When the Integration Service reads the source row, it performs a lookup on the cache when the value of EmployeeID is greater than 510. When EmployeeID is less than or equal to 510, the Lookup transformation does not retrieve the last name.

When you add a lookup source filter to the Lookup query for a session configured for pushdown optimization, the Integration Service creates a view to represent the SQL override. The Integration Service runs an SQL query against this view to push the transformation logic to the database.

Filtering Lookup Source Rows

Add the lookup source filter to limit the number of lookups that the Integration Service performs on a relational lookup source.

1. In the Mapping Designer or Transformation Developer, open the Lookup transformation.
2. Select the **Properties** tab.
3. Verify that caching is enabled.
4. Click the **Open** button in the **Lookup Source Filter** field.
5. In the SQL Editor, select the input ports or enter any Lookup transformation port that you want to filter.
6. Enter a filter condition.
Do not include the keyword WHERE in the filter condition. Enclose string mapping parameters and variables in string identifiers.
7. To validate the condition, select the ODBC data source that has the source included in the query.
8. Enter the user name and the password to connect to this database.
9. Click **Validate**.

The Designer runs the query and reports whether its syntax is correct.

Lookup Condition

The Integration Service finds data in the lookup source with a lookup condition. The lookup condition is similar to the WHERE clause in an SQL query. When you configure a lookup condition in a Lookup transformation, you compare the value of one or more columns in the source data with values in the lookup source or cache.

For example, the source data contains an employee_number. The lookup source table contains employee_ID, first_name, and last_name. You configure the following lookup condition:

```
employee_ID = employee_number
```

For each `employee_number`, the Integration Service returns the `employee_ID`, `last_name`, and `first_name` column from the lookup source.

The Integration Service can return more than one row from the lookup source. You configure the following lookup condition:

```
employee_ID > employee_number
```

The Integration Service returns rows for all `employee_ID` numbers greater than the source employee number.

Use the following guidelines when you enter a condition for a Lookup transformation:

- The datatypes for the columns in a lookup condition must match.
- You must enter a lookup condition in all Lookup transformations.
- Use one input port for each lookup port in the lookup condition. Use the same input port in more than one condition in a transformation.
- When you enter multiple conditions, the Integration Service evaluates each condition as an AND, not an OR. The Integration Service returns rows that match all the conditions you configure.
- If you include multiple conditions, enter the conditions in the following order to optimize lookup performance:
 - Equal to (=)
 - Less than (<), greater than (>), less than or equal to (<=), greater than or equal to (>=)
 - Not equal to (!=)
- The Integration Service matches null values. For example, if an input lookup condition column is NULL, the Integration Service evaluates the NULL equal to a NULL in the lookup.
- If you configure a flat file lookup for sorted input, the Integration Service fails the session if the condition columns are not grouped. If the columns are grouped, but not sorted, the Integration Service processes the lookup as if you did not configure sorted input.

The Integration Service processes lookup matches differently depending on whether you configure the transformation for a dynamic cache or an uncached or static cache.

Uncached or Static Cache

Use the following guidelines when you configure a Lookup transformation that has a static lookup cache or an uncached lookup source:

- Use the following operators when you create the lookup condition:

```
=, >, <, >=, <=, !=
```

If you include more than one lookup condition, place the conditions in the following order to optimize lookup performance:

- Equal to (=)
- Less than (<), greater than (>), less than or equal to (<=), greater than or equal to (>=)
- Not equal to (!=)

For example, create the following lookup condition:

```
ITEM_ID = IN_ITEM_ID  
PRICE <= IN_PRICE
```

- The input value must meet all conditions for the lookup to return a value.

The condition can match equivalent values or supply a threshold condition. For example, you might look for customers who do not live in California, or employees whose salary is greater than \$30,000. Depending on the nature of the source and condition, the lookup might return multiple values.

Dynamic Cache

If you configure a Lookup transformation to use a dynamic cache, you can use only the equality operator (=) in the lookup condition.

Handling Multiple Matches

The Lookup transformation finds values based on the condition you configure in the transformation. If the lookup condition is not based on a unique key, or if the lookup source is denormalized, the Integration Service might find multiple matches in the lookup source or the lookup cache.

You can configure a Lookup transformation to handle multiple matches in the following ways:

- **Use the first matching value, or use the last matching value.** You can configure the transformation to return the first matching value or the last matching value. The first and last values are the first value and last value found in the lookup cache that match the lookup condition. When you cache the lookup source, the Integration Service generates an ORDER BY clause for each column in the lookup cache to determine the first and last row in the cache. The Integration Service then sorts each lookup source column in ascending order.

The Integration Service sorts numeric columns in ascending numeric order such as 0 to 10. It sorts date/time columns from January to December and from the first of the month to the end of the month. The Integration Service sorts string columns based on the sort order configured for the session.

- **Use any matching value.** You can configure the Lookup transformation to return any value that matches the lookup condition. When you configure the Lookup transformation to return any matching value, the transformation returns the first value that matches the lookup condition. The transformation creates an index based on the key ports instead of all Lookup transformation ports. When you use any matching value, performance can improve because the process of indexing rows is simpler.
- **Use all values.** The Lookup transformation returns all matching rows. To use this option, you must configure the Lookup transformation to return all matches when you create the transformation. The transformation becomes an active transformation. You cannot change the mode between passive and active after you create the transformation.
- **Return an error.** When the Lookup transformation uses a static cache or no cache, the Integration Service marks the row as an error. The Lookup transformation writes the row to the session log by default, and increases the error count by one. When the Lookup transformation has a dynamic cache, the Integration Service fails the session when it encounters multiple matches. The session fails while the Integration Service is caching the lookup table or looking up the duplicate key values. Also, if you configure the Lookup transformation to output old values on updates, the Lookup transformation returns an error when it encounters multiple matches. The transformation creates an index based on the key ports instead of all Lookup transformation ports.

RELATED TOPICS:

- [“Return Multiple Rows” on page 300](#)

Lookup Caches

You can configure a Lookup transformation to cache the lookup file or table. The Integration Service builds a cache in memory when it processes the first row of data in a cached Lookup transformation. It allocates memory for the cache based on the amount you configure in the transformation or session properties. The

Integration Service stores condition values in the index cache and output values in the data cache. The Integration Service queries the cache for each row that enters the transformation.

The Integration Service also creates cache files by default in the \$PMCacheDir. If the data does not fit in the memory cache, the Integration Service stores the overflow values in the cache files. When the session completes, the Integration Service releases cache memory and deletes the cache files unless you configure the Lookup transformation to use a persistent cache.

When configuring a lookup cache, you can configure the following options:

- Persistent cache
- Recache from lookup source
- Static cache
- Dynamic cache
- Shared cache
- Pre-build lookup cache

Note: You can use a dynamic cache for relational or flat file lookups.

Return Multiple Rows

When you configure the Lookup transformation to return all matching rows, the Lookup transformation returns all rows that match the lookup condition. You must configure the transformation to return all matching rows when you create the transformation. The Lookup transformation becomes an active transformation. The Lookup Policy on Multiple Match property is Use All Values. The property becomes read-only. You cannot change the property after you create the transformation.

You might have customer order data in a relational table. Each customer has multiple orders in the table. You can configure the Lookup transformation to return all the orders for a customer from a lookup. You can cache the lookup table to improve performance.

If you configure the Lookup transformation for caching, the Integration Service caches all rows that it reads from the lookup source. The Integration Service caches all rows for a lookup key by the key index.

Rules and Guidelines for Returning Multiple Rows

Use the following rules and guidelines when you configure the Lookup transformation to return multiple rows:

- The Integration Service caches all rows from the lookup source for cached lookups.
- You can configure an SQL override for a cached or uncached lookup that returns multiple rows. The override SQL must return data sorted on the lookup keys. If the data is not sorted on the keys, you might get unexpected results.
- You cannot enable dynamic cache for a Lookup transformation that returns multiple rows.
- You cannot return multiple rows from an unconnected Lookup transformation.
- You can configure multiple Lookup transformations to share a named cache if the Lookup transformations have matching cache lookup on multiple match policies.
- A Lookup transformation that returns multiple rows cannot share a cache with a Lookup transformation that returns one matching row for each input row.

RELATED TOPICS:

- [“Creating a Lookup Transformation” on page 303](#)

Configuring Unconnected Lookup Transformations

An unconnected Lookup transformation is a Lookup transformation that is not connected to a source or target. Call the lookup from another transformation with a :LKP expression.

You can perform the following tasks when you call a lookup from an expression:

- Test the results of a lookup in an expression.
- Filter rows based on the lookup results.
- Mark rows for update based on the result of a lookup and update slowly changing dimension tables.
- Call the same lookup multiple times in one mapping.

To configure an unconnected Lookup transformation, add input ports, configure the lookup condition, designate a return value, and configure a lookup expression in a different transformation.

Step 1. Add Input Ports

Create an input port in the Lookup transformation for each argument in the :LKP expression. For each lookup condition you plan to create, you need to add an input port to the Lookup transformation. You can create a different port for each condition, or use the same input port in more than one condition.

For example, a retail store increased prices across all departments during the last month. The accounting department only wants to load rows into the target for items with increased prices. To accomplish this, complete the following tasks:

- Create a lookup condition that compares the ITEM_ID in the source with the ITEM_ID in the target.
- Compare the PRICE for each item in the source with the price in the target table.
 - If the item exists in the target table and the item price in the source is less than or equal to the price in the target table, you want to delete the row.
 - If the price in the source is greater than the item price in the target table, you want to update the row.
- Create an input port (IN_ITEM_ID) with datatype Decimal (37,0) to match the ITEM_ID and an IN_PRICE input port with Decimal (10,2) to match the PRICE lookup port.

Step 2. Add the Lookup Condition

After you configure the ports, define a lookup condition to compare transformation input values with values in the lookup source or cache. To increase performance, add conditions with an equal sign first.

In this case, add the following lookup condition:

```
ITEM_ID = IN_ITEM_ID  
  
PRICE <= IN_PRICE
```

If the item exists in the mapping source and lookup source and the mapping source price is less than or equal to the lookup price, the condition is true and the lookup returns the values designated by the Return port. If the lookup condition is false, the lookup returns NULL. When you write the update strategy expression, use ISNULL nested in an IIF function to test for null values.

Step 3. Designate a Return Value

You can pass multiple input values into a Lookup transformation and return one column of data. Do not configure the lookup policy to use all values on multiple matches for an unconnected Lookup transformation. Designate one lookup/output port as a return port. You can choose to use the first, last, or any value that matches the lookup condition.

If you call the unconnected lookup from an update strategy or filter expression, you are generally checking for null values. In this case, the return port can be anything. If you call the lookup from an expression performing a calculation, the return value needs to be the value you want to include in the calculation.

To continue the update strategy example, you can define the ITEM_ID port as the return port. The update strategy expression checks for null values returned. If the lookup condition is true, the Integration Service returns the ITEM_ID. If the condition is false, the Integration Service returns NULL.

The following figure shows a return port in a Lookup transformation:

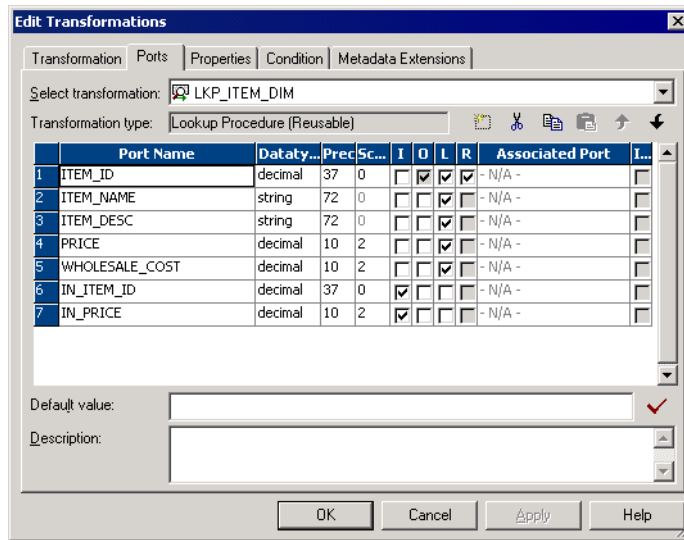

Step 4. Call the Lookup Through an Expression

Supply input values for an unconnected Lookup transformation from a :LKP expression in another transformation. The arguments are local input ports that match the Lookup transformation input ports used in the lookup condition. Use the following syntax for a :LKP expression:

```
:LKP.lookup_transformation_name(argument, argument, ...)
```

To continue the example about the retail store, when you write the update strategy expression, the order of ports in the expression must match the order in the lookup condition. In this case, the ITEM_ID condition is the first lookup condition, and therefore, it is the first argument in the update strategy expression.

```
IIF(ISNULL(:LKP.lkpITEMS_DIM(ITEM_ID, PRICE)), DD_UPDATE, DD_REJECT)
```

Use the following guidelines to write an expression that calls an unconnected Lookup transformation:

- The order in which you list each argument must match the order of the lookup conditions in the Lookup transformation.
- The datatypes for the ports in the expression must match the datatypes for the input ports in the Lookup transformation. The Designer does not validate the expression if the datatypes do not match.
- If one port in the lookup condition is not a lookup/output port, the Designer does not validate the expression.

- The argument ports in the expression must be in the same order as the input ports in the lookup condition.
- If you use incorrect :LKP syntax, the Designer marks the mapping invalid.
- If you call a connected Lookup transformation in a :LKP expression, the Designer marks the mapping invalid.

Tip: Avoid syntax errors when you enter expressions by using the point-and-click method to select functions and ports.

Database Deadlock Resilience

The Lookup transformation is resilient to a database deadlock for uncached lookups. When a database deadlock error occurs, the session does not fail. The Integration Service attempts to re-execute the last statement for a specified retry period.

You can configure the number of deadlock retries and the deadlock sleep interval for an Integration Service. These values also affect database deadlocks for the relational writer. You can override these values at the session level as custom properties.

Configure following Integration Service Properties:

- **NumOfDeadlockRetries.** The number of times the PowerCenter Integration Service retries a target write on a database deadlock. Minimum is 0. Default is 10. If you want the session to fail on deadlock set NumOfDeadlockRetries to zero.
- **DeadlockSleep.** Number of seconds before the PowerCenter Integration Service retries a target write on database deadlock.

If a deadlock occurs, the Integration Service attempts to run the statement. The Integration Service waits for a delay period between each retry attempt. If all attempts fail due to deadlock, the session fails. The Integration Service logs a message in the session log whenever it retries a statement.

Creating a Lookup Transformation

Create a reusable Lookup transformation in the Transformation Developer. Create a non-reusable Lookup transformation in the Mapping Designer.

To create a Lookup transformation:

1. To create a reusable Lookup transformation, open the Transformation Developer.
To create a non-reusable Lookup transformation, open a mapping in the Mapping Designer. If you are creating pipeline Lookup transformation, drag in a source definition to use as a lookup source.
2. Click Transformation > Create. Select the Lookup transformation.
3. Enter a name for the transformation. Click Create.
The naming convention for Lookup transformations is *LKP_TransformationName*.
4. Choose whether the transformation is active or passive. Click OK. You cannot change this option.

5. In the Select Lookup Table dialog box, choose one of the following options to import a lookup definition:
 - Source definition from the repository.
 - Target definition from the repository.
 - Source qualifier from the mapping.
 - Import a relational table or file from the repository.

Note: You can manually add the lookup ports instead of importing a definition. You can choose which lookup ports are also output ports.

When you choose the lookup source, the Designer creates ports in the transformation based on the ports in the object that you choose. The Designer configures each port as a lookup port and an output port. The lookup ports represent the columns in the lookup source. The Lookup transformation receives data from the lookup source in each lookup port and passes the data to the target.

6. If you want the Lookup transformation to return all matching rows, enable Return All Rows on Multiple Match. You cannot change this option after you create the transformation. The Lookup transformation becomes an active transformation.
7. Click OK or click Skip if you want to manually add the lookup ports instead of importing a definition. You can choose which lookup ports are also output ports.
8. For a connected Lookup transformation, add input and output ports.

You can pass data through the transformation and return data from the lookup table to the target.
9. For an unconnected Lookup transformation, create a return port for the value you want to return from the lookup.

You can return one column to the transformation that called the lookup.
10. Click the Properties tab to configure the Lookup transformation properties. Configure lookup caching. Lookup caching is enabled by default for pipeline and flat file Lookup transformations.
11. For a Lookup transformation that has a dynamic lookup cache, associate an input port, output port, or sequence ID with each lookup port.

The Integration Service inserts or updates rows in the lookup cache with the data from each associated expression. If you associate a sequence ID, the Integration Service generates a primary key for inserted rows in the lookup cache.
12. Add the lookup condition on the Condition tab.

The lookup condition compares the source column values with values in the lookup source. The Condition tab Transformation Port represents the source column values. The Lookup Table represents the lookup source.

RELATED TOPICS:

- [“Creating a Reusable Pipeline Lookup Transformation” on page 304](#)
- [“Creating a Non-Reusable Pipeline Lookup Transformation” on page 305](#)

Creating a Reusable Pipeline Lookup Transformation

Create a reusable pipeline Lookup transformation in the Transformation Developer. When you create the transformation, choose Source for the lookup table location. The Transformation Developer displays a list of source definitions from the repository.

When you choose a source qualifier that represents a relational table or flat file source definition, the Designer creates a relational or flat file Lookup transformation. When the source qualifier represents an application source, the Designer creates a pipeline Lookup transformation. To create a pipeline Lookup

transformation for a relational or flat file lookup source, change the source type to Source Qualifier after you create the transformation. Enter the name of the source definition in the Lookup Table property.

When you drag a reusable pipeline Lookup transformation into a mapping, the Mapping Designer adds the source definition from the Lookup Table property to the mapping. The Designer adds the Source Qualifier transformation.

To change the Lookup Table Name to another source qualifier in the mapping, click the Open button in the Lookup Table Name property. Choose a Source Qualifier from the list.

Creating a Non-Reusable Pipeline Lookup Transformation

Create a non-reusable pipeline Lookup transformation in the Mapping Designer. Drag a source definition into a mapping. When you create the transformation in the Mapping Designer, select Source Qualifier as the lookup table location. The Mapping Designer displays a list of the source qualifiers in the mapping. When you select a source qualifier, the Mapping Designer populates the Lookup transformation with port names and attributes from the source qualifier you choose.

Tips for Lookup Transformations

Add an index to the columns used in a lookup condition.

If you have privileges to modify the database containing a lookup table, you can improve performance for both cached and uncached lookups. This is important for very large lookup tables. Since the Integration Service needs to query, sort, and compare values in these columns, the index needs to include every column used in a lookup condition.

Place conditions with an equality operator (=) first.

If you include more than one lookup condition, place the conditions in the following order to optimize lookup performance:

- Equal to (=)
- Less than (<), greater than (>), less than or equal to (<=), greater than or equal to (>=)
- Not equal to (!=)

Cache small lookup tables.

Improve session performance by caching small lookup tables. The result of the lookup query and processing is the same, whether or not you cache the lookup table.

Join tables in the database.

If the lookup table is on the same database as the source table in the mapping and caching is not feasible, join the tables in the source database rather than using a Lookup transformation.

Use a persistent lookup cache for static lookups.

If the lookup source does not change between sessions, configure the Lookup transformation to use a persistent lookup cache. The Integration Service then saves and reuses cache files from session to session, eliminating the time required to read the lookup source.

Call unconnected Lookup transformations with the :LKP reference qualifier.

When you write an expression using the :LKP reference qualifier, you call unconnected Lookup transformations only. If you try to call a connected Lookup transformation, the Designer displays an error and marks the mapping invalid.

Configure a pipeline Lookup transformation to improve performance when processing a relational or flat file lookup source.

You can create partitions to process a relational or flat file lookup source when you define the lookup source as a source qualifier. Configure a non-reusable pipeline Lookup transformation and create partitions in the partial pipeline that processes the lookup source.

CHAPTER 18

Lookup Caches

This chapter includes the following topics:

- [Lookup Caches Overview, 307](#)
- [Building Connected Lookup Caches, 309](#)
- [Using a Persistent Lookup Cache, 311](#)
- [Working with an Uncached Lookup or Static Cache, 312](#)
- [Sharing the Lookup Cache, 313](#)
- [Tips for Lookup Caches, 319](#)

Lookup Caches Overview

You can configure a Lookup transformation to cache the lookup source to increase lookup performance. Enable lookup caching when the lookup table or file is large.

The Integration Service builds a cache in memory when it processes the first row of data in a cached Lookup transformation. It allocates memory for the cache based on the amount you configure in the transformation or session properties. The Integration Service stores condition values in the index cache and output values in the data cache. The Integration Service queries the cache for each row that enters the transformation.

If the data does not fit in the memory cache, the Integration Service stores the overflow values in the cache files. The Integration Service also creates cache files in the specified cache directory. When the session completes, the Integration Service releases cache memory and deletes the cache files unless you configure the Lookup transformation to use a persistent cache.

If you use a flat file lookup or pipeline lookup, the Integration Service always caches the lookup source. If you configure a flat file lookup for sorted input, the Integration Service cannot cache the lookup if the condition columns are not grouped. If the columns are grouped, but not sorted, the Integration Service processes the lookup as if you did not configure sorted input.

When you configure a lookup cache, you can configure the following cache settings:

Sequential and concurrent caches

You can configure the session to build caches sequentially or concurrently. When you build sequential caches, the Integration Service creates caches as the source rows enter the Lookup transformation.

When you configure the session to build concurrent caches, the Integration Service does not wait for the first row to enter the Lookup transformation before it creates caches. Instead, it builds multiple caches concurrently.

Persistent cache

You can save the lookup cache files and reuse them the next time the Integration Service processes a Lookup transformation configured to use the cache.

Recache from source

If the persistent cache is not synchronized with the lookup source, you can configure the Lookup transformation to rebuild the lookup cache.

Static cache

You can configure a static cache for any lookup source. By default, the Integration Service creates a static cache. It caches the lookup file or table and looks up values in the cache for each row that comes into the transformation. When the lookup condition is true, the Integration Service returns a value from the lookup cache. The Integration Service does not update the cache while it processes the Lookup transformation.

Dynamic cache

To cache a lookup source and update the cache, configure a Lookup transformation with dynamic cache. The Integration Service dynamically inserts or updates data in the lookup cache and passes the data to the target. The dynamic cache is synchronized with the target.

Shared cache

You can share the lookup cache between multiple transformations. You can share an unnamed cache between transformations in the same mapping. You can share a named cache between transformations in the same or different mappings. Lookup transformations can share unnamed static caches within the same target load order group if the cache sharing rules match. Lookup transformations cannot share dynamic cache within the same target load order group.

When you do not configure the Lookup transformation for caching, the Integration Service queries the lookup source for each input row. Whether or not you cache the lookup source, the result of the Lookup query and processing is the same. However, you can increase lookup performance on a large lookup source if you enable lookup caching.

Cache Comparison

The Integration Service performs differently based on the type of lookup cache that you configure.

The following table compares Lookup transformations with an uncached lookup, a static cache, and a dynamic cache:

Uncached	Static Cache	Dynamic Cache
The Integration Service does not insert or update the cache.	The Integration Service does not insert or update the cache.	The Integration Service can insert or update rows in the cache as it passes rows to the target.
You can use a relational lookup.	You can use a relational, flat file, or pipeline lookup.	You can use a relational, flat file, or Source Qualifier lookup.
<p>When the condition is true, the Integration Service returns a value from the lookup table or cache.</p> <p>When the condition is not true, the Integration Service returns the default value for connected transformations and NULL for unconnected transformations.</p>	<p>When the condition is true, the Integration Service returns a value from the lookup table or cache.</p> <p>When the condition is not true, the Integration Service returns the default value for connected transformations and NULL for unconnected transformations.</p>	<p>When the condition is true, the Integration Service either updates rows in the cache or leaves the cache unchanged, based on the row type. This indicates that the row is in the cache and target table. You can pass updated rows to a target.</p> <p>When the condition is not true, the Integration Service either inserts rows into the cache or leaves the cache unchanged, based on the row type. This indicates that the row is not in the cache or target. You can pass inserted rows to a target table.</p>

RELATED TOPICS:

- [“Working with an Uncached Lookup or Static Cache” on page 312](#)
- [“Dynamic Lookup Cache Updates” on page 328](#)

Building Connected Lookup Caches

The Integration Service can build lookup caches for connected Lookup transformations in the following ways:

- **Sequential caches.** The Integration Service builds lookup caches sequentially. The Integration Service builds the cache in memory when it processes the first row of the data in a cached lookup transformation.
- **Concurrent caches.** The Integration Service builds lookup caches concurrently. It does not need to wait for data to reach the Lookup transformation.

Note: The Integration Service builds caches for unconnected Lookup transformations sequentially regardless of how you configure cache building. If you configure the session to build concurrent caches for an unconnected Lookup transformation, the Integration Service ignores this setting and builds unconnected Lookup transformation caches sequentially.

Sequential Caches

By default, the Integration Service builds a cache in memory when it processes the first row of data in a cached Lookup transformation. The Integration Service creates each lookup cache in the pipeline sequentially. The Integration Service waits for any upstream active transformation to complete processing

before it starts processing the rows in the Lookup transformation. The Integration Service does not build caches for a downstream Lookup transformation until an upstream Lookup transformation completes building a cache.

For example, the following mapping contains an unsorted Aggregator transformation followed by two Lookup transformations:

Figure 2. Building Lookup Caches Sequentially

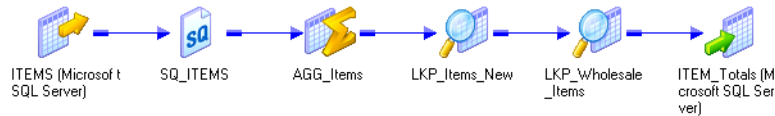

The Integration Service processes all the rows for the unsorted Aggregator transformation and begins processing the first Lookup transformation after the unsorted Aggregator transformation completes. When it processes the first input row, the Integration Service begins building the first lookup cache. After the Integration Service finishes building the first lookup cache, it can begin processing the lookup data. The Integration Service begins building the next lookup cache when the first row of data reaches the Lookup transformation.

You might want to process lookup caches sequentially if the Lookup transformation may not process row data. The Lookup transformation may not process row data if the transformation logic is configured to route data to different pipelines based on a condition. Configuring sequential caching may allow you to avoid building lookup caches unnecessarily. For example, a Router transformation might route data to one pipeline if a condition resolves to true, and it might route data to another pipeline if the condition resolves to false. In this case, a Lookup transformation might not receive data at all.

Concurrent Caches

You can configure the Integration Service to create lookup caches concurrently. You may be able to improve session performance using concurrent caches. Performance may especially improve when the pipeline contains an active transformations upstream of the Lookup transformation. You may want to configure the session to create concurrent caches if you are certain that you will need to build caches for each of the Lookup transformations in the session.

When you configure the Lookup transformation to create concurrent caches, it does not wait for upstream transformations to complete before it creates lookup caches, and it does not need to finish building a lookup cache before it can begin building other lookup caches.

The following figure shows lookup transformation caches built concurrently:

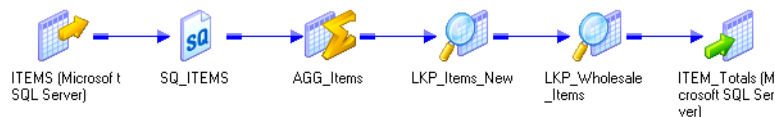

When you run the session, the Integration Service builds the Lookup caches concurrently. It does not wait for upstream transformations to complete, and it does not wait for other Lookup transformations to complete cache building.

Note: You cannot process caches for unconnected Lookup transformations concurrently.

To configure the session to create concurrent caches, configure a value for the session configuration attribute, Additional Concurrent Pipelines for Lookup Cache Creation.

Using a Persistent Lookup Cache

You can configure a Lookup transformation to use a non-persistent or persistent cache. The Integration Service saves or deletes lookup cache files after a successful session based on the Lookup Cache Persistent property.

If the lookup table does not change between sessions, you can configure the Lookup transformation to use a persistent lookup cache. The Integration Service saves and reuses cache files from session to session, eliminating the time required to read the lookup table.

Using a Non-Persistent Cache

By default, the Integration Service uses a non-persistent cache when you enable caching in a Lookup transformation. The Integration Service deletes the cache files at the end of a session. The next time you run the session, the Integration Service builds the memory cache from the database.

Using a Persistent Cache

If you want to save and reuse the cache files, you can configure the transformation to use a persistent cache. Use a persistent cache when you know the lookup table does not change between session runs.

The first time the Integration Service runs a session using a persistent lookup cache, it saves the cache files to disk instead of deleting them. The next time the Integration Service runs the session, it builds the memory cache from the cache files. If the lookup table changes occasionally, you can override session properties to recache the lookup from the database.

When you use a persistent lookup cache, you can specify a name for the cache files. When you specify a named cache, you can share the lookup cache across sessions.

Rebuilding the Lookup Cache

You can instruct the Integration Service to rebuild the lookup cache if you think that the lookup source changed since the last time the Integration Service built the persistent cache.

When you rebuild a cache, the Integration Service creates new cache files, overwriting existing persistent cache files. The Integration Service writes a message to the session log when it rebuilds the cache.

You can rebuild the cache when the mapping contains one Lookup transformation or when the mapping contains Lookup transformations in multiple target load order groups that share a cache. You do not need to rebuild the cache when a dynamic lookup shares the cache with a static lookup in the same mapping.

If the Integration Service cannot reuse the cache, it either recaches the lookup from the database, or it fails the session, depending on the mapping and session properties.

The following table summarizes how the Integration Service handles persistent caching for named and unnamed caches:

Mapping or Session Changes Between Sessions	Named Cache	Unnamed Cache
Integration Service cannot locate cache files. For example, the file no longer exists or the Integration Service runs on a grid and the cache file is not available to all nodes.	Rebuilds cache.	Rebuilds cache.
Enable or disable the Enable High Precision option in session properties.	Fails session.	Rebuilds cache.
Edit the transformation in the Mapping Designer, Maplet Designer, or Reusable Transformation Developer. ¹	Fails session.	Rebuilds cache.
Edit the mapping (excluding Lookup transformation).	Reuses cache.	Rebuilds cache.
Change the number of partitions in the pipeline that contains the Lookup transformation.	Fails session.	Rebuilds cache.
Change database connection or the file location used to access the lookup table.	Fails session.	Rebuilds cache.
Change the Integration Service data movement mode.	Fails session.	Rebuilds cache.
Change the sort order in Unicode mode.	Fails session.	Rebuilds cache.
Change the Integration Service code page to a compatible code page.	Reuses cache.	Reuses cache.
Change the Integration Service code page to an incompatible code page.	Fails session.	Rebuilds cache.

¹ Editing properties such as transformation description or port description does not affect persistent cache handling.

Working with an Uncached Lookup or Static Cache

By default, the Integration Service creates a static lookup cache when you configure a Lookup transformation for caching. The Integration Service builds the cache when it processes the first lookup request. It queries the cache based on the lookup condition for each row that passes into the transformation. The Integration Service does not update the cache while it processes the transformation. The Integration Service processes an uncached lookup the same way it processes a cached lookup except that it queries the lookup source instead of building and querying the cache.

When the lookup condition is true, the Integration Service returns the values from the lookup source or cache. For connected Lookup transformations, the Integration Service returns the values represented by the lookup/output ports. For unconnected Lookup transformations, the Integration Service returns the value represented by the return port.

When the condition is not true, the Integration Service returns either NULL or default values. For connected Lookup transformations, the Integration Service returns the default value of the output port when the condition is not met. For unconnected Lookup transformations, the Integration Service returns NULL when the condition is not met.

When you create multiple partitions in a pipeline that use a static cache, the Integration Service creates one memory cache for each partition and one disk cache for each transformation.

Sharing the Lookup Cache

You can configure multiple Lookup transformations in a mapping to share a single lookup cache. The Integration Service builds the cache when it processes the first Lookup transformation. It uses the same cache to perform lookups for subsequent Lookup transformations that share the cache.

You can share caches that are unnamed and named:

- **Unnamed cache.** When Lookup transformations in a mapping have compatible caching structures, the Integration Service shares the cache by default. You can only share static unnamed caches.
- **Named cache.** Use a persistent named cache when you want to share a cache file across mappings or share a dynamic and a static cache. The caching structures must match or be compatible with a named cache. You can share static and dynamic named caches.

When the Integration Service shares a lookup cache, it writes a message in the session log.

Sharing an Unnamed Lookup Cache

By default, the Integration Service shares the cache for Lookup transformations in a mapping that have compatible caching structures. For example, if you have two instances of the same reusable Lookup transformation in one mapping and you use the same output ports for both instances, the Lookup transformations share the lookup cache by default.

When two Lookup transformations share an unnamed cache, the Integration Service saves the cache for a Lookup transformation and uses it for subsequent Lookup transformations that have the same lookup cache structure.

If the transformation properties or the cache structure do not allow sharing, the Integration Service creates a new cache.

Guidelines for Sharing an Unnamed Lookup Cache

Use the following guidelines when you configure Lookup transformations to share an unnamed cache:

- You can share static unnamed caches.
- Shared transformations must use the same ports in the lookup condition. The conditions can use different operators, but the ports must be the same.
- You must configure some of the transformation properties to enable unnamed cache sharing.
- The structure of the cache for the shared transformations must be compatible.
 - If you use hash auto-keys partitioning, the lookup/output ports for each transformation must match.
 - If you do not use hash auto-keys partitioning, the lookup/output ports for the first shared transformation must match or be a superset of the lookup/output ports for subsequent transformations.
- If the Lookup transformations with hash auto-keys partitioning are in different target load order groups, you must configure the same number of partitions for each group. If you do not use hash auto-keys partitioning, you can configure a different number of partitions for each target load order group.

The following table shows when you can share an unnamed static and dynamic cache:

Shared Cache	Location of Transformations
Static with Static	Anywhere in the mapping.
Dynamic with Dynamic	Cannot share.
Dynamic with Static	Cannot share.

The following table describes the guidelines to follow when you configure Lookup transformations to share an unnamed cache:

Properties	Configuration for Unnamed Shared Cache
Lookup SQL Override	If you use the Lookup SQL Override property, you must use the same override in all shared transformations.
Lookup Table Name	Must match.
Lookup Caching Enabled	Must be enabled.
Lookup Policy on Multiple Match	-
Lookup Condition	Shared transformations must use the same ports in the lookup condition. The conditions can use different operators, but the ports must be the same.
Connection Information	The connection must be the same. When you configure the sessions, the database connection must match.
Source Type	Must match.
Tracing Level	-
Lookup Cache Directory Name	Does not need to match.
Lookup Cache Persistent	Optional. You can share persistent and non-persistent.
Lookup Data Cache Size	Integration Service allocates memory for the first shared transformation in each pipeline stage. It does not allocate additional memory for subsequent shared transformations in the same pipeline stage.
Lookup Index Cache Size	Integration Service allocates memory for the first shared transformation in each pipeline stage. It does not allocate additional memory for subsequent shared transformations in the same pipeline stage.
Dynamic Lookup Cache	You cannot share an unnamed dynamic cache.
Output Old Value On Update	Does not need to match.
Cache File Name Prefix	Do not use. You cannot share a named cache with an unnamed cache.

Properties	Configuration for Unnamed Shared Cache
Recache From Lookup Source	<p>If you configure a Lookup transformation to recache from source, subsequent Lookup transformations in the target load order group can share the existing cache whether or not you configure them to recache from source. If you configure subsequent Lookup transformations to recache from source, the Integration Service shares the cache instead of rebuilding the cache when it processes the subsequent Lookup transformation.</p> <p>If you do not configure the first Lookup transformation in a target load order group to recache from source, and you do configure the subsequent Lookup transformation to recache from source, the transformations cannot share the cache. The Integration Service builds the cache when it processes each Lookup transformation.</p>
Lookup/Output Ports	The lookup/output ports for the second Lookup transformation must match or be a subset of the ports in the transformation that the Integration Service uses to build the cache. The order of the ports do not need to match.
Insert Else Update	-
Update Else Insert	-
Datetime Format	-
Thousand Separator	-
Decimal Separator	-
Case-Sensitive String Comparison	Must match.
Null Ordering	Must match.
Sorted Input	-

Sharing a Named Lookup Cache

You can also share the cache between multiple Lookup transformations by using a persistent lookup cache and naming the cache files. You can share one cache between Lookup transformations in the same mapping or across mappings.

The Integration Service uses the following process to share a named lookup cache:

1. When the Integration Service processes the first Lookup transformation, it searches the cache directory for cache files with the same file name prefix.
2. If the Integration Service finds the cache files and you do not specify to recache from source, the Integration Service uses the saved cache files.
3. If the Integration Service does not find the cache files or if you specify to recache from source, the Integration Service builds the lookup cache using the database table.
4. The Integration Service saves the cache files to disk after it processes each target load order group.
5. The Integration Service uses the following rules to process the second Lookup transformation with the same cache file name prefix:
 - The Integration Service uses the memory cache if the transformations are in the same target load order group.

- The Integration Service rebuilds the memory cache from the persisted files if the transformations are in different target load order groups.
- The Integration Service rebuilds the cache from the database if you configure the transformation to recache from source and the first transformation is in a different target load order group.
- If you do not configure the first Lookup transformation in a target load order group to recache from source, and you do configure the subsequent Lookup transformation to recache from source, the Integration Service does not rebuild the cache.
- If the cache structures do not match, the Integration Service fails the session.

If you run two sessions simultaneously that share a lookup cache, the Integration Service uses the following rules to share the cache files:

- The Integration Service processes multiple sessions simultaneously when the Lookup transformations only need to read the cache files.
- The Integration Service fails the session if one session updates a cache file while another session attempts to read or update the cache file. For example, Lookup transformations update the cache file if they are configured to use a dynamic cache or recache from source.

Guidelines for Sharing a Named Lookup Cache

Use the following guidelines when you configure Lookup transformations to share a named cache:

- Do not share a lookup cache between sessions if the cache is a dynamic lookup cache or the transformation is configured to recache from the source.
- You can share a cache between dynamic and static Lookup transformations but you must follow the guidelines for the cache location.
- You must configure some of the transformation properties to enable named cache sharing.
- A dynamic lookup cannot share the cache if the named cache has duplicate rows.
- A named cache created by a dynamic Lookup transformation with a lookup policy of error on multiple match can be shared by a static or dynamic Lookup transformation with any lookup policy.
- A named cache created by a dynamic Lookup transformation with a lookup policy of use first, use last, or use all values can be shared by a Lookup transformation with the same lookup policy.
- Shared transformations must use the same output ports in the mapping. The criteria and result columns for the cache must match the cache files.
- A dynamic Lookup transformation cannot share the cache with another Lookup transformation within the same target load order group. In a target load order group, processing of caches takes place in parallel and completes after the target loads. The PowerCenter Integration Service does not allow cache sharing because the full cache is unavailable for subsequent Lookup transformations.

The Integration Service might use the memory cache, or it might build the memory cache from the file, depending on the type and location of the Lookup transformations.

The following table shows when you can share a named cache between a static Lookup transformation and a dynamic Lookup transformation:

Table 3. Location for Sharing Named Cache

Shared Cache	Location of Transformations	Cache Shared
Static with Static	<ul style="list-style-type: none"> - Same target load order group. - Separate target load order groups. - Separate mappings. 	<ul style="list-style-type: none"> - Integration Service uses memory cache. - Integration Service uses memory cache. - Integration Service builds memory cache from file.
Dynamic with Dynamic	<ul style="list-style-type: none"> - Separate target load order groups. - Separate mappings. 	<ul style="list-style-type: none"> - Integration Service uses memory cache. - Integration Service builds memory cache from file.
Dynamic with Static	<ul style="list-style-type: none"> - Separate target load order groups. - Separate mappings. 	<ul style="list-style-type: none"> - Integration Service builds memory cache from file. - Integration Service builds memory cache from file.

The following table describes the guidelines to follow when you configure Lookup transformations to share a named cache:

Table 4. Properties for Sharing Named Cache

Properties	Configuration for Named Shared Cache
Lookup SQL Override	If you use the Lookup SQL Override property, you must use the same override in all shared transformations.
Lookup Table Name	Must match.
Lookup Caching Enabled	Must be enabled.
Lookup Policy on Multiple Match	<ul style="list-style-type: none"> - A named cache created by a dynamic Lookup transformation with a lookup policy of error on multiple match can be shared by a static or dynamic Lookup transformation with any lookup policy. - A named cache created by a dynamic Lookup transformation with a lookup policy of use first or use last can be shared by a Lookup transformation with the same lookup policy. - A named cached can be shared by a dynamic Lookup transformation with a lookup policy of use all values if it shares the cache with another active lookup transformation with the same lookup policy.
Lookup Condition	Shared transformations must use the same ports in the lookup condition. The conditions can use different operators, but the ports must be the same.
Connection Information	The connection must be the same. When you configure the sessions, the database connection must match.
Source Type	Must match.
Tracing Level	-
Lookup Cache Directory Name	Must match.

Properties	Configuration for Named Shared Cache
Lookup Cache Persistent	Must be enabled.
Lookup Data Cache Size	When transformations within the same mapping share a cache, the Integration Service allocates memory for the first shared transformation in each pipeline stage. It does not allocate additional memory for subsequent shared transformations in the same pipeline stage.
Lookup Index Cache Size	When transformations within the same mapping share a cache, the Integration Service allocates memory for the first shared transformation in each pipeline stage. It does not allocate additional memory for subsequent shared transformations in the same pipeline stage.
Dynamic Lookup Cache	For more information about sharing static and dynamic caches, see "Guidelines for Sharing a Named Lookup Cache" on page 316 .
Output Old Value on Update	Does not need to match.
Update Dynamic Cache	Does not need to match.
Cache File Name Prefix	Must match. Enter the prefix only. Do not enter .idx or .dat. You cannot share a named cache with an unnamed cache.
Recache from Source	<p>If you configure a Lookup transformation to recache from source, subsequent Lookup transformations in the target load order group can share the existing cache whether or not you configure them to recache from source. If you configure subsequent Lookup transformations to recache from source, the Integration Service shares the cache instead of rebuilding the cache when it processes the subsequent Lookup transformation.</p> <p>If you do not configure the first Lookup transformation in a target load order group to recache from source, and you do configure the subsequent Lookup transformation to recache from source, the Integration Service does not rebuild the cache.</p>
Lookup/Output Ports	Lookup/output ports must be identical, but they do not need to be in the same order.
Insert Else Update	-
Update Else Insert	-
Thousand Separator	-
Decimal Separator	-
Case-Sensitive String Comparison	-
Null Ordering	-
Sorted Input	Must match.

Note: You cannot share a lookup cache created on a different operating system. For example, only an Integration Service on UNIX can read a lookup cache created on a Integration Service on UNIX, and only an Integration Service on Windows can read a lookup cache created on an Integration Service on Windows.

Tips for Lookup Caches

Cache small lookup tables.

Increase performance by caching small lookup tables.

Use a persistent lookup cache for static lookup tables.

If the lookup table does not change between sessions, configure the Lookup transformation to use a persistent lookup cache. The Integration Service saves and reuses cache files, eliminating the time required to read the lookup table.

CHAPTER 19

Dynamic Lookup Cache

This chapter includes the following topics:

- [Dynamic Lookup Cache Overview, 320](#)
- [Dynamic Lookup Properties, 321](#)
- [Lookup Transformation Values, 325](#)
- [Dynamic Lookup Cache Updates, 328](#)
- [Mappings with Dynamic Lookups, 330](#)
- [Conditional Dynamic Cache Updates, 332](#)
- [Dynamic Cache Update with Expression Results, 333](#)
- [Synchronizing Cache with the Lookup Source, 335](#)
- [Dynamic Lookup Cache Example, 336](#)
- [Rules and Guidelines for Dynamic Lookup Caches, 337](#)

Dynamic Lookup Cache Overview

Use a dynamic lookup cache to keep the cache synchronized with the target. You can use a dynamic cache with a relational lookup, flat file lookup, or a pipeline lookup.

The Integration Service builds the dynamic lookup cache when it processes the first lookup request. It queries the cache based on the lookup condition for each row that passes into the transformation. The Integration Service updates the lookup cache when it processes each row.

Based on the results of the lookup query, the row type, and the Lookup transformation properties, the Integration Service performs one of the following actions on the dynamic lookup cache when it reads a row from the source:

Inserts the row into the cache

The Integration Service inserts the row when the row is not in the cache and you configured the Lookup transformation to insert rows into the cache. You can configure the transformation to insert rows into the cache based on input ports or generated sequence IDs. The Integration Service flags the row as insert.

Updates the row in the cache

The Integration Service updates the row when the row exists in the cache and you configured the Lookup transformation to update rows in the cache. The Integration Service updates the row in the cache based on the input ports. The Integration Service flags the row as an update row.

Makes no change to the cache

The Integration Service makes no change when the row exists in the cache and you configured the Lookup transformation to insert new rows only. Or, the row is not in the cache and you specified to update existing rows only. Or, the row is in the cache, but based on the lookup condition, nothing changes. The Integration Service flags the row as unchanged.

Based on the value of the NewLookupRow, you can also configure a Router or Filter transformation with the dynamic Lookup transformation to route insert or update rows to the target table. You can route unchanged rows to another target table or flat file, or you can drop them.

The following figure shows a mapping with a Lookup transformation that uses a dynamic lookup cache:

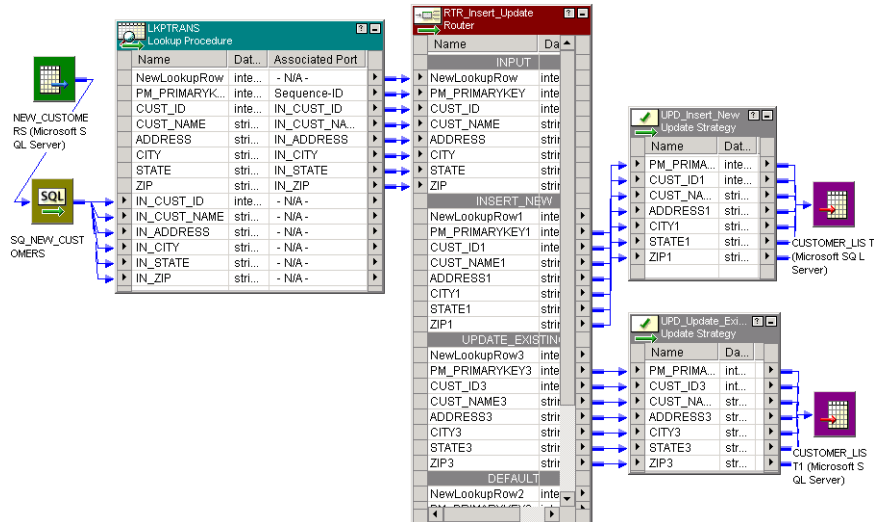

Dynamic Lookup Properties

A Lookup transformation with a dynamic cache has the following properties:

- **NewLookupRow.** The Designer adds this port to a Lookup transformation configured to use a dynamic cache. Indicates with a numeric value whether the Integration Service inserts or updates the row in the cache, or makes no change to the cache. To keep the lookup cache and the target table synchronized, pass rows to the target when the NewLookupRow value is equal to 1 or 2.
- **Associated Expression.** Associate lookup ports or the associated ports with an expression, an input/output port, or a sequence ID. The Integration Service uses the data in the associated expression to insert or update rows in the lookup cache. If you associate a sequence ID, the Integration Service generates a primary key for inserted rows in the lookup cache.
- **Ignore Null Inputs for Updates.** The Designer activates this port property for lookup/output ports when you configure the Lookup transformation to use a dynamic cache. Select this property when you do not want the Integration Service to update the column in the cache when the data in this column contains a null value.
- **Ignore in Comparison.** The Designer activates this port property for lookup/output ports not used in the lookup condition when you configure the Lookup transformation to use a dynamic cache. The Integration Service compares the values in all lookup ports with the values in their associated input ports by default. Select this property if you want the Integration Service to ignore the port when it compares values before updating a row.

- **Update Dynamic Cache Condition.** Allow the Integration Service to update the dynamic cache conditionally. You can create a boolean expression that determines whether to update the cache for an input row. Or, you can enable the Integration Service to update the cache with an expression result for an input row. The expression can contain values from the input row or the lookup cache.

NewLookupRows

When you configure a Lookup transformation to use a dynamic cache, the Designer adds the NewLookupRow port to the transformation. The Integration Service assigns a value to the port, depending on the action it performs to the lookup cache.

The following table lists the possible NewLookupRow values:

NewLookupRow Value	Description
0	Integration Service does not update or insert the row in the cache.
1	Integration Service inserts the row into the cache.
2	Integration Service updates the row in the cache.

When the Integration Service reads a row, it changes the lookup cache depending on the results of the lookup query and the Lookup transformation properties you define. It assigns the value 0, 1, or 2 to the NewLookupRow port to indicate if it inserts or updates the row in the cache, or makes no change.

The NewLookupRow value indicates how the Integration Service changes the lookup cache. It does not change the row type. Therefore, use a Filter or Router transformation and an Update Strategy transformation to keep the target table and lookup cache synchronized.

Configure the Filter transformation to pass new and updated rows to the Update Strategy transformation before passing them to the cached target. Use the Update Strategy transformation to change the row type of each row to insert or update, depending on the NewLookupRow value.

You can drop the rows that do not change the cache, or you can pass them to another target.

Define the filter condition in the Filter transformation based on the value of NewLookupRow. For example, use the following condition to pass both inserted and updated rows to the cached target:

```
NewLookupRow != 0
```

RELATED TOPICS:

- [“Configuring the Upstream Update Strategy Transformation” on page 330](#)

Associated Expression

When you configure a dynamic lookup cache, you must associate each lookup port with an input port, input/output port, a sequence ID, or an expression. When you choose an input/output port, the Designer associates the input/output port with the lookup/output port used in the lookup condition. When you configure an expression, the Integration Service updates the cache with the result of the associated expression. The expression can contain input values or values from the lookup cache.

To associate a lookup port with an input/output port, click the Associated Expression column for a lookup port. Select a port from the list.

To create an expression, click the Associated column for the lookup port. Choose Associated Expression from the list. The Expression Editor appears.

To create a generated key for a column in the target table, select *Sequence-ID* in the Associated Expression column. You can associate a generated key instead of an input port for lookup ports with the Bigint, Integer, or Small Integer datatype. For Bigint lookup ports, the generated key maximum value is 9,223,372,036,854,775,807. For Integer or Small Integer lookup ports, the generated key maximum value is 2,147,483,647.

When you select Sequence-ID in the Associated Expression column, the Integration Service generates a key when it inserts a row into the lookup cache.

The Integration Service uses the following process to generate sequence IDs:

1. When the Integration Service creates the dynamic lookup cache, it tracks the range of values for each port that has a sequence ID in the dynamic lookup cache.
2. When the Integration Service inserts a row of data into the cache, it generates a key for a port by incrementing the greatest sequence ID value by one.
3. When the Integration Service reaches the maximum number for a generated sequence ID, it starts over at one. The Integration Service increments each sequence ID by one until it reaches the smallest existing value minus one. If the Integration Service runs out of unique sequence ID numbers, the session fails.

The Integration Service generates a sequence ID for each row it inserts into the cache.

RELATED TOPICS:

- [“Dynamic Cache Update with Expression Results” on page 333](#)

Null Values

When you update a dynamic lookup cache and target table, the source data might contain some null values. The Integration Service can handle the null values in the following ways:

- **Insert null values.** The Integration Service uses null values from the source and updates the lookup cache and target table using all values from the source.
- **Ignore null values.** The Integration Service ignores the null values in the source and updates the lookup cache and target table using only the not null values from the source.

If you know the source data contains null values, and you do not want the Integration Service to update the lookup cache or target with null values, select the Ignore Null property for the corresponding lookup/output port.

For example, you want to update the master customer table. The source contains new customers and current customers whose last names have changed. The source contains the customer IDs and names of customers whose names have changed, but it contains null values for the address columns. You want to insert new customers and update the current customer names while retaining the current address information in a master customer table.

For example, the master customer table contains the following data:

Primary Key	CUST_ID	CUST_NAME	ADDRESS	CITY	STATE	ZIP
100001	80001	Marion James	100 Main St.	Mt. View	CA	94040
100002	80002	Laura Jones	510 Broadway Ave.	Raleigh	NC	27601
100003	80003	Shelley Lau	220 Burnside Ave.	Portland	OR	97210

The source contains the following data:

CUST_ID	CUST_NAME	ADDRESS	CITY	STATE	ZIP
80001	Marion Atkins	NULL	NULL	NULL	NULL
80002	Laura Gomez	NULL	NULL	NULL	NULL
99001	Jon Freeman	555 6th Ave.	San Jose	CA	95051

Select Insert Else Update in the Lookup transformation in the mapping. Select the Ignore Null option for all lookup/output ports in the Lookup transformation. When you run a session, the Integration Service ignores null values in the source data and updates the lookup cache and the target table with not null values:

PRIMARYKEY	CUST_ID	CUST_NAME	ADDRESS	CITY	STATE	ZIP
100001	80001	Marion Atkins	100 Main St.	Mt. View	CA	94040
100002	80002	Laura Gomez	510 Broadway Ave.	Raleigh	NC	27601
100003	80003	Shelley Lau	220 Burnside Ave.	Portland	OR	97210
100004	99001	Jon Freeman	555 6th Ave.	San Jose	CA	95051

Note: When you choose to ignore NULLs, you must verify that you output the same values to the target that the Integration Service writes to the lookup cache. When you choose to ignore NULLs, the lookup cache and the target table might become unsynchronized if you pass null input values to the target. Configure the mapping based on the value you want the Integration Service to output from the lookup/output ports when it updates a row in the cache:

- **New values.** Connect only lookup/output ports from the Lookup transformation to the target.
- **Old values.** Add an Expression transformation after the Lookup transformation and before the Filter or Router transformation. Add output ports in the Expression transformation for each port in the target table and create expressions to ensure you do not output null input values to the target.

Ignore Ports in Comparison

When you run a session that uses a dynamic lookup cache, the Integration Service compares the values in all lookup ports with the values in their associated input ports by default. It compares the values to determine whether or not to update the row in the lookup cache. When a value in an input port differs from the value in the lookup port, the Integration Service updates the row in the cache.

If you do not want to compare all ports, you can choose the ports you want the Integration Service to ignore when it compares ports. The Designer only enables this property for lookup/output ports when the port is not used in the lookup condition. You can improve performance by ignoring some ports during comparison.

You might want to do this when the source data includes a column that indicates whether or not the row contains data you need to update. Select the Ignore in Comparison property for all lookup ports except the port that indicates whether or not to update the row in the cache and target table.

You must configure the Lookup transformation to compare at least one port. The Integration Service fails the session when you ignore all ports.

To clear the Ignore in Comparison property, associate a port with the lookup port. When you clear the Ignore in Comparison property, the PowerCenter Integration Service updates the row in the cache.

SQL Override

When you add a WHERE clause in a Lookup transformation using a dynamic cache, connect a Filter transformation before the Lookup transformation to filter rows that you do not want to insert into the cache or target table. If you do not include the Filter transformation, you might get inconsistent results between the cache and the target table.

For example, you configure a Lookup transformation to perform a dynamic lookup on the employee table, EMP, matching rows by EMP_ID. You define the following lookup SQL override:

```
SELECT EMP_ID, EMP_STATUS FROM EMP ORDER BY EMP_ID, EMP_STATUS WHERE EMP_STATUS = 4
```

When you first run the session, the Integration Service builds the lookup cache from the target table based on the lookup SQL override. All rows in the cache match the condition in the WHERE clause, EMP_STATUS = 4.

For example, the Integration Service reads a source row that meets the lookup condition you specify, but the value of EMP_STATUS is 2. Although the target might have the row where EMP_STATUS is 2, the Integration Service does not find the row in the cache because of the SQL override. The Integration Service inserts the row into the cache and passes the row to the target table. When the Integration Service inserts this row in the target table, you might get inconsistent results when the row already exists. In addition, not all rows in the cache match the condition in the WHERE clause in the SQL override.

To verify that you only insert rows into the cache that match the WHERE clause, add a Filter transformation before the Lookup transformation and define the filter condition as the condition in the WHERE clause in the lookup SQL override.

For the example above, enter the following filter condition in the Filter transformation and the WHERE clause in the SQL override:

```
EMP_STATUS = 4
```

Lookup Transformation Values

The Lookup transformation contains values for input ports, the lookup, and output ports. If you enable a dynamic lookup cache, the output port values vary based on how you configure the dynamic lookup cache.

The Lookup transformation contains the following types of values:

Input value

Value that the Integration Service passes into the Lookup transformation.

Lookup value

Value that the Integration Service inserts into the cache.

Output value

Value that the Integration Service passes from the output port of the Lookup transformation. The output value of the lookup/output port depends on whether you choose to output old or new values when the Integration Service updates a row.

For example, the following Lookup transformation uses a dynamic lookup cache:

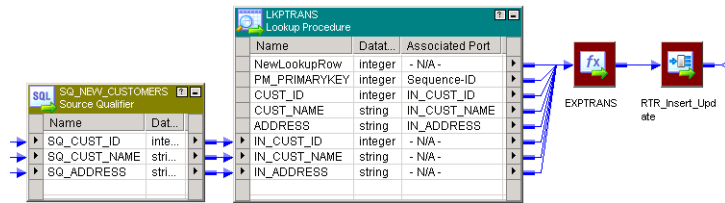

You define the following lookup condition:

```
IN_CUST_ID = CUST_ID
```

By default, the row type of all rows entering the Lookup transformation is insert. To perform both inserts and updates in the cache and target table, you select the **Insert Else Update** property in the Lookup transformation.

The following sections describe the values of the rows in the cache, the input rows, the lookup rows, and the output rows as you run the session.

Initial Cache Values

When you run the session, the Integration Service builds the lookup cache from the target table with the following data:

PK_PRIMARYKEY	CUST_ID	CUST_NAME	ADDRESS
100001	80001	Marion James	100 Main St.
100002	80002	Laura Jones	510 Broadway Ave.
100003	80003	Shelley Lau	220 Burnside Ave.

Input Values

The source contains rows that exist and rows that do not exist in the target table. The following rows pass into the Lookup transformation from the Source Qualifier transformation:

SQ_CUST_ID	SQ_CUST_NAME	SQ_ADDRESS
80001	Marion Atkins	100 Main St.
80002	Laura Gomez	510 Broadway Ave.
99001	Jon Freeman	555 6th Ave.

Lookup Values

The Integration Service looks up values in the cache based on the lookup condition. It updates rows in the cache for existing customer IDs 80001 and 80002. It inserts a row into the cache for customer ID 99001. The Integration Service generates a new key (PK_PRIMARYKEY) for the new row.

The following table shows the rows and values returned from the lookup:

PK_PRIMARYKEY	CUST_ID	CUST_NAME	ADDRESS
100001	80001	Marion Atkins	100 Main St.
100002	80002	Laura Gomez	510 Broadway Ave.
100004	99001	Jon Freeman	555 6th Ave.

Output Values

The Integration Service flags the rows in the Lookup transformation based on the inserts and updates it performs on the dynamic cache. These rows pass through an Expression transformation to a Router transformation that filters and passes on the inserted and updated rows to an Update Strategy transformation. The Update Strategy transformation flags the rows based on the value of the NewLookupRow port.

The output values of the lookup/output and input/output ports depend on whether you choose to output old or new values when the Integration Service updates a row. However, the output values of the NewLookupRow port and any lookup/output port that uses the sequence ID is the same for new and updated rows.

When you choose to output new values, the lookup/output ports output the following values:

NewLookupRow	PK_PRIMARYKEY	CUST_ID	CUST_NAME	ADDRESS
2	100001	80001	Marion Atkins	100 Main St.
2	100002	80002	Laura Gomez	510 Broadway Ave.
1	100004	99001	Jon Freeman	555 6th Ave.

When you choose to output old values, the lookup/output ports output the following values:

NewLookupRow	PK_PRIMARYKEY	CUST_ID	CUST_NAME	ADDRESS
2	100001	80001	Marion James	100 Main St.
2	100002	80002	Laura Jones	510 Broadway Ave.
1	100004	99001	Jon Freeman	555 6th Ave.

When the Integration Service updates rows in the lookup cache it uses the primary key (PK_PRIMARYKEY) values for rows in the cache and the target table.

The Integration Service uses the sequence ID to generate a primary key for the customer that it does not find in the cache. The Integration Service inserts the primary key value into the lookup cache and it returns the value to the lookup/output port.

The Integration Service output values from the input/output ports that match the input values.

Note: If the input value is NULL and you select the Ignore Null property for the associated input port, the input value does not equal the lookup value or the value out of the input/output port. When you select the Ignore Null property, the lookup cache and the target table might become unsynchronized if you pass null values to the target. You must verify that you do not pass null values to the target.

Dynamic Lookup Cache Updates

The Integration Service updates the dynamic cache based on the row type, query result, and the Lookup transformation properties.

When you use a dynamic lookup cache, define the row type of the rows entering the Lookup transformation as either insert or update. You can define some rows as insert and some as update, or all insert, or all update. By default, the row type of all rows entering a Lookup transformation is insert. You can add an Update Strategy transformation before the Lookup transformation to define the row type as update.

The Integration Service either inserts or updates rows in the cache, or does not change the cache. By default, the Lookup transformation inserts a row in the cache when the row type is insert, and updates a row when the row type is update.

However, you can configure the following Lookup properties to change how the Integration Service handles inserts and updates to the cache:

- **Insert Else Update.** Applies to rows entering the Lookup transformation where the row type is insert. Use this option to update the row in the cache if the data already exists in the cache. If you do not enable this option, the Integration Service inserts the rows into the cache regardless if they exist.
- **Update Else Insert.** Applies to rows entering the Lookup transformation where the row type is update. Use this option to insert an update row if the data does not exist in the cache. If you do not enable this option, the Integration Service ignores the row if it does not exist in the cache.

Note: You can select either the Insert Else Update or Update Else Insert property, or you can select both properties or neither property.

You can configure the Lookup transformation to synchronize the Lookup source and the dynamic cache. When you synchronize the Lookup source and the cache, the Lookup transformation inserts rows directly in the Lookup source. You do not pass insert rows to the target. Use this configuration to run multiple sessions with Lookup transformations that insert rows to the same target.

Insert Else Update

Use the Insert Else Update property to update existing rows in the dynamic lookup cache when the row type is insert.

This property only applies to rows entering the Lookup transformation where the row type is insert. When a row of any other row type, such as update, enters the Lookup transformation, the **Insert Else Update** property has no effect on how the Integration Service handles the row.

When you select **Insert Else Update** and the row type entering the Lookup transformation is insert, the Integration Service inserts the row into the cache if it is new. If the row exists in the index cache but the data cache is different than the current row, the Integration Service updates the row in the data cache.

If you do not select **Insert Else Update** and the row type entering the Lookup transformation is insert, the Integration Service inserts the row into the cache if it is new, and makes no change to the cache if the row exists.

The following table describes how the Integration Service changes the lookup cache when the row type of the rows entering the Lookup transformation is insert:

Insert Else Update Option	Row Found in Cache	Data Cache is Different	Lookup Cache Result	NewLookupRow Value
Cleared - insert only	Yes	-	No change	0
Cleared - insert only	No	-	Insert	1
Selected	Yes	Yes	Update	2 ¹
Selected	Yes	No	No change	0
Selected	No	-	Insert	1

¹ If you select **Ignore Null** for all lookup ports not in the lookup condition and if all those ports contain null values, the Integration Service does not change the cache and the NewLookupRow value equals 0.

Update Else Insert

Use the Update Else Insert property to insert new rows in the dynamic lookup cache when the row type is update.

You can select the **Update Else Insert** property in the Lookup transformation. This property only applies to rows entering the Lookup transformation where the row type is update. When a row of any other row type, such as insert, enters the Lookup transformation, this property has no effect on how the Integration Service handles the row.

When you select this property and the row type entering the Lookup transformation is update, the Integration Service updates the row in the cache if the row exists in the index cache and the cache data is different than the existing row. The Integration Service inserts the row in the cache if it is new.

If you do not select this property and the row type entering the Lookup transformation is update, the Integration Service updates the row in the cache if it exists, and makes no change to the cache if the row is new.

If you select **Ignore Null** for all lookup ports not in the lookup condition and if all those ports contain null values, the Integration Service does not change the cache and the NewLookupRow value equals 0.

The following table describes how the Integration Service changes the lookup cache when the row type of the rows entering the Lookup transformation is update:

Update Else Insert Option	Row Found in Cache	Data Cache is Different	Lookup Cache Result	NewLookupRow Value
Cleared (update only)	Yes	Yes	Update	2
Cleared (update only)	Yes	No	No change	0
Cleared (update only)	No	-	No change	0
Selected	Yes	Yes	Update	2

Update Else Insert Option	Row Found in Cache	Data Cache is Different	Lookup Cache Result	NewLookupRow Value
Selected	Yes	No	No change	0
Selected	No	-	Insert	1

Mappings with Dynamic Lookups

When you configure a mapping that contains a dynamic Lookup transformation, configure transformations upstream from the Lookup transformation to affect how the Lookup transformation updates dynamic cache. Configure transformations downstream from the Lookup transformation to ensure that the Integration Service updates rows marked for update and inserts rows marked for insert in the target.

Configuring the Upstream Update Strategy Transformation

You can configure an upstream Update Strategy transformation to change the row type of the rows that the Lookup transformation receives.

When you use a dynamic lookup cache, use Update Strategy transformations to define the row type for the following rows:

- **Rows entering the Lookup transformation.** By default, the row type of all rows entering a Lookup transformation is insert. However, use an Update Strategy transformation before a Lookup transformation to define rows as update, or some as update and some as insert.
- **Rows leaving the Lookup transformation.** The NewLookupRow value indicates how the Integration Service changed the lookup cache, but it does not change the row type. Use a Filter or Router transformation after the Lookup transformation to direct rows leaving the Lookup transformation based on the NewLookupRow value. Use Update Strategy transformations after the Filter or Router transformation to flag rows for insert or update before the target definition in the mapping.

Note: If you want to drop the unchanged rows, do not connect rows from the Filter or Router transformation to the target where the NewLookupRow equals 0.

When you define the row type as insert for rows entering a Lookup transformation, use the Insert Else Update property in the Lookup transformation. When you define the row type as update for rows entering a Lookup transformation, use the Update Else Insert property in the Lookup transformation. If you define some rows entering a Lookup transformation as update and some as insert, use either the Update Else Insert or Insert Else Update property, or use both properties.

The following figure shows a mapping with multiple Update Strategy transformations and a Lookup transformation using a dynamic cache:

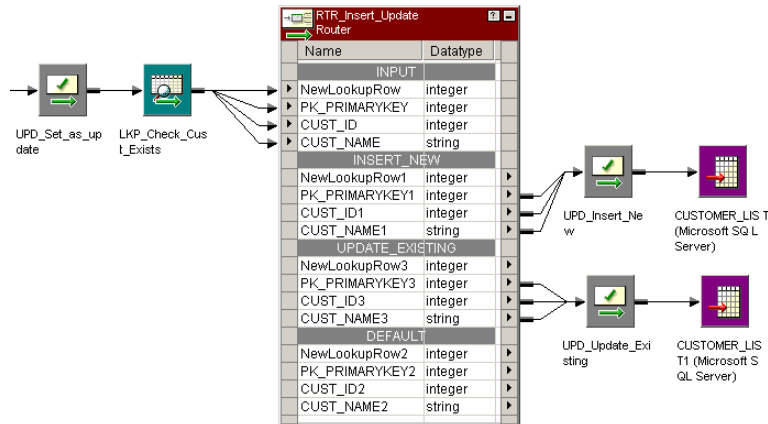

In this example, the Update Strategy transformation before the Lookup transformation flags all rows as update. Select the Update Else Insert property in the Lookup transformation. The Router transformation sends the inserted rows to the Insert_New Update Strategy transformation and sends the updated rows to the Update_Existing Update Strategy transformation. Output rows that are not connected to the target are dropped. The two Update Strategy transformations to the right of the Lookup transformation flag the rows as insert or update for the target.

Configuring Downstream Transformations

Configure downstream transformations to ensure that the dynamic lookup cache and target are synchronized.

When you use a dynamic lookup cache, the Integration Service writes to the lookup cache before it writes to the target table. The lookup cache and target table can become unsynchronized if the Integration Service does not write the data to the target. For example, the target database might reject the data.

Consider the following guidelines to keep the lookup cache synchronized with the lookup table:

- Use a Router transformation to pass rows to the cached target when the NewLookupRow value equals one or two.
- Use the Router transformation to drop rows when the NewLookupRow value equals zero. Or, output the rows to a different target.
- Use Update Strategy transformations after the Lookup transformation to flag rows for insert or update into the target.
- Set the error threshold to one when you run a session. When you set the error threshold to one, the session fails when it encounters the first error. The Integration Service does not write the new cache files to disk. Instead, it restores the original cache files, if they exist. You must also restore the pre-session target table to the target database.
- Verify that the Lookup transformation outputs the same values to the target that the Integration Service writes to the lookup cache. When you choose to output new values on update, only connect lookup/output ports to the target table instead of input/output ports. When you choose to output old values on update, add an Expression transformation after the Lookup transformation and before the Router transformation. Add output ports in the Expression transformation for each port in the target table and create expressions to ensure you do not output null input values to the target.
- Set the Treat Source Rows As property to Data Driven in the session properties.

- Select Insert and Update as Update when you define the update strategy target table options. This ensures that the Integration Service updates rows marked for update and inserts rows marked for insert. Select these options in the Transformations View on the Mapping tab in the session properties.

Null Values in Lookup Condition Columns

The Integration Service handles rows with null values in lookup condition columns differently, based on whether the row exists in the cache.

If the row does not exist in the lookup cache, the Integration Service inserts the row into the cache and passes it to the target table. If the row exists in the lookup cache, the Integration Service does not update the row in the cache or target table.

Note: If the source data contains null values in the lookup condition columns, set the error threshold to one. This ensures that the lookup cache and table remain synchronized if the Integration Service inserts a row in the cache, but the database rejects the row due to a Not Null constraint.

Configuring Sessions with a Dynamic Lookup Cache

When you configure a session with an Update Strategy transformation and a dynamic lookup cache, you must configure one of the following update strategy table options:

- Select Insert
- Select Update as Update
- Do not select Delete

The update strategy target table option ensures that the Integration Service updates rows marked for update and inserts rows marked for insert.

On the General Options settings on the Properties tab in the session properties, define the Treat Source Rows As option as Data Driven. If you do not choose Data Driven, the Integration Service flags all rows for the row type you specify in the Treat Source Rows As option and does not use the Update Strategy transformations in the mapping to flag the rows. The Integration Service does not insert and update the correct rows. If you do not choose Update as Update, the Integration Service does not correctly update the rows flagged for update in the target table. As a result, the lookup cache and target table might become unsynchronized.

Conditional Dynamic Cache Updates

You can update dynamic lookup cache based on the results of a boolean expression. The Integration Service updates the cache when the expression is true.

For example, you might have a product number, quantity on hand, and a timestamp column in a target table. You need to update the quantity on hand with the latest source values. You can update the quantity on hand when the source data has a timestamp greater than the timestamp in the dynamic cache. Create an expression in the Lookup transformation similar to the following expression:

```
lookup_timestamp < input_timestamp
```

The expression can include the lookup and the input ports. You can access built-in, mapping, and parameter variables. You can include user-defined functions and refer to unconnected transformations.

The expression returns true, false, or NULL. If the result of the expression is NULL, the expression is false. The Integration Service does not update the cache. You can add a check for NULL values in the expression if you need to change the expression result to true. The default expression value is true.

Create the expression with the Transformation Developer. You cannot override the **Dynamic Cache Update Condition** at the session level.

Session Processing

When you configure a conditional dynamic cache update, the Integration Service does not consider the conditional expression if the data does not exist. When you enable Insert Else Update, the Integration Service inserts a row in the cache if the data does not exist. If the data exists, it updates the cache when the conditional expression is true. When you enable Update Else Insert, the Integration Service updates the cache if the data exists in the cache and the conditional expression is true. When the data does not exist in the cache, the Integration Service inserts the row in the cache.

When the expression is true, the `NewLookupRow` value is one and the Integration Service updates the row. When the expression is false or NULL, the `NewLookupRow` value is zero. The Integration Service does not update the row.

If you configure the Lookup transformation to synchronize dynamic cache, the Integration Service inserts a row into the lookup source when it inserts a row into the cache.

Configuring a Conditional Dynamic Cache Lookup

You must enable the Lookup transformation to perform a conditional dynamic cache lookup before you can create a conditional expression.

Use the following steps to configure a conditional dynamic cache lookup:

1. Create a dynamic Lookup transformation in the Transformation Developer.
2. Click the Properties tab.
3. Enable Lookup Caching and Dynamic Lookup Cache properties.
4. To access the Expression Editor, click the Go button for the Update Dynamic Cache Condition property.
5. Define an expression condition. You can select input ports, lookup ports, and functions for the expression.
6. Click Validate to verify that the expression is valid.

If you do not validate an expression, the Designer validates it when you close the Expression Editor. If the expression is not valid, the Designer displays a warning.

Dynamic Cache Update with Expression Results

You can update the dynamic lookup cache values with the results of an expression.

For example, a product table target has a numeric column that contains an order count. Each time the Lookup transformation receives an order for the product, it updates the dynamic cache `order_count` with the results of the following expression:

```
order_count = order_count + 1
```

The Lookup transformation returns the `order_count`.

You can configure how the Integration Service handles the case where the expression evaluates to null.

Null Expression Values

The expression returns NULL if one of the values in the expression is null. However, you can configure an expression to return a non-null value.

If the expression refers to a lookup port, but the source data is new, the lookup port contains a default value. The default might be NULL. You can configure an IsNull expression to check for null values.

For example, the following expression checks if lookup_column is NULL:

```
iif (isnull(lookup_column), input_port, user_expression)
```

If the column is null, then return the input_port value. Otherwise return the value of the expression.

Session Processing

The Integration Service can insert and update rows in the dynamic lookup cache based on expression results. The expression results might vary based on whether the lookup port value is NULL and is included in the expression.

When you enable Insert Else Update, the Integration Service inserts a row with the expression result if the data is not in the cache. The lookup port value is NULL when data does not exist in the cache. If the expression refers to the lookup port value, the Integration Service substitutes the default port value in the expression. When you enable Insert Else Update and the data exists in the cache, the Integration Service updates the cache with the expression result.

When you enable Update Else Insert, the Integration Service updates the cache with the expression result if the data exists in the cache. When the data does not exist in the cache, the Integration Service inserts a row that contains the expression result. If the expression refers to a lookup port value, the Integration Service substitutes the default port value in the expression.

If you configure the Lookup transformation to synchronize dynamic cache, the Integration Service inserts a row into the lookup cache with the expression result. It inserts a row into the lookup source with the expression result.

Configuring an Expression for Dynamic Cache Updates

You must enable the Lookup transformation to perform dynamic lookups before you can create a conditional expression.

Use the following steps to configure an expression for dynamic cache lookup:

1. Create a dynamic Lookup transformation in the Transformation Developer.
2. Open the Properties tab.
3. Enable Lookup Caching and Dynamic Lookup Cache properties.
4. To create an expression, click the Associated Expression list for the lookup port you want to update.
5. Select Associated Expression.
The Expression Editor appears.
6. Define an expression by selecting input ports, lookup ports, and functions. The expression return value must match the lookup port type.
7. Click Validate to verify that the expression is valid.

If you do not validate an expression, the Designer validates it when you close the Expression Editor. If the expression is not valid, the Designer displays a warning.

Synchronizing Cache with the Lookup Source

A Lookup transformation maintains a dynamic lookup cache to track the rows that it passes to the target. When multiple sessions update the same target, you can configure the Lookup transformation in each session to synchronize the dynamic lookup cache to the same lookup source instead of a target.

When you configure a Lookup transformation to synchronize the cache with the Lookup source, the Lookup transformation performs a lookup on the Lookup source. If the data does not exist in the Lookup source, the Lookup transformation inserts the row into the Lookup source before it updates the dynamic lookup cache.

The data might exist in the Lookup source if another session inserted the row. To synchronize the lookup cache to the lookup source, the Integration Service retrieves the latest values from the Lookup source. The Lookup transformation inserts the values from the Lookup source in the dynamic lookup cache. The lookup source must be a relational table.

For example, you have multiple sessions running simultaneously. Each session generates product numbers for new product names. When a session generates a product number, the other sessions must use the same product number to identify the product. The product number is generated once and inserted in the lookup source. If another session processes a row containing the product, it must use the product number that is in the lookup source. Each session performs a lookup on the lookup source to determine which product numbers have already been generated.

The Integration Service performs the following tasks for insert rows:

- The Integration Service performs a lookup on the dynamic lookup cache. If data does not exist in the dynamic lookup cache, the Integration Service performs a lookup on the lookup source.
- If the data exists in the lookup source, the Integration Service retrieves the data from the lookup source. It inserts a row in the dynamic lookup cache with the columns from the lookup source. It does not update the cache with the source row.
- If the data is not in the lookup source, the Integration Service inserts the data into the lookup source and inserts the row into the cache.

The lookup source contains the same columns as the lookup cache. The Integration Service does not insert a column in the lookup cache unless the column is projected from the Lookup transformation or the column is part of a lookup condition.

NewLookupRow

When you synchronize dynamic cache with the lookup source, the Lookup transformation behavior does not change for update rows. When the Integration Service receives update rows, it updates the dynamic lookup cache and sets the value of NewLookupRow to 2. It does not update the lookup source. You can route the update rows through an Update Strategy transformation and pass the rows to the target.

When the Integration Service inserts rows into the lookup source, it sets NewLookupRow to 1. The Integration Service updates the dynamic lookup cache. When the transformation is configured to synchronize dynamic cache, and NewLookupRow is 1, you do not need to pass insert rows to the target.

When you configure the Insert Else Update property in the Lookup transformation, and the source row is an insert row, the Integration Service either inserts the row in the cache and the lookup source, or it updates the cache.

When you configure the Update Else Insert property in the Lookup transformation, and the source row is an update row, the Integration Service either updates the cache or it inserts the row into the cache and the lookup source.

Note: When different sessions process update rows for the same table, the processing order varies. You might get unexpected results.

Configuring Dynamic Cache Synchronization

When you create the Lookup transformation, you can configure it to synchronize the dynamic cache to the lookup source for insert rows.

To configure dynamic cache synchronization:

1. Open the Lookup transformation Properties tab.
2. Enable Dynamic Lookup Cache.
3. Enable Synchronize Dynamic Cache.

Dynamic Lookup Cache Example

Use a dynamic lookup cache when you need to insert and update rows in the target. When you use a dynamic lookup cache, you can insert and update the cache with the same data you pass to the target to insert and update.

For example, you need to update a table that contains customer data. The source data contains rows of customer data to insert or update in the target. Create a dynamic cache that represents the target. Configure a Lookup transformation to lookup customers in the cache.

The following figure shows a mapping that has a dynamic cache:

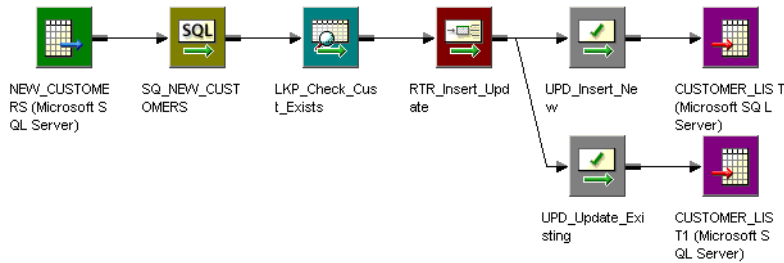

The Lookup transformation uses a dynamic lookup cache. When the session starts, the Integration Service builds the lookup cache from a Customer_List table. The Customer_List table is also the target in the mapping. When the Integration Service reads a row that is not in the lookup cache, it inserts the row in the cache.

The Lookup transformation returns the row to a Router transformation. The Router transformation directs the row to the UPD_Insert_New or the UPD_Update_Existing transformation. The Update Strategy transformations mark the row as insert or update before passing it to the target.

The Customer_List table changes as the session runs. The Integration Service inserts new rows and updates existing rows in the lookup cache. The Integration Service keeps the lookup cache and Customer_List table synchronized.

To generate keys for the target, use Sequence-ID in the associated port. The sequence ID generates primary keys for new rows the Integration Service inserts into the target table.

You increase session performance when you use a dynamic lookup cache because you build the cache from the database once. You can continue to use the lookup cache even though the data in the target table changes.

Rules and Guidelines for Dynamic Lookup Caches

Certain rules and guidelines apply when you use a dynamic lookup cache.

Consider the following guidelines when you use a dynamic lookup cache:

- You cannot share the cache between a dynamic Lookup transformation and static Lookup transformation in the same target load order group.
- You can enable a dynamic lookup cache for a relational, flat file, or Source Qualifier transformation lookup.
- The Lookup transformation must be a connected transformation.
- You can use a persistent or a non-persistent cache.
- If the dynamic cache is not persistent, the Integration Service always rebuilds the cache from the database, even if you do not enable **Recache from Lookup Source**.
- When you synchronize dynamic cache files with a lookup source table, the Lookup transformation inserts rows into the lookup source table and the dynamic lookup cache. If the source row is an update row, the Lookup transformation updates the dynamic lookup cache only.
- You can only create an equality lookup condition. You cannot look up a range of data in a dynamic cache.
- You must associate each lookup port that is not in the lookup condition with an input port, sequence ID, or associated expression.
- Use a Router transformation to pass rows to the cached target when the NewLookupRow value equals one or two.
- Use the Router transformation to drop rows when the NewLookupRow value equals zero. Or, you can output the rows to a different target.
- Verify that the Integration Service outputs the same values to the target that it writes to the lookup cache. When you choose to output new values on update, only connect lookup/output ports to the target table instead of the input/output ports. When you choose to output old values on update, add an Expression transformation after the Lookup transformation and before the Router transformation. Add output ports in the Expression transformation for each port in the target table and create expressions to ensure you do not output null input values to the target.
- When you use a lookup SQL override, map the correct columns to the appropriate targets for lookup.
- When you add a WHERE clause to the lookup SQL override, use a Filter transformation before the Lookup transformation. This ensures that the Integration Service inserts rows in the dynamic cache and target table that match the WHERE clause.
- When you configure a reusable Lookup transformation to use a dynamic cache, you cannot edit the condition or disable the **Dynamic Lookup Cache** property in a mapping.
- Use Update Strategy transformations after the Lookup transformation to flag the rows for insert or update for the target.
- Use an Update Strategy transformation before the Lookup transformation to define some or all rows as update if you want to use the Update Else Insert property in the Lookup transformation.
- Set the row type to Data Driven in the session properties.
- Select Insert and Update as Update for the target table options in the session properties.

CHAPTER 20

Normalizer Transformation

This chapter includes the following topics:

- [Normalizer Transformation Overview, 338](#)
- [Normalizer Transformation Components, 339](#)
- [Normalizer Transformation Generated Keys, 342](#)
- [VSAM Normalizer Transformation, 342](#)
- [Pipeline Normalizer Transformation, 347](#)
- [Using a Normalizer Transformation in a Mapping, 351](#)
- [Troubleshooting Normalizer Transformations, 354](#)

Normalizer Transformation Overview

The Normalizer transformation receives a row that contains multiple-occurring columns and returns a row for each instance of the multiple-occurring data. The transformation processes multiple-occurring columns or multiple-occurring groups of columns in each source row. The Normalizer transformation is an active transformation.

The Normalizer transformation parses multiple-occurring columns from COBOL sources, relational tables, or other sources. It can process multiple record types from a COBOL source that contains a REDEFINES clause.

For example, you might have a relational table that stores four quarters of sales by store. You need to create a row for each sales occurrence. You can configure a Normalizer transformation to return a separate row for each quarter.

The following source rows contain four quarters of sales by store:

```
Store1 100 300 500 700
Store2 250 450 650 850
```

The Normalizer returns a row for each store and sales combination. It also returns an index that identifies the quarter number:

```
Store1 100 1
Store1 300 2
Store1 500 3
Store1 700 4
Store2 250 1
Store2 450 2
Store2 650 3
Store2 850 4
```

The Normalizer transformation generates a key for each source row. The Integration Service increments the generated key sequence number each time it processes a source row. When the source row contains a

multiple-occurring column or a multiple-occurring group of columns, the Normalizer transformation returns a row for each occurrence. Each row contains the same generated key value.

When the Normalizer returns multiple rows from a source row, it returns duplicate data for single-occurring source columns. For example, Store1 and Store2 repeat for each instance of sales.

You can create a VSAM Normalizer transformation or a pipeline Normalizer transformation:

- **VSAM Normalizer transformation.** A non-reusable transformation that is a Source Qualifier transformation for a COBOL source. The Mapping Designer creates VSAM Normalizer columns from a COBOL source in a mapping. The column attributes are read-only. The VSAM Normalizer receives a multiple-occurring source column through one input port.
- **Pipeline Normalizer transformation.** A transformation that processes multiple-occurring data from relational tables or flat files. You create the columns manually and edit them in the Transformation Developer or Mapping Designer. The pipeline Normalizer transformation represents multiple-occurring columns with one input port for each source column occurrence.

Normalizer Transformation Components

A Normalizer transformation contains the following tabs:

- **Transformation.** Enter the name and description of the transformation. The naming convention for an Normalizer transformation is *NRM_TransformationName*. You can also make the pipeline Normalizer transformation reusable.
- **Ports.** View the transformation ports and attributes.
- **Properties.** Configure the tracing level to determine the amount of transaction detail reported in the session log file. Choose to reset or restart the generated key sequence value in the next session.
- **Normalizer.** Define the structure of the source data. The Normalizer tab defines source data as columns and groups of columns.
- **Metadata Extensions.** Configure the extension name, datatype, precision, and value. You can also create reusable metadata extensions.

Ports Tab

When you define a Normalizer transformation, you configure the columns in the Normalizer tab. The Designer creates the ports. You can view the Normalizer ports and attributes on the Ports tab.

Pipeline and VSAM Normalizer transformations represent multiple-occurring source columns differently. A VSAM Normalizer transformation has one input port for a multiple-occurring column. A pipeline Normalizer transformation has multiple input ports for a multiple-occurring column.

The Normalizer transformation has one output port for each single-occurring input port. When a source column is multiple-occurring, the pipeline and VSAM Normalizer transformations have one output port for the column. The transformation returns a row for each source column occurrence.

The Normalizer transformation has a generated column ID (GCID) port for each multiple-occurring column. The generated column ID is an index for the instance of the multiple-occurring data. For example, if a column occurs four times in a source record, the Normalizer returns a value of 1, 2, 3, or 4 in the generated column ID based on which instance of the multiple-occurring data occurs in the row.

The naming convention for the Normalizer generated column ID is *GCID_<occurring_field_name>*.

The Normalizer transformation has at least one generated key port. The Integration Service increments the generated key sequence number each time it processes a source row.

The following figure shows the Normalizer transformation Ports tab:

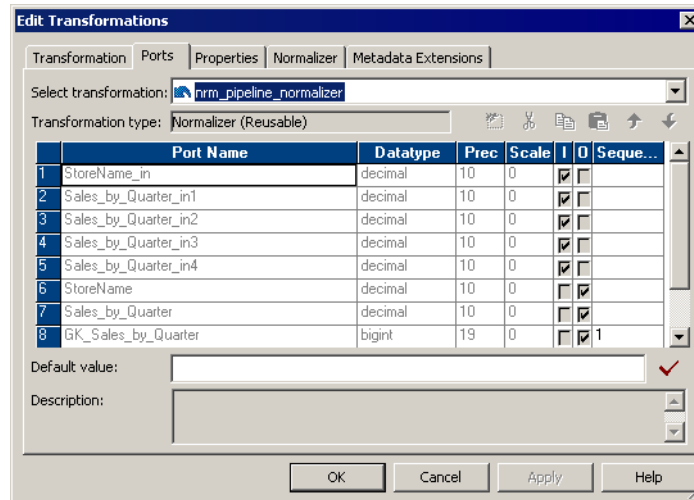

In this example, Sales_By_Quarter is multiple-occurring in the source. The Normalizer transformation has one output port for Sales_By_Quarter. It returns four rows for each source row. Generated key start value is 1.

You can change the ports on a pipeline Normalizer transformation by editing the columns on the Normalizer tab. To change a VSAM Normalizer transformation, you need to change the COBOL source and recreate the transformation.

Properties Tab

Configure the Normalizer transformation general properties on the Properties tab.

You can configure the following Normalizer transformation properties:

Property	Required/Optional	Description
Reset	Required	At the end of a session, resets the value sequence for each generated key value to the value it was before the session.
Restart	Required	Starts the generated key sequence at 1. Each time you run a session, the key sequence value starts at 1 and overrides the sequence value on the Ports tab.
Tracing Level	Required	Sets the amount of detail included in the session log when you run a session containing this transformation.

Normalizer Tab

The Normalizer tab defines the structure of the source data. The Normalizer tab defines source data as columns and groups of columns. A group of columns might define a record in a COBOL source or it might define a group of multiple-occurring fields in the source.

The column level number identifies groups of columns in the data. Level numbers define a data hierarchy. Columns in a group have the same level number and display sequentially below a group-level column. A group-level column has a lower level number, and it contains no data.

The following figure shows the Normalizer tab of a pipeline Normalizer transformation:

Figure 3. Normalizer Tab

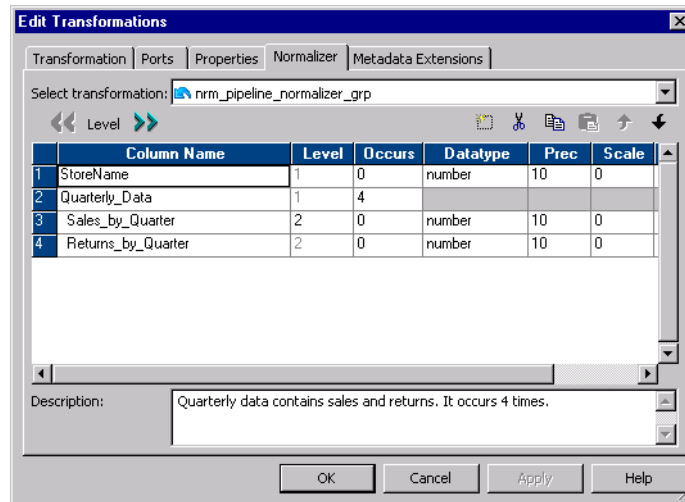

Quarterly_Data is a group-level column. It is Level 1. The Quarterly_Data group occurs four times in each row. Sales_by_Quarter and Returns_by_Quarter are Level 2 columns and belong to the group.

Each column has an Occurs attribute. The Occurs attribute identifies columns or groups of columns that occur more than once in a source row.

When you create a pipeline Normalizer transformation, you can edit the columns. When you create a VSAM Normalizer transformation, the Normalizer tab is read-only.

The following table describes the Normalizer tab attributes that are common to the VSAM and pipeline Normalizer transformations:

Attribute	Description
Column Name	Name of the source column.
Level	Group columns. Columns in the same group occur beneath a column with a lower level number. When each column is the same level, the transformation contains no column groups.
Occurs	The number of instances of a column or group of columns in the source row.
Datatype	The transformation column datatype can be String, Nstring, or Number.
Prec	Precision. Length of the column.
Scale	Number of decimal positions for a numeric column.

The Normalizer tab for a VSAM Normalizer transformation contains the same attributes as the pipeline Normalizer transformation, but it includes attributes unique to a COBOL source definition.

Normalizer Transformation Generated Keys

The Normalizer transformation returns at least one generated key column in the output row. The Integration Service increments the generated key sequence number each time it processes a source row. The Integration Service determines the initial key value from the generated key value in the Ports tab of the Normalizer transformation. When you create a Normalizer transformation, the generated key value is 1 by default. The naming convention for the Normalizer generated key is `GK_<redefined_field_name>`.

RELATED TOPICS:

- [“Generating Key Values” on page 353](#)

Storing Generated Key Values

You can view the current generated key values on the Normalizer transformation Ports tab. At the end of each session, the Integration Service updates the generated key value in the Normalizer transformation to the last value generated for the session plus one. The maximum generated key value is 9,223,372,036,854,775,807. If you have multiple instances of the Normalizer transformation in the repository, the Integration Service updates the generated key value in all versions when it runs a session.

Note: You cannot change the current generated key values on the Normalizer transformation Ports tab.

Changing the Generated Key Values

You can change the generated key value in the following ways:

- **Reset the generated key sequence.** Reset the generated key sequence on the Normalizer transformation Properties tab. When you reset the generated key sequence, the Integration Service resets the generated key start value back to the value it was before the session. Reset the generated key sequence when want to create the same generated key values each time you run the session.
- **Restart the generated key sequence.** Restart the generated key sequence on the Normalizer transformation Properties tab. When you restart the generated key sequence, the Integration Service starts the generated key sequence at 1 the next time it runs a session. When you restart the generated key sequence, the generated key start value does not change in the Normalizer transformation until you run a session. When you run the session, the Integration Service overrides the sequence number value on the Ports tab.

When you reset or restart the generated key sequence, the reset or restart affects the generated key sequence values the next time you run a session. You do not change the current generated key sequence values in the Normalizer transformation. When you reset or restart the generated key sequence, the option is enabled for every session until you disable the option.

VSAM Normalizer Transformation

The VSAM Normalizer transformation is the source qualifier for a COBOL source definition. A COBOL source is a flat file that can contain multiple-occurring data and multiple types of records in the same file.

VSAM (Virtual Storage Access Method) is a file access method for an IBM mainframe operating system. VSAM files organize records in indexed or sequential flat files. However, you can use the VSAM Normalizer transformation for any flat file source that you define with a COBOL source definition.

A COBOL source definition can have an OCCURS statement that defines a multiple-occurring column. The COBOL source definition can also contain a REDEFINES statement to define more than one type of record in the file.

The following COBOL copybook defines a sales record:

```

01 SALES_RECORD.
  03 HDR_DATA.
    05 HDR_REC_TYPE          PIC X.
    05 HDR_STORE             PIC X(02).
  03 STORE_DATA.
    05 STORE_NAME            PIC X(30).
    05 STORE_ADDR1           PIC X(30).
    05 STORE_CITY            PIC X(30).
  03 DETAIL_DATA REDEFINES STORE_DATA.
    05 DETAIL_ITEM           PIC 9(9).
    05 DETAIL_DESC           PIC X(30).
    05 DETAIL_PRICE          PIC 9(4)V99.
    05 DETAIL_QTY            PIC 9(5).
    05 SUPPLIER_INFO OCCURS 4 TIMES.
      10 SUPPLIER_CODE        PIC XX.
      10 SUPPLIER_NAME        PIC X(8).

```

The sales file can contain two types of sales records. Store_Data defines a store and Detail_Data defines merchandise sold in the store. The REDEFINES clause indicates that Detail_Data fields might occur in a record instead of Store_Data fields.

The first three characters of each sales record is the header. The header includes a record type and a store ID. The value of Hdr_Rec_Type defines whether the rest of the record contains store information or merchandise information. For example, when Hdr_Rec_Type is "S," the record contains store data. When Hdr_Rec_Type is "D," the record contains detail data.

When the record contains detail data, it includes the Supplier_Info fields. The OCCURS clause defines four suppliers in each Detail_Data record.

The following figure shows the Sales_File COBOL source definition that you might create from the COBOL copybook:

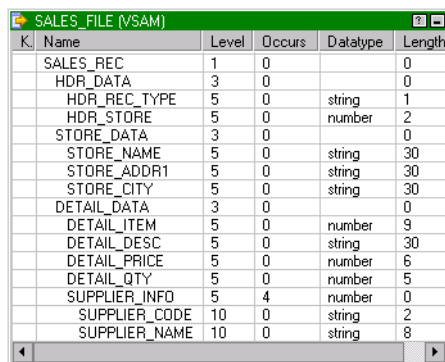

K	Name	Level	Occurs	Datatype	Length
	SALES_REC	1	0		0
	HDR_DATA	3	0		0
	HDR_REC_TYPE	5	0	string	1
	HDR_STORE	5	0	number	2
	STORE_DATA	3	0		0
	STORE_NAME	5	0	string	30
	STORE_ADDR1	5	0	string	30
	STORE_CITY	5	0	string	30
	DETAIL_DATA	3	0		0
	DETAIL_ITEM	5	0	number	9
	DETAIL_DESC	5	0	string	30
	DETAIL_PRICE	5	0	number	6
	DETAIL_QTY	5	0	number	5
	SUPPLIER_INFO	5	4	number	0
	SUPPLIER_CODE	10	0	string	2
	SUPPLIER_NAME	10	0	string	8

The Sales_Rec, Hdr_Data, Store_Data, Detail_Data, and Supplier_Info columns are group-level columns that identify groups of lower level data. Group-level columns have a length of zero because they contain no data. None of these columns are output ports in the source definition.

The Supplier_Info group contains Supplier_Code and Supplier_Name columns. The Supplier_Info group occurs four times in each Detail_Data record.

When you create a VSAM Normalizer transformation from the COBOL source definition, the Mapping Designer creates the input/output ports in the Normalizer transformation based on the COBOL source definition. The Normalizer transformation contains at least one generated key output port. When the COBOL

source has multiple-occurring columns, the Normalizer transformation has a generated column ID output port.

The following figure shows the Normalizer transformation ports the Mapping Designer creates from the source definition:

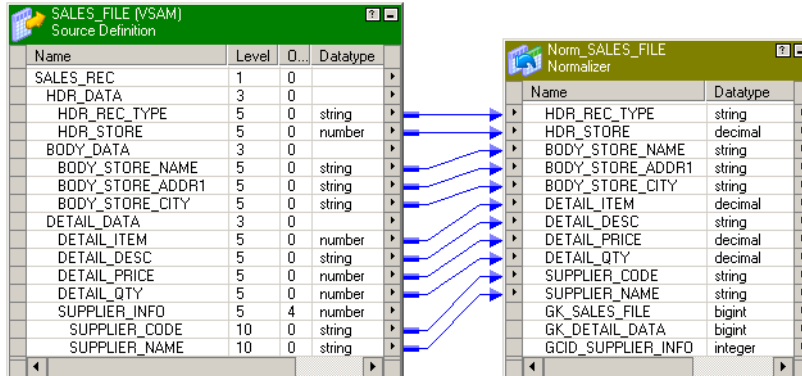

The Supplier_Info group of columns occurs four times in each COBOL source row.

The COBOL source row might contain the following data:

```
Item1 ItemDesc 100 25 A Supplier1 B Supplier2 C Supplier3 D Supplier4
```

The Normalizer transformation returns a row for each occurrence of the Supplier_Code and Supplier_Name columns. Each output row contains the same item, description, price, and quantity values.

The Normalizer returns the following detail data rows from the COBOL source row:

```
Item1 ItemDesc 100 25 A Supplier1 1 1
Item1 ItemDesc 100 25 B Supplier2 1 2
Item1 ItemDesc 100 25 C Supplier3 1 3
Item1 ItemDesc 100 25 D Supplier4 1 4
```

Each output row contains a generated key and a column ID. The Integration Service updates the generated key value when it processes a new source row. In the detail data rows, the generated key value is 1.

The column ID defines the Supplier_Info column occurrence number. The Integration Service updates the column ID for each occurrence of the Supplier_Info. The column ID values are 1, 2, 3, 4 in the detail data rows.

VSAM Normalizer Ports Tab

The VSAM Normalizer Ports tab shows the transformation input and output ports. It has one input/output port for each COBOL source column. It has one input/output port for a multiple-occurring column. The transformation does not have input or output ports for group level columns.

The following figure shows the VSAM Normalizer Ports tab:

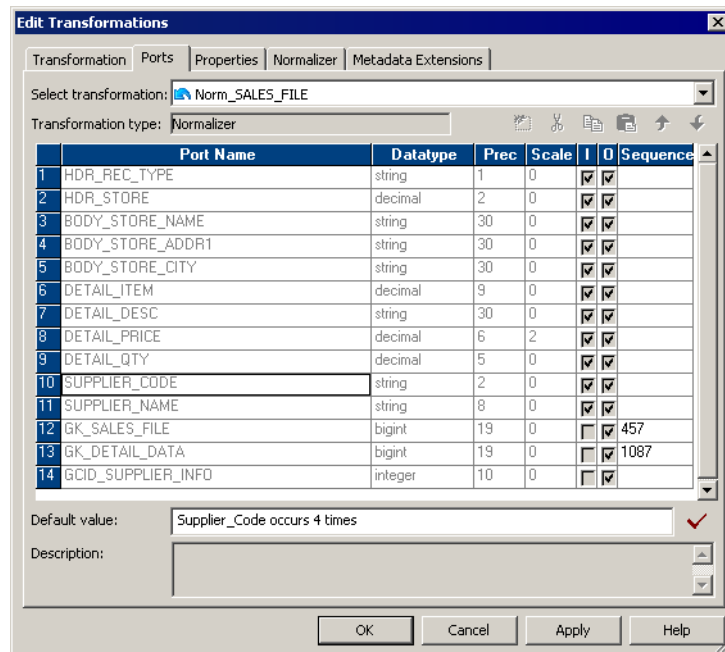

In this example, Supplier_Code and Supplier_Name occur four times in the COBOL source. The Ports tab shows one Supplier_Code port and one Supplier_Name port. The generated key start values are 457 and 1087.

VSAM Normalizer Tab

When you create a VSAM Normalizer transformation, the Mapping Designer creates the columns from a COBOL source. The Normalizer tab displays the same information as the COBOL source definition. You cannot edit the columns on a VSAM Normalizer tab.

The following table describes attributes on the VSAM Normalizer tab:

Attribute	Description
POffs	Physical offset. Location of the field in the file. The first byte in the file is zero.
Plen	Physical length. Number of bytes in the field.
Column Name	Name of the source field.
Level	Provides column group hierarchy. The higher the level number, the lower the data is in the hierarchy. Columns in the same group occur beneath a column with a lower level number. When each column is the same level, the transformation contains no column groups.
Occurs	The number of instances of a column or group of columns in the source row.
Datatype	The transformation datatype can be String, Nstring, or Number.
Prec	Precision. Length of the column.
Scale	Number of decimal positions for a numeric column.

Attribute	Description
Picture	How the data is stored or displayed in the source. Picture 99V99 defines a numeric field with two implied decimals. Picture X(10) indicates ten characters.
Usage	COBOL data storage format such as COMP, BINARY, and COMP-3. When the Usage is DISPLAY, the Picture clause defines how the source data is formatted when you view it.
Key Type	Type of key constraint to apply to the field for a VSAM file. Choose one of the following key types: <ul style="list-style-type: none"> - Not a Key. The field is not an index in a VSAM file. - Primary Key. The field is the primary index in the VSAM file. The field contains unique values. - Alternate Key. The field is a secondary index in the VSAM file. The field contains unique values. - Primary Duplicate Key. The field is the primary index in the VSAM file. The field can contain duplicate values. - Alternate Duplicate Key. The field is a secondary index in the VSAM file. The field can contain duplicate values.
Signed (S)	Indicates whether numeric values are signed.
Trailing Sign (T)	Indicates that the sign (+ or -) exists in the last digit of the field. If not enabled, the sign appears as the first character in the field.
Included Sign (I)	Indicates whether the sign is included in any value appearing in the field.
Real Decimal Point (R)	Indicates whether the decimal point is a period (.) or the decimal point is represented by the V character in a numeric field.
Redefines	Indicates that the column REDEFINES another column.
Business Name	Descriptive name that you give to a column.

Steps to Create a VSAM Normalizer Transformation

When you create a VSAM Normalizer transformation, you drag a COBOL source into a mapping and the Mapping Designer creates the transformation columns from the source. The Normalizer transformation is the source qualifier for the COBOL source in the mapping.

When you add a COBOL source to a mapping, the Mapping Designer creates and configures a Normalizer transformation. The Mapping Designer identifies nested records and multiple-occurring fields in the COBOL source. It creates the columns and ports in the Normalizer transformation from the source columns.

To create a VSAM Normalizer transformation:

1. In the Mapping Designer, create a new mapping or open an existing mapping.
2. Drag a COBOL source definition into the mapping.

The Designer adds a Normalizer transformation and connects it to the COBOL source definition. If you have not enabled the option to create a source qualifier by default, the Create Normalizer Transformation dialog box appears.

3. If the Create Normalizer Transformation dialog box appears, you can choose from the following options:
 - **VSAM Source.** Create a transformation from the COBOL source definition in the mapping.

- **Pipeline.** Create a transformation, but do not define columns from a COBOL source. Define the columns manually on the Normalizer tab. You might choose this option when you want to process multiple-occurring data from another transformation in the mapping.

To create the VSAM Normalizer transformation, select the VSAM Normalizer transformation option. The dialog box displays the name of the COBOL source definition in the mapping. Select the COBOL source definition and click OK.

4. Open the Normalizer transformation.

5. Select the Ports tab to view the ports in the Normalizer transformation.

The Designer creates the ports from the COBOL source definition by default.

6. Click the Normalizer tab to review the source column organization.

The Normalizer tab contains the same information as the Columns tab of the COBOL source. However, you cannot modify column attributes in the Normalizer transformation. To change column attributes, change the COBOL copybook, import the COBOL source, and recreate the Normalizer transformation.

7. Select the Properties tab to set the tracing level.

You can also configure the transformation to reset the generated key sequence numbers at the start of the next session.

Pipeline Normalizer Transformation

When you create a Normalizer transformation in the Transformation Developer, you create a pipeline Normalizer transformation by default. When you create a pipeline Normalizer transformation, you define the columns based on the data the transformation receives from a another type of transformation such as a Source Qualifier transformation. The Designer creates the input and output Normalizer transformation ports from the columns you define.

The following figure shows the Normalizer transformation columns for a transformation that receives four sales columns in each relational source row:

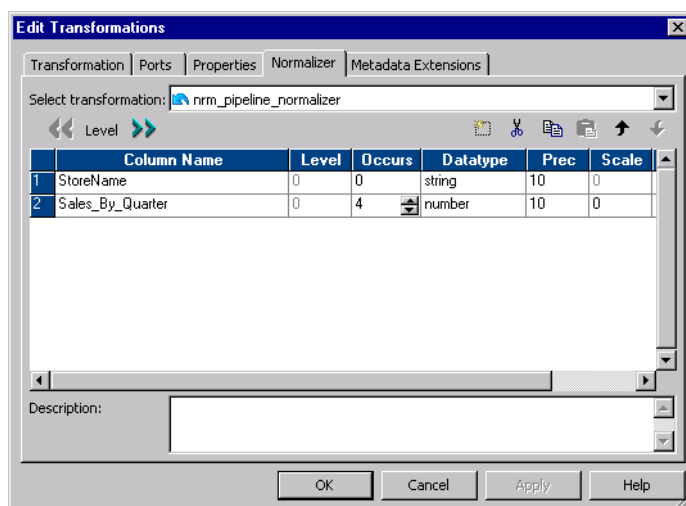

Each source row has a StoreName column and four instances of Sales_By_Quarter.

The source rows might contain the following data:

```
Dellmark 100 450 650 780
Tonys    666 333 444 555
```

The pipeline Normalizer transformation has an input port for each instance of a multiple-occurring column.

The following figure shows the ports that the Designer creates from the columns in the Normalizer transformation:

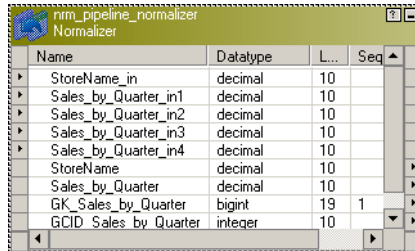

The screenshot shows a window titled 'nrm_pipeline_normalizer Normalizer'. It contains a table with the following columns: Name, Datatype, L..., and Seq. The table lists the following ports:

Name	Datatype	L...	Seq
StoreName_in	decimal	10	
Sales_by_Quarter_in1	decimal	10	
Sales_by_Quarter_in2	decimal	10	
Sales_by_Quarter_in3	decimal	10	
Sales_by_Quarter_in4	decimal	10	
StoreName	decimal	10	
Sales_by_Quarter	decimal	10	
GK_Sales_by_Quarter	bigint	19	1
GCID_Sales_by_Quarter	integer	10	

The Normalizer transformation returns one row for each instance of the multiple-occurring column:

```
Dellmark 100 1 1
Dellmark 450 1 2
Dellmark 650 1 3
Dellmark 780 1 4
Tonys    666 2 1
Tonys    333 2 2
Tonys    444 2 3
Tonys    555 2 4
```

The Integration Service increments the generated key sequence number each time it processes a source row. The generated key links each quarter sales to the same store. In this example, the generated key for the Dellmark row is 1. The generated key for the Tonys store is 2.

The transformation returns a generated column ID (GCID) for each instance of a multiple-occurring field. The GCID_Sales_by_Quarter value is always 1, 2, 3, or 4 in this example.

Pipeline Normalizer Ports Tab

The pipeline Normalizer Ports tab displays the input and output ports for the transformation. It has one input/output port for each single-occurring column you define in the transformation. It has one port for each occurrence of a multiple-occurring column. The transformation does not have input or output ports for group level columns.

The following figure shows the pipeline Normalizer transformation Ports tab:

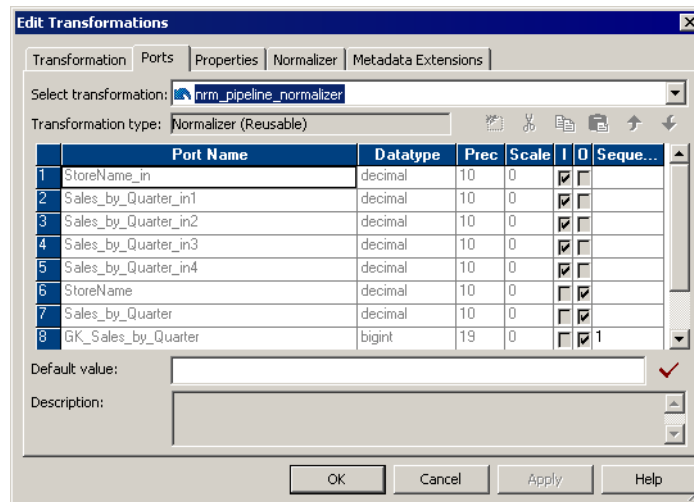

The Designer creates an input port for each occurrence of a multiple-occurring column.

To change the ports in a pipeline Normalizer transformation, modify the columns in the Normalizer tab. When you add a column occurrence, the Designer adds an input port. The Designer creates ports for the lowest level columns. It does not create ports for group level columns.

Pipeline Normalizer Tab

When you create a pipeline Normalizer transformation, you define the columns on the Normalizer tab. The Designer creates input and output ports based on the columns you enter on the Normalizer tab.

The following table describes the pipeline Normalizer tab attributes:

Attribute	Description
Column Name	Name of the column.
Level	Identifies groups of columns. Columns in the same group have the same level number. Default is zero. When each column is the same level, the transformation contains no column groups.
Occurs	The number of instances of a column or group of columns in the source row.
Datatype	The column datatype can be String, Nstring, or Number.
Prec	Precision. Length of the column.
Scale	Number of decimal digits in a numeric value.

Normalizer Tab Column Groups

When a source row contains groups of repeating columns, you can define column groups on the Normalizer tab. The Normalizer transformation returns a row for each column group occurrence instead for each column occurrence.

The level number on the Normalizer tab identifies a hierarchy of columns. Group level columns identify groups of columns. The group level column has a lower level number than columns in the group. Columns in

the same group have the same level number and display sequentially below the group level column on the Normalizer tab.

The following figure shows a group of multiple-occurring columns in the Normalizer tab:

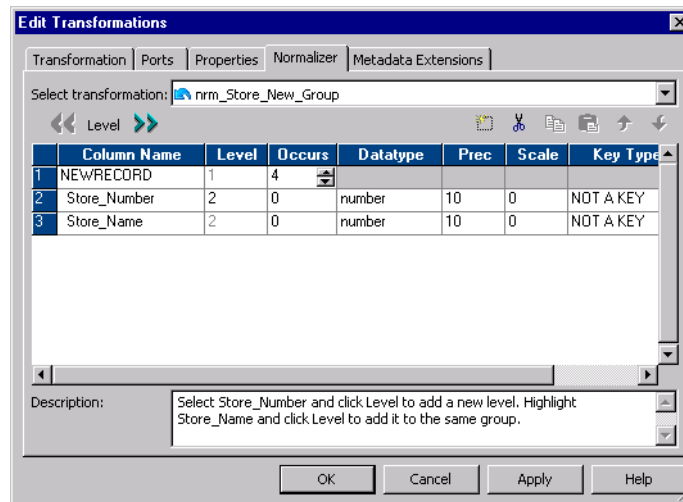

In this example, the NEWRECORD column contains no data. It is a Level 1 group column. The group occurs four times in each source row. Store_Number and Store_Name are Level 2 columns. They belong to the NEWRECORD group.

Steps to Create a Pipeline Normalizer Transformation

When you create a pipeline Normalizer transformation, you define the columns on the Normalizer tab.

You can create a Normalizer transformation in the Transformation Developer or in the Mapping Designer.

To create a Normalizer transformation:

1. In the Transformation Developer or the Mapping Designer, click Transformation > Create. Select Normalizer transformation. Enter a name for the Normalizer transformation.

The naming convention for Normalizer transformations is *NRM_TransformationName*.

2. Click Create and click Done.
3. Open the Normalizer transformation and click the Normalizer tab.
4. Click Add to add a new column.

The Designer creates a new column with default attributes. You can change the name, datatype, precision, and scale.

5. To create a multiple-occurring column, enter the number of occurrences in the Occurs column.
6. To create a group of multiple-occurring columns, enter at least one of the columns on the Normalizer tab. Select the column. Click Level.

The Designer adds a NEWRECORD group level column above the selected column. NEWRECORD becomes Level 1. The selected column becomes Level 2. You can rename the NEWRECORD column.

All columns are the same level by default. The Level defines columns that are grouped together.

7. You can change the column level for other columns to add them to the same group. Select a column and click Level to change it to the same level as the column above it.

Columns in the same group must appear sequentially in the Normalizer tab.

8. Change the occurrence at the group level to make the group of columns multiple-occurring.
9. Click Apply to save the columns and create input and output ports.
The Designer creates the Normalizer transformation input and output ports. In addition, the Designer creates the generated key columns and a column ID for each multiple-occurring column or group of columns.
10. Select the Properties tab to change the tracing level or reset the generated key sequence numbers after the next session.

Using a Normalizer Transformation in a Mapping

When a Normalizer transformation receives more than one type of data from a COBOL source, you need to connect the Normalizer output ports to different targets based on the type of data in each row. The following example describes how to map the Sales_File COBOL source definition through a Normalizer transformation to multiple targets.

The Sales_File source record contains either store information or information about items that a store sells. The sales file contains both types of records.

The following example includes two sales file records:

Record Type	Data
Store Record	H01Software Suppliers Incorporated 1111 Battery Street San Francisco
Item Record	D01123456789USB Line - 10 Feet 001495000020 01Supp1 02Supp2 03Supp3 04Supp4

The COBOL source definition and the Normalizer transformation have columns that represent fields in both types of records. You need to filter the store rows from the item rows and pass them to different targets.

The following figure shows the Sales_File COBOL source with its corresponding Store_Data (which has a value of "S") and Detail_Data (which has a value of "D"):

K	Name	Level	Occurs	Datatype	Length
	SALES_REC	1	0		0
	HDR_DATA	3	0		0
	HDR_REC_TYPE	5	0	string	1
	HDR_STORE	5	0	number	2
	STORE_DATA	3	0		0
	STORE_NAME	5	0	string	30
	STORE_ADDR1	5	0	string	30
	STORE_CITY	5	0	string	30
	DETAIL_DATA	3	0		0
	DETAIL_ITEM	5	0	number	9
	DETAIL_DESC	5	0	string	30
	DETAIL_PRICE	5	0	number	6
	DETAIL_QTY	5	0	number	5
	SUPPLIER_INFO	5	4	number	0
	SUPPLIER_CODE	10	0	string	2
	SUPPLIER_NAME	10	0	string	8

The Hdr_Rec_Type defines whether the record contains store or merchandise data. When the Hdr_Rec_Type value is "S," the record contains Store_Data. When the Hdr_Rec_Type is "D," the record contains Detail_Data. Detail_Data always includes four occurrences of Supplier_Info fields.

To filter data, connect the Normalizer output rows to a Router transformation to route the store, item, and supplier data to different targets. You can filter rows in the Router transformation based on the value of Hdr_Rec_Type.

The following figure shows the mapping that routes Sales_File records to different targets:

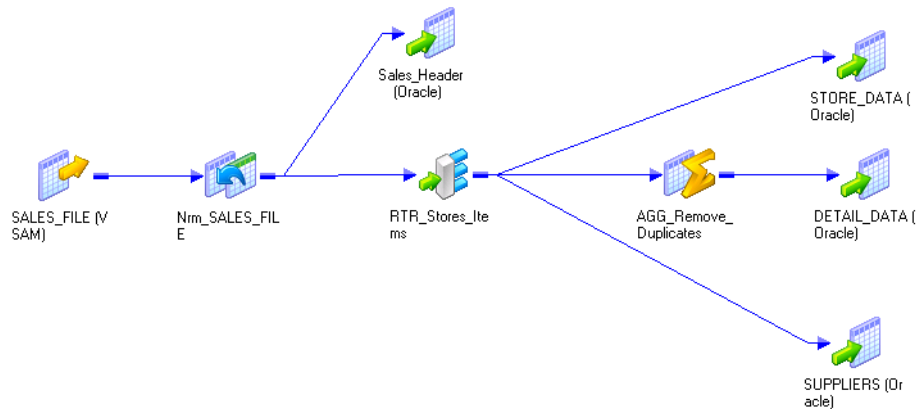

The mapping filters multiple record types from the COBOL source to relational targets. The multiple-occurring source columns are mapped to a separate relational table. Each row is indexed by occurrence in the source row.

The mapping contains the following transformations:

- **Normalizer transformation.** The Normalizer transformation returns multiple rows when the source contains multiple-occurring Detail_Data. It also processes different record types from the same source.
- **Router transformation.** The Router transformation routes data to targets based on the value of Hdr_Rec_Type.
- **Aggregator transformation.** The Aggregator transformation removes duplicate Detail_Data rows that occur with each Supplier_Info occurrence.

The mapping has the following functionality:

1. The Normalizer transformation passes the header record type and header store number columns to the Sales_Header target. Each Sales_Header record has a generated key that links the Sales_Header row to a Store_Data or Detail_Data target row. The Normalizer returns Hdr_Data and Store_Data once per row.
2. The Normalizer transformation passes all columns to the Router transformation. It passes Detail_Data data four times per row, once for each occurrence of the Supplier_Info columns. The Detail_Data columns contain duplicate data, except for the Supplier_Info columns.
3. The Router transformation passes the store name, address, city, and generated key to Store_Data when the Hdr_Rec_Type is "S." The generated key links Store_Data rows to Sales_Header rows.
The Router transformation contains one user-defined group for the store data and one user-defined group for the merchandise items.
4. The Router transformation passes the item, item description, price, quantity, and Detail_Data generated keys to an Aggregator transformation when the Hdr_Rec_Type is "D."
5. The Router transformation passes the supplier code, name, and column ID to the Suppliers target when the Hdr_Rec_Type is "D". It passes the generated key that links the Suppliers row to the Detail_Data row.

- The Aggregator transformation removes the duplicate Detail_Data columns. The Aggregator passes one instance of the item, description, price, quantity, and generated key to Detail_Data. The Detail_Data generated key links the Detail_Data rows to the Suppliers rows. Detail_Data also has a key that links the Detail_Data rows to the Sales_Header rows.

The following figure shows the user-defined groups and the filter conditions in the Router transformation:

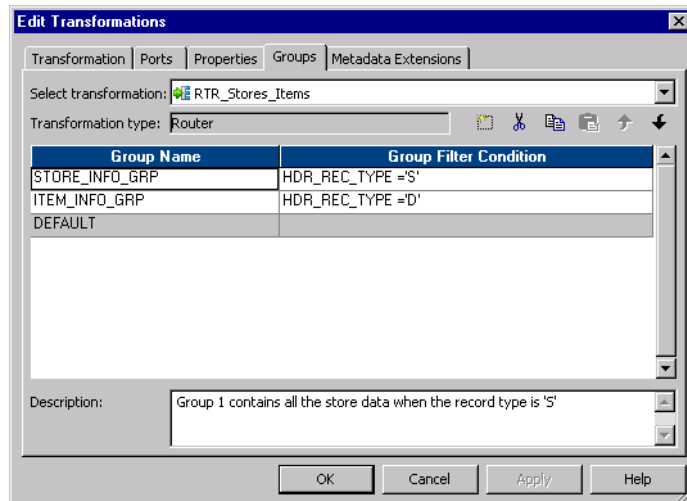

The Router transformation passes store data or item data based on the record type.

Generating Key Values

The Normalizer transformation creates a generated key when the COBOL source contains a group of multiple-occurring columns. You can pass a group of multiple-occurring columns to a different target than the other columns in the row. You can create a primary-foreign key relationship between the targets with the generated key.

The following figure shows a COBOL source definition that contains a multiple-occurring group of columns:

Name	Level	Occurs	Datatype	Length
DETAIL_RECORD	1	0		0
DETAIL_ITEM	3	0	number	9
DETAIL_DESC	3	0	string	30
DETAIL_PRICE	3	0	number	6
DETAIL_QTY	3	0	number	5
DETAIL_SUPPLIERS	3	4	number	0
SUPPLIER_CODE	10	0	string	2
SUPPLIER_NAME	10	0	string	8

In this example, the Detail_Suppliers group of columns occurs four times in the Detail_Record.

The Normalizer transformation generates a GK_Detail_Sales key for each source row. The GK_Detail_Sales key represents one Detail_Record source row.

The following figure shows the primary foreign key relationships between the targets:

Key Types	Name	Datatype	Length...
FOREIGN KEY	GK_Detail_Sales	int	10
NOT A KEY	SUPPLIER_CODE	varchar	2
NOT A KEY	SUPPLIER_NAME	varchar	8

Key Types	Name	Datatype	Length...
PRIMARY KEY	GK_Detail_Sales	int	10
NOT A KEY	DETAIL_ITEM	numeric	9
NOT A KEY	DETAIL_DESC	varchar	30
NOT A KEY	DETAIL_PRICE	numeric	6
NOT A KEY	DETAIL_QTY	numeric	5

Multiple-occurring Detail_Supplier rows have a foreign key linking them to the same Detail_Sales row. The Detail_Sales target has a one-to-many relationship to the Detail_Suppliers target.

The following figure shows the GK_Detail_Sales generated key connected to primary and foreign keys in the target:

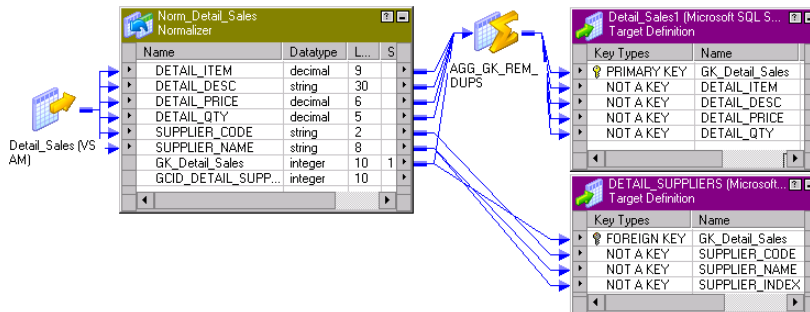

Pass GK_Detail_Sales to the primary key of Detail_Sales and the foreign key of Detail_Suppliers.

Link the Normalizer output columns to the following objects:

- **Detail_Sales_Target.** Pass the Detail_Item, Detail_Desc, Detail_Price, and Detail_Qty columns to a Detail_Sales target. Pass the GK_Detail_Sales key to the Detail_Sales primary key.
- **Aggregator Transformation.** Pass each Detail_Sales row through an Aggregator transformation to remove duplicate rows. The Normalizer returns duplicate Detail_Sales columns for each occurrence of Detail_Suppliers.
- **Detail_Suppliers.** Pass each instance of the Detail_Suppliers columns to a the Detail_Suppliers target. Pass the GK_Detail_Sales key to the Detail_Suppliers foreign key. Each instance of the Detail_Suppliers columns has a foreign key that relates the Detail_Suppliers row to the Detail_Sales row.

Troubleshooting Normalizer Transformations

I cannot edit the ports in my Normalizer transformation when using a relational source.

When you create ports manually, add them on the Normalizer tab in the transformation, not the Ports tab.

Importing a COBOL file failed with numberrors. What should I do?

Verify that the COBOL program follows the COBOL standard, including spaces, tabs, and end of line characters. The COBOL file headings should be similar to the following text:

```
identification division.  
    program-id. mead.  
environment division.  
    select file-one assign to "fname".  
data division.  
file section.  
fd FILE-ONE.
```

The Designer does not read hidden characters in the COBOL program. Use a text-only editor to make changes to the COBOL file. Do not use Word or Wordpad. Remove extra spaces.

A session that reads binary data completed, but the information in the target table is incorrect.

Edit the session in the Workflow Manager and verify that the source file format is set correctly. The file format might be EBCDIC or ASCII. The number of bytes to skip between records must be set to 0.

I have a COBOL field description that uses a non-IBM COMP type. How should I import the source?

In the source definition, clear the IBM COMP option.

In my mapping, I use one Expression transformation and one Lookup transformation to modify two output ports from the Normalizer transformation. The mapping concatenates them into a single transformation. All the ports are under the same level. When I check the data loaded in the target, it is incorrect. Why is that?

You can only concatenate ports from level one. Remove the concatenation.

CHAPTER 21

Rank Transformation

This chapter includes the following topics:

- [Rank Transformation Overview, 356](#)
- [Ports in a Rank Transformation, 357](#)
- [Defining Groups, 358](#)
- [Creating a Rank Transformation, 359](#)

Rank Transformation Overview

You can select only the top or bottom rank of data with a Rank transformation. The Rank transformation is an active transformation. Use a Rank transformation to return the largest or smallest numeric value in a port or group. You can also use a Rank transformation to return the strings at the top or the bottom of a session sort order. During the session, the Integration Service caches input data until it can perform the rank calculations.

The Rank transformation differs from the transformation functions MAX and MIN, in that it lets you select a group of top or bottom values, not just one value. For example, use Rank to select the top 10 salespersons in a given territory. Or, to generate a financial report, you might also use a Rank transformation to identify the three departments with the lowest expenses in salaries and overhead. While the SQL language provides many functions designed to handle groups of data, identifying top or bottom strata within a set of rows is not possible using standard SQL functions.

You connect all ports representing the same row set to the transformation. Only the rows that fall within that rank, based on some measure you set when you configure the transformation, pass through the Rank transformation. You can also write expressions to transform data or perform calculations.

The following figure shows a mapping that passes employee data from a human resources table through a Rank transformation. The Rank transformation only passes the rows for the top 10 highest paid employees to the next transformation.

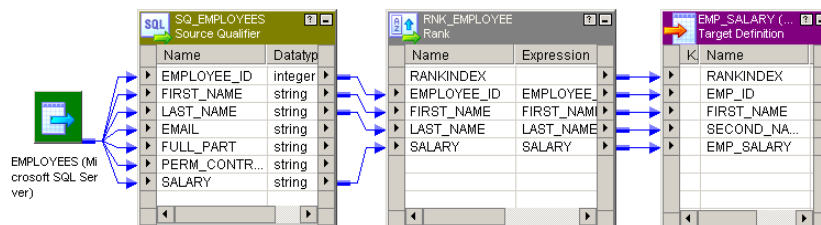

As an active transformation, the Rank transformation might change the number of rows passed through it. You might pass 100 rows to the Rank transformation, but select to rank only the top 10 rows, which pass from the Rank transformation to another transformation.

You can connect ports from only one transformation to the Rank transformation. You can also create local variables and write non-aggregate expressions.

Ranking String Values

When the Integration Service runs in the ASCII data movement mode, it sorts session data using a binary sort order.

When the Integration Service runs in Unicode data movement mode, the Integration Service uses the sort order configured for the session. You select the session sort order in the session properties. The session properties lists all available sort orders based on the code page used by the Integration Service.

For example, you have a Rank transformation configured to return the top three values of a string port. When you configure the workflow, you select the Integration Service on which you want the workflow to run. The session properties display all sort orders associated with the code page of the selected Integration Service, such as French, German, and Binary. If you configure the session to use a binary sort order, the Integration Service calculates the binary value of each string, and returns the three rows with the highest binary values for the string.

Rank Caches

During a session, the Integration Service compares an input row with rows in the data cache. If the input row out-ranks a cached row, the Integration Service replaces the cached row with the input row. If you configure the Rank transformation to rank across multiple groups, the Integration Service ranks incrementally for each group it finds.

The Integration Service stores group information in an index cache and row data in a data cache. If you create multiple partitions in a pipeline, the Integration Service creates separate caches for each partition.

Rank Transformation Properties

When you create a Rank transformation, you can configure the following properties:

- Enter a cache directory.
- Select the top or bottom rank.
- Select the input/output port that contains values used to determine the rank. You can select only one port to define a rank.
- Select the number of rows falling within a rank.
- Define groups for ranks, such as the 10 least expensive products for each manufacturer.

Ports in a Rank Transformation

The Rank transformation includes input or input/output ports connected to another transformation in the mapping. It also includes variable ports and a rank port. Use the rank port to specify the column you want to rank.

The following table describes the ports in a Rank transformation:

Ports	Number Required	Description
I	Minimum of one	Input port. Create an input port to receive data from another transformation.
O	Minimum of one	Output port. Create an output port for each port you want to link to another transformation. You can designate input ports as output ports.
V	Not Required	Variable port. Can use to store values or calculations to use in an expression. Variable ports cannot be input or output ports. They pass data within the transformation only.
R	One only	Rank port. Use to designate the column for which you want to rank values. You can designate only one Rank port in a Rank transformation. The Rank port is an input/output port. You must link the Rank port to another transformation.

Rank Index

The Designer creates a RANKINDEX port for each Rank transformation. The Integration Service uses the Rank Index port to store the ranking position for each row in a group.

For example, if you create a Rank transformation that ranks the top five salespersons for each quarter, the rank index numbers the salespeople from 1 to 5:

RANKINDEX	SALES_PERSON	SALES
1	Sam	10,000
2	Mary	9,000
3	Alice	8,000
4	Ron	7,000
5	Alex	6,000

The RANKINDEX is an output port only. You can pass the rank index to another transformation in the mapping or directly to a target.

Defining Groups

Like the Aggregator transformation, the Rank transformation lets you group information. For example, if you want to select the 10 most expensive items by manufacturer, you would first define a group for each manufacturer. When you configure the Rank transformation, you can set one of its input/output ports as a group by port. For each unique value in the group port, the transformation creates a group of rows falling within the rank definition (top or bottom, and a particular number in each rank).

Therefore, the Rank transformation changes the number of rows in two different ways. By filtering all but the rows falling within a top or bottom rank, you reduce the number of rows that pass through the transformation. By defining groups, you create one set of ranked rows for each group.

For example, you might create a Rank transformation to identify the 50 highest paid employees in the company. In this case, you would identify the SALARY column as the input/output port used to measure the ranks, and configure the transformation to filter out all rows except the top 50.

After the Rank transformation identifies all rows that belong to a top or bottom rank, it then assigns rank index values. In the case of the top 50 employees, measured by salary, the highest paid employee receives a rank index of 1. The next highest-paid employee receives a rank index of 2, and so on. When measuring a bottom rank, such as the 10 lowest priced products in the inventory, the Rank transformation assigns a rank index from lowest to highest. Therefore, the least expensive item would receive a rank index of 1.

If two rank values match, they receive the same value in the rank index and the transformation skips the next value. For example, if you want to see the top five retail stores in the country and two stores have the same sales, the return data might look similar to the following:

RANKINDEX	SALES	STORE
1	10000	Orange
1	10000	Brea
3	90000	Los Angeles
4	80000	Ventura

Creating a Rank Transformation

You can add a Rank transformation anywhere in the mapping after the source qualifier.

To create a Rank transformation:

1. In the Mapping Designer, click Transformation > Create. Select the Rank transformation. Enter a name for the Rank. The naming convention for Rank transformations is `RNK_TransformationName`.
Enter a description for the transformation. This description appears in the Repository Manager.
2. Click Create, and then click Done.
The Designer creates the Rank transformation.
3. Link columns from an input transformation to the Rank transformation.
4. Click the Ports tab and select the Rank (R) option for the rank port.
If you want to create groups for ranked rows, select Group By for the port that defines the group.
5. Click the Properties tab and select whether you want the top or bottom rank.
6. For the Number of Ranks option, enter the number of rows you want to select for the rank.
7. Change the other Rank transformation properties, if necessary.

The following table describes the Rank transformation properties:

Setting	Description
Cache Directory	Local directory where the Integration Service creates the index and data cache files. By default, the Integration Service uses the directory entered in the Workflow Manager for the process variable \$PMCacheDir. If you enter a new directory, make sure the directory exists and contains enough disk space for the cache files.
Top/Bottom	Specifies whether you want the top or bottom ranking for a column.
Number of Ranks	Number of rows you want to rank.
Case-Sensitive String Comparison	When running in Unicode mode, the Integration Service ranks strings based on the sort order selected for the session. If the session sort order is case sensitive, select this option to enable case-sensitive string comparisons, and clear this option to have the Integration Service ignore case for strings. If the sort order is not case sensitive, the Integration Service ignores this setting. By default, this option is selected.
Tracing Level	Determines the amount of information the Integration Service writes to the session log about data passing through this transformation in a session.
Rank Data Cache Size	Data cache size for the transformation. Default is 2,000,000 bytes. If the total configured session cache size is 2 GB (2,147,483,648 bytes) or more, you must run the session on a 64-bit Integration Service. You can use a numeric value for the cache, you can use a cache value from a parameter file or you can configure the Integration Service to set the cache size by using the Auto setting. If you configure the Integration Service to determine the cache size, you can also configure a maximum amount of memory for the Integration Service to allocate to the cache.
Rank Index Cache Size	Index cache size for the transformation. Default is 1,000,000 bytes. If the total configured session cache size is 2 GB (2,147,483,648 bytes) or more, you must run the session on a 64-bit Integration Service. You can use a numeric value for the cache, you can use a cache value from a parameter file or you can configure the Integration Service to set the cache size by using the Auto setting. If you configure the Integration Service to determine the cache size, you can also configure a maximum amount of memory for the Integration Service to allocate to the cache.
Transformation Scope	Specifies how the Integration Service applies the transformation logic to incoming data: <ul style="list-style-type: none"> - Transaction. Applies the transformation logic to all rows in a transaction. Choose Transaction when a row of data depends on all rows in the same transaction, but does not depend on rows in other transactions. - All Input. Applies the transformation logic on all incoming data. When you choose All Input, the PowerCenter drops incoming transaction boundaries. Choose All Input when a row of data depends on all rows in the source.

8. Click OK.

CHAPTER 22

Router Transformation

This chapter includes the following topics:

- [Router Transformation Overview, 361](#)
- [Working with Groups, 363](#)
- [Working with Ports, 365](#)
- [Connecting Router Transformations in a Mapping, 366](#)
- [Creating a Router Transformation, 366](#)

Router Transformation Overview

A Router transformation is similar to a Filter transformation because both transformations allow you to use a condition to test data. A Filter transformation tests data for one condition and drops the rows of data that do not meet the condition. However, a Router transformation tests data for one or more conditions and gives you the option to route rows of data that do not meet any of the conditions to a default output group. The Router transformation is an active transformation.

If you need to test the same input data based on multiple conditions, use a Router transformation in a mapping instead of creating multiple Filter transformations to perform the same task. The Router transformation is more efficient. For example, to test data based on three conditions, you only need one Router transformation instead of three filter transformations to perform this task. Likewise, when you use a Router transformation in a mapping, the Integration Service processes the incoming data only once. When you use multiple Filter transformations in a mapping, the Integration Service processes the incoming data for each transformation.

The following figure shows two mappings that perform the same task. The first mapping uses three Filter transformations while the second mapping produces the same result with one Router transformation:

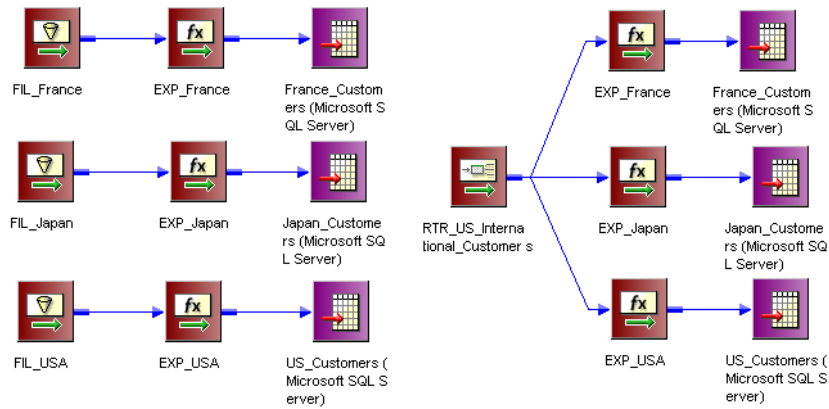

A Router transformation consists of input and output groups, input and output ports, group filter conditions, and properties that you configure in the Designer.

The following figure shows a sample Router transformation:

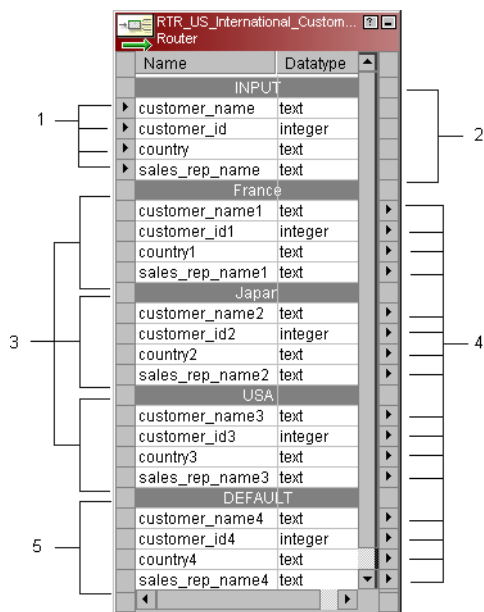

1. Input ports.
2. Input group.
3. User-defined output groups.
4. Output ports
5. Default output group

Working with Groups

A Router transformation has the following types of groups:

- Input
- Output

Input Group

The Designer copies property information from the input ports of the input group to create a set of output ports for each output group.

Output Groups

There are two types of output groups:

- User-defined groups
- Default group

You cannot modify or delete output ports or their properties.

User-Defined Groups

You create a user-defined group to test a condition based on incoming data. A user-defined group consists of output ports and a group filter condition. You can create and edit user-defined groups on the Groups tab with the Designer. Create one user-defined group for each condition that you want to specify.

The Integration Service uses the condition to evaluate each row of incoming data. It tests the conditions of each user-defined group before processing the default group. The Integration Service determines the order of evaluation for each condition based on the order of the connected output groups. The Integration Service processes user-defined groups that are connected to a transformation or a target in a mapping. The Integration Service only processes user-defined groups that are *not* connected in a mapping if the default group is connected to a transformation or a target.

If a row meets more than one group filter condition, the Integration Service passes this row multiple times.

The Default Group

The Designer creates the default group after you create one new user-defined group. The Designer does not allow you to edit or delete the default group. This group does not have a group filter condition associated with it. If *all* of the conditions evaluate to FALSE, the Integration Service passes the row to the default group. If you want the Integration Service to drop all rows in the default group, do not connect it to a transformation or a target in a mapping.

The Designer deletes the default group when you delete the last user-defined group from the list.

Using Group Filter Conditions

You can test data based on one or more group filter conditions. You create group filter conditions on the Groups tab using the Expression Editor. You can enter any expression that returns a single value. You can also specify a constant for the condition. A group filter condition returns TRUE or FALSE for each row that passes through the transformation, depending on whether a row satisfies the specified condition. Zero (0) is the equivalent of FALSE, and any non-zero value is the equivalent of TRUE. The Integration Service passes the

rows of data that evaluate to TRUE to each transformation or target that is associated with each user-defined group.

For example, you have customers from nine countries, and you want to perform different calculations on the data from only three countries. You might want to use a Router transformation in a mapping to filter this data to three different Expression transformations.

There is no group filter condition associated with the default group. However, you can create an Expression transformation to perform a calculation based on the data from the other six countries.

The following figure shows a mapping with a Router transformation that filters data based on multiple conditions:

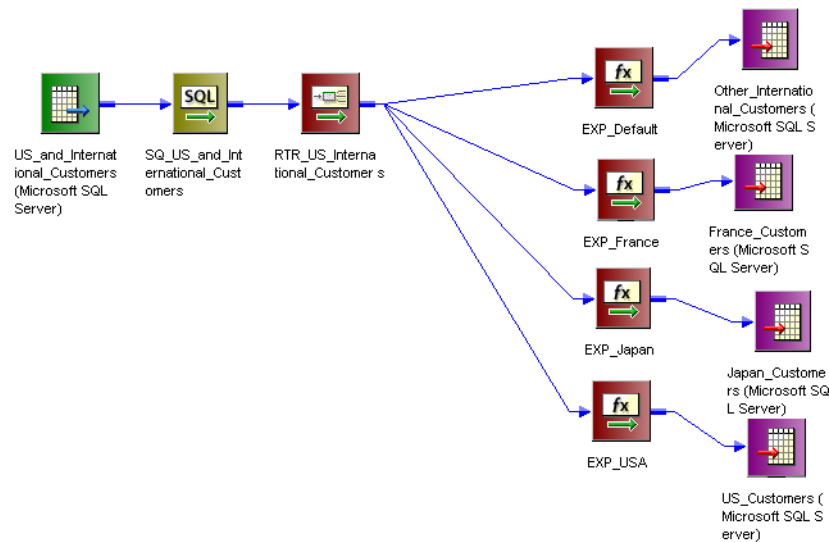

Since you want to perform multiple calculations based on the data from three different countries, create three user-defined groups and specify three group filter conditions on the Groups tab.

The following table shows group filter conditions that filter customer data:

Group Name	Group Filter Condition
France	customer_name='France'
Japan	customer_name='Japan'
USA	customer_name='USA'

In the session, the Integration Service passes the rows of data that evaluate to TRUE to each transformation or target that is associated with each user-defined group, such as Japan, France, and USA. The Integration Service passes the row to the default group if *all* of the conditions evaluate to FALSE. If this happens, the Integration Service passes the data of the other six countries to the transformation or target that is associated with the default group. If you want the Integration Service to drop all rows in the default group, do not connect it to a transformation or a target in a mapping.

The Router transformation passes data through each group that meets the condition. So, if data meets three output group conditions, the Router transformation passes the data through three output groups.

For example, you configure the following group conditions in a Router transformation:

Group Name	Group Filter Condition
Output Group 1	employee_salary > 1000
Output Group 2	employee_salary > 2000

When the Router transformation processes an input row data with employee_salary=3000, it routes the data through output groups 1 and 2.

Adding Groups

Adding a group is similar to adding a port in other transformations. The Designer copies property information from the input ports to the output ports.

To add a group to a Router transformation:

1. Click the Groups tab.
2. Click the Add button.
3. Enter a name for the new group in the Group Name section.
4. Click the Group Filter Condition field and open the Expression Editor.
5. Enter the group filter condition.
6. Click Validate to check the syntax of the condition.
7. Click OK.

Working with Ports

A Router transformation has input ports and output ports. Input ports are in the input group, and output ports are in the output groups. You can create input ports by copying them from another transformation or by manually creating them on the Ports tab.

The Designer creates output ports by copying the following properties from the input ports:

- Port name
- Datatype
- Precision
- Scale
- Default value

When you make changes to the input ports, the Designer updates the output ports to reflect these changes. You cannot edit or delete output ports. The output ports display in the Normal view of the Router transformation.

The Designer creates output port names based on the input port names. For each input port, the Designer creates a corresponding output port in each output group.

Connecting Router Transformations in a Mapping

When you connect transformations to a Router transformation in a mapping, consider the following rules:

- You can connect one group to one transformation or target.
- You can connect one output port in a group to multiple transformations or targets.
- You can connect multiple output ports in one group to multiple transformations or targets.
- You cannot connect more than one group to one target or a single input group transformation.
- You can connect more than one group to a multiple input group transformation, except for Joiner transformations, when you connect each output group to a different input group.

Creating a Router Transformation

To add a Router transformation to a mapping, complete the following steps:

1. In the Mapping Designer, open a mapping.
2. Click Transformation > Create.
Select Router transformation, and enter the name of the new transformation. The naming convention for the Router transformation is *RTR_TransformationName*. Click Create, and then click Done.
3. Select and drag all the ports from a transformation to add them to the Router transformation, or you can manually create input ports on the Ports tab.
4. Double-click the title bar of the Router transformation to edit transformation properties.
5. Click the Transformation tab and configure transformation properties.
6. Click the Properties tab and configure tracing levels.
7. Click the Groups tab, and then click the Add button to create a user-defined group.
The Designer creates the default group when you create the first user-defined group.
8. Click the Group Filter Condition field to open the Expression Editor.
9. Enter a group filter condition.
10. Click Validate to check the syntax of the conditions you entered.
11. Click OK.
12. Connect group output ports to transformations or targets.

CHAPTER 23

Sequence Generator Transformation

This chapter includes the following topics:

- [Sequence Generator Transformation Overview, 367](#)
- [Sequence Generator Ports, 368](#)
- [Sequence Generator Transformation Properties, 371](#)
- [Sequence Generator Advanced Properties, 376](#)
- [Creating a Sequence Generator Transformation, 376](#)
- [Sequence Generator Transformation in a Non-native Environment, 377](#)

Sequence Generator Transformation Overview

The Sequence Generator transformation is a passive transformation that generates numeric values. Use the Sequence Generator transformation to create unique primary key values, replace missing primary keys, or cycle through a sequential range of numbers.

The Sequence Generator transformation is a connected transformation. It contains two output ports that you can connect to one or more transformations. The Integration Service generates a block of sequence numbers each time a block of rows enters a connected transformation. If you connect CURRVAL, the Integration Service processes one row in each block. When NEXTVAL is connected to the input port of another transformation, the Integration Service generates a sequence of numbers. When CURRVAL is connected to the input port of another transformation, the Integration Service generates the NEXTVAL value plus the Increment By value.

You can create a Sequence Generator transformation to use in a single mapping, or you can create a reusable Sequence Generator transformation to use in multiple mappings. A reusable Sequence Generator transformation maintains the integrity of the sequence in each mapping that uses an instance of the Sequence Generator transformation.

You can make a Sequence Generator transformation reusable, and use it in multiple mappings. You might reuse a Sequence Generator transformation when you perform multiple loads to a single target.

For example, if you have a large input file that you separate into three sessions running in parallel, use a Sequence Generator transformation to generate primary key values. If you use different Sequence Generator transformations, the Integration Service might generate duplicate key values. Instead, use the reusable Sequence Generator transformation for all three sessions to provide a unique value for each target row.

Sequence Generator Ports

The Sequence Generator transformation has two output ports: NEXTVAL and CURRVAL. You cannot edit or delete these ports. Likewise, you cannot add ports to the transformation.

NEXTVAL Port

You can connect NEXTVAL to a transformation to generate unique values for each row in the transformation. Connect the NEXTVAL port to a downstream transformation or target to generate a sequence of numbers. If you connect NEXTVAL to multiple transformations, the Integration Service generates the same sequence of numbers for each transformation.

You connect the NEXTVAL port to generate the sequence based on the Start Value and Increment Value properties. If the Sequence Generator is not configured to cycle through the sequence, the NEXTVAL port generates sequence numbers up to the configured end value.

The following image shows a mapping with the Sequence Generator transformation NEXTVAL port connected to two targets to generate primary and foreign key values:

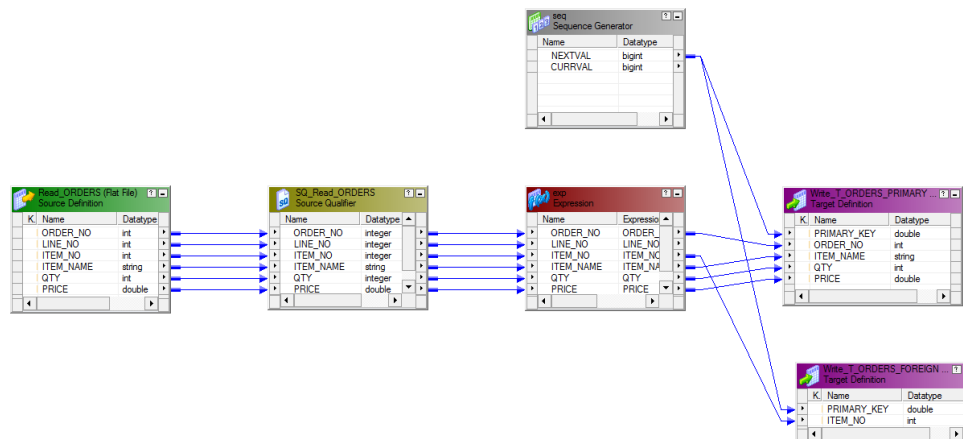

When you configure the Sequence Generator transformation with a Start Value = 1 and an Increment Value = 1, the Integration Service generates the same primary key values for the T_ORDERS_PRIMARY and T_ORDERS_FOREIGN target tables.

Connect NEXTVAL to multiple transformations to generate unique values for each row in each transformation. Use the NEXTVAL port to generate sequence numbers by connecting it to a downstream transformation or target. You connect the NEXTVAL port to generate the sequence based on the Current Value and Increment By properties. If the Sequence Generator is not configured to cycle through the sequence, the NEXTVAL port generates sequence numbers up to the configured End Value.

For example, you might connect NEXTVAL to two targets in a mapping to generate unique primary key values. The Integration Service creates a column of unique primary key values for each target table. The column of unique primary key values is sent to one target table as a block of sequence numbers. The other target receives a block of sequence numbers from the Sequence Generator transformation after the first target receives the block of sequence numbers.

For example, you configure the Sequence Generator transformation as follows: Current Value = 1, Increment By = 1. The Integration Service generates the following primary key values for the T_ORDERS_PRIMARY and T_ORDERS_FOREIGN target tables:

<p>T_ORDERS_PRIMARY TABLE: PRIMARY KEY</p> <p>1</p> <p>2</p> <p>3</p> <p>4</p> <p>5</p>	<p>T_ORDERS_FOREIGN TABLE: PRIMARY KEY</p> <p>6</p> <p>7</p> <p>8</p> <p>9</p> <p>10</p>
---	--

If you want the *same* values to go to more than one target that receives data from a single transformation, you can connect a Sequence Generator transformation to that preceding transformation. The Integration Service processes the values into a block of sequence numbers. This allows the Integration Service to pass unique values to the transformation, and then route rows from the transformation to targets.

The following figure shows a mapping with a Sequence Generator that passes unique values to the Expression transformation:

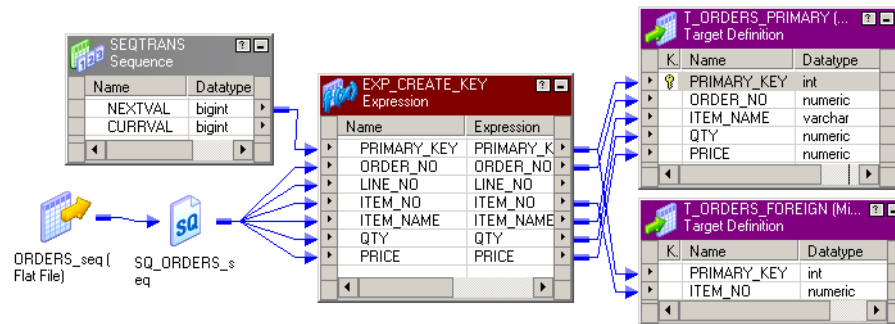

The Expression transformation populates both targets with identical primary key values.

For example, you configure the Sequence Generator transformation as follows: Current Value = 1, Increment By = 1. The Integration Service generates the following primary key values for the T_ORDERS_PRIMARY and T_ORDERS_FOREIGN target tables:

<p>T_ORDERS_PRIMARY TABLE: PRIMARY KEY</p> <p>1</p> <p>2</p> <p>3</p> <p>4</p> <p>5</p>	<p>T_ORDERS_FOREIGN TABLE: PRIMARY KEY</p> <p>1</p> <p>2</p> <p>3</p> <p>4</p> <p>5</p>
---	---

Note: When you run a partitioned session on a grid, the Sequence Generator transformation skips values depending on the number of rows in each partition.

Create Keys

You can create primary or foreign key values with the Sequence Generator transformation by connecting the NEXTVAL port to a target or downstream transformation. You can use a range of values from 1 to 9,223,372,036,854,775,807 with the smallest interval of 1.

When you create primary or foreign keys, use the Cycle option to prevent the Integration Service from creating duplicate primary keys. You can do this by selecting the Truncate Target Table option in the session properties or by creating composite keys.

To create a composite key, you can configure the Integration Service to cycle through a smaller set of values. For example, if three stores generate order numbers, configure a Sequence Generator transformation to cycle through values from 1 to 3, incrementing by 1. When you connect the ORDER_NO port to the Sequence Generator transformation, the generated values create unique composite keys.

The following example shows composite keys and order numbers:

COMPOSITE_KEY	ORDER_NO
1	12345
2	12345
3	12345
1	12346
2	12346
3	12346

Replace Missing Values

Use the Sequence Generator transformation to replace missing keys by using NEXTVAL with the IIF and ISNULL functions.

For example, to replace null values in the ORDER_NO column, you create a Sequence Generator transformation with the properties and drag the NEXTVAL port to an Expression transformation. In the Expression transformation, drag the ORDER_NO port into the transformation along with any other required ports. Then create an output port, ALL_ORDERS.

In ALL_ORDERS, you can then enter the following expression to replace null orders:

```
IIF( ISNULL( ORDER_NO ), NEXTVAL, ORDER_NO )
```

CURRVAL

CURRVAL is NEXTVAL plus the Increment Value. You typically only connect the CURRVAL port when the NEXTVAL port is already connected to a downstream transformation. When a row enters a transformation connected to the CURRVAL port, the Integration Service passes the last created NEXTVAL value plus one.

The following figure shows connecting CURRVAL and NEXTVAL ports to a target:

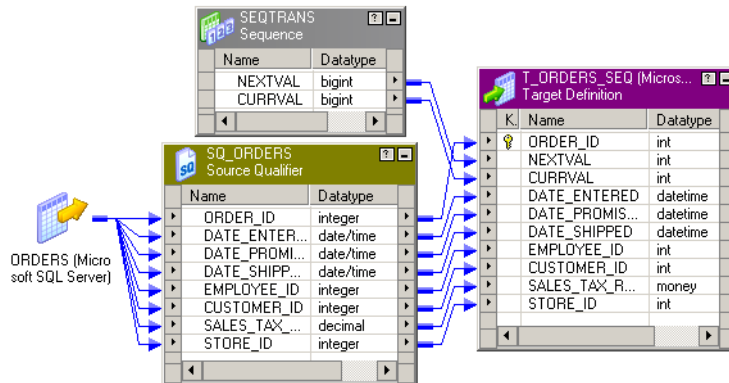

For example, you configure the Sequence Generator transformation as follows: Current Value = 1, Increment By = 1. The Integration Service generates the following values for NEXTVAL and CURRVAL:

NEXTVAL	CURRVAL
1	2
2	3
3	4
4	5
5	6

If you connect the CURRVAL port without connecting the NEXTVAL port, the Integration Service passes a constant value for each row. When you connect the CURRVAL port in a Sequence Generator transformation, the Integration Service processes one row in each block. You can optimize performance by connecting only the NEXTVAL port in a mapping.

Note: When you run a partitioned session on a grid, the Sequence Generator transformation might skip values depending on the number of rows in each partition.

Sequence Generator Transformation Properties

Configure transformation properties that the Integration Service uses to generate sequential values.

The following list describes the Sequence Generator transformation properties that you can configure:

Start Value

Start value of the generated sequence that you want the Integration Service to use if you use the Cycle option. If you select Cycle, the Integration Service cycles back to this value when it reaches the end value.

Default is 0.

Maximum value is 9,223,372,036,854,775,806.

Increment By

Difference between two consecutive values from the NEXTVAL port.

Default is 1.

Must be a positive integer.

Maximum value is 2,147,483,647.

End Value

Maximum value that the Integration Service generates. If the Integration Service reaches this value during the session and the sequence is not configured to cycle, the session fails.

Maximum value is 9,223,372,036,854,775,807.

If you connect the NEXTVAL port to a downstream integer port, set the end value to a value no larger than the integer maximum value. If the NEXTVAL exceeds the datatype maximum value for the downstream port, the session fails.

Current Value

Current value of the sequence. Enter the value you want the Integration Service to use as the first value in the sequence. To cycle through a series of values, the value must be greater than or equal to the start value and less than the end value.

If the Number of Cached Values is set to 0, the Integration Service updates the current value to reflect the last-generated value for the session plus one, and then uses the updated current value as the basis for the next time you run this session. However, if you use the Reset option, the Integration Service resets this value to its original value after each session.

Note: If you edit this setting, you reset the sequence to the new setting. If you reset Current Value to 10, and the increment is 1, the next time you use the session, the Integration Service generates a first value of 10.

Maximum value is 9,223,372,036,854,775,806. The Integration Service sets the value to NULL if the current value exceeds the maximum value.

Cycle

If enabled, the Integration Service cycles through the sequence range and starts over with the start value.

If disabled, the Integration Service stops the sequence at the configured end value. The Integration Service fails the session with overflow errors if it reaches the end value and still has rows to process.

Number of Cached Values

Number of sequential values the Integration Service caches at a time. Use this option when multiple sessions use the same reusable Sequence Generator at the same time to ensure each session receives unique values. The Integration Service updates the repository as it caches each value. When set to 0, the Integration Service does not cache values.

Default value is 0.

Default value for a reusable Sequence Generator is 1,000.

Maximum value is 9,223,372,036,854,775,807.

This property is applicable only for the reusable Sequence Generator transformations.

Reset

If enabled, the Integration Service generates values based on the original current value for each session. If disabled, the Integration Service updates the current value to reflect the last-generated value for the session plus one, and then uses the updated current value as the basis for the next session run.

This property is applicable only for the non-reusable Sequence Generator transformations.

Tracing Level

Level of detail about the transformation that the Integration Service writes into the session log.

Start Value

Use Cycle to generate a repeating sequence, such as numbers 1 through 12 to correspond to the months in a year.

1. Enter the lowest value in the sequence that you want the Integration Service to use for the start value.
2. Enter the highest value to be used for End Value.
3. Select Cycle.

As it cycles, the Integration Service reaches the configured end value for the sequence, it wraps around and starts the cycle again, beginning with the configured start value.

Increment By

The Integration Service generates a sequence in the NEXTVAL port based on the Current Value and Increment By properties in the Sequence Generator transformation.

The Current Value property is the value at which the Integration Service starts creating the sequence for each session. Increment By is the integer the Integration Service adds to the existing value to create the new value in the sequence. By default, the Current Value is set to 1, and Increment By is set to 1.

For example, you might create a Sequence Generator transformation with a current value of 1,000 and an increment of 10. If you pass three rows through the mapping, the Integration Service generates the following set of values:

```
1000  
1010  
1020
```

End Value

End Value is the maximum value that you want the Integration Service to generate. If the Integration Service reaches the end value and the Sequence Generator is not configured to cycle through the sequence, the session fails with an overflow error.

Set the end value to any integer between 1 and 9,233,372,036,854,775,807. If you connect the NEXTVAL port to a downstream integer port, set the end value to a value no larger than the integer maximum value. For example, if you connect the NEXTVAL port to a Small Integer port, set the end value to a maximum of 32,767. If the NEXTVAL exceeds the datatype maximum value for the downstream port, the session fails.

Cycle Through a Range of Values

You can establish a range of values for the Sequence Generator transformation. If you use the cycle option, the Sequence Generator transformation repeats the range when it reaches the end value.

For example, if you set the sequence range to start at 10 and end at 50, and you set an increment value of 10, the Sequence Generator transformation creates the values 10, 20, 30, 40, 50. The sequence starts over again at 10.

Current Value

The Integration Service uses the current value as the basis for generated values for each session. To indicate which value you want the Integration Service to use the first time it uses the Sequence Generator transformation, you must enter that value as the current value. If you want to use the Sequence Generator transformation to cycle through a series of values, the current value must be greater than or equal to Start Value and less than the end value.

At the end of each session, the Integration Service updates the current value to the last value generated for the session plus one if the Sequence Generator Number of Cached Values is 0. For example, if the Integration Service ends a session with a generated value of 101, it updates the Sequence Generator current value to 102 in the repository. The next time the Sequence Generator is used, the Integration Service uses 102 as the basis for the next generated value. If the Sequence Generator Increment By is 1, when the Integration Service starts another session using the Sequence Generator, the first generated value is 102.

If you have multiple versions of a Sequence Generator transformation, the Integration Service updates the current value across all versions when it runs a session. The Integration Service updates the current value across versions regardless of whether you have checked out the Sequence Generator transformation or the parent mapping. The updated current value overrides an edited current value for a Sequence Generator transformation if the two values are different.

For example, User 1 creates Sequence Generator transformation and checks it in, saving a current value of 10 to Sequence Generator version 1. Then User 1 checks out the Sequence Generator transformation and enters a new current value of 100 to Sequence Generator version 2. User 1 keeps the Sequence Generator transformation checked out. Meanwhile, User 2 runs a session that uses the Sequence Generator transformation version 1. The Integration Service uses the checked-in value of 10 as the current value when User 2 runs the session. When the session completes, the current value is 150. The Integration Service updates the current value to 150 for version 1 and version 2 of the Sequence Generator transformation even though User 1 has the Sequence Generator transformation checked out.

If you open the mapping after you run the session, the current value displays the last value generated for the session plus one. Since the Integration Service uses the current value to determine the first value for each session, you should edit the current value only when you want to reset the sequence.

If you have multiple versions of the Sequence Generator transformation, and you want to reset the sequence, you must check in the mapping or reusable Sequence Generator transformation after you modify the current value.

Note: If you configure the Sequence Generator to Reset, the Integration Service uses the current value as the basis for the first generated value for each session.

Number of Cached Values

Number of Cached Values determines the number of values the Integration Service caches at one time. When Number of Cached Values is greater than zero, the Integration Service caches the configured number of values and updates the current value each time it caches values.

When multiple sessions use the same reusable Sequence Generator transformation at the same time, there might be multiple instances of the Sequence Generator transformation. To avoid generating the same values for each session, reserve a range of sequence values for each session by configuring Number of Cached Values.

Tip: To increase performance when running a session on a grid, increase the number of cached values for the Sequence Generator transformation. This reduces the communication required between the master and worker DTM processes and the repository.

Non-Reusable Sequence Generators

For non-reusable Sequence Generator transformations, Number of Cached Values is set to zero by default, and the Integration Service does not cache values during the session. When the Integration Service does not cache values, it accesses the repository for the current value at the start of a session. The Integration Service then generates values for the sequence. At the end of the session, the Integration Service updates the current value in the repository.

When you set Number of Cached Values greater than zero, the Integration Service caches values during the session. At the start of the session, the Integration Service accesses the repository for the current value, caches the configured number of values, and updates the current value accordingly. If the Integration Service uses all values in the cache, it accesses the repository for the next set of values and updates the current value. At the end of the session, the Integration Service discards any remaining values in the cache.

For non-reusable Sequence Generator transformations, setting Number of Cached Values greater than zero can increase the number of times the Integration Service accesses the repository during the session. It also causes sections of skipped values since unused cached values are discarded at the end of each session.

For example, you configure a Sequence Generator transformation as follows: Number of Cached Values = 50, Current Value = 1, Increment By = 1. When the Integration Service starts the session, it caches 50 values for the session and updates the current value to 50 in the repository. The Integration Service uses values 1 to 39 for the session and discards the unused values, 40 to 49. When the Integration Service runs the session again, it checks the repository for the current value, which is 50. It then caches the next 50 values and updates the current value to 100. During the session, it uses values 50 to 98. The values generated for the two sessions are 1 to 39 and 50 to 98.

Reusable Sequence Generators

When you have a reusable Sequence Generator transformation in several sessions and the sessions run at the same time, use Number of Cached Values to ensure each session receives unique values in the sequence. By default, Number of Cached Values is set to 1000 for reusable Sequence Generators.

When multiple sessions use the same Sequence Generator transformation at the same time, you risk generating the same values for each session. To avoid this, have the Integration Service cache a set number of values for each session by configuring Number of Cached Values.

For example, you configure a reusable Sequence Generator transformation as follows: Number of Cached Values = 50, Current Value = 1, Increment By = 1. Two sessions use the Sequence Generator, and they are scheduled to run at approximately the same time. When the Integration Service starts the first session, it caches 50 values for the session and updates the current value to 50 in the repository. The Integration Service begins using values 1 to 50 in the session. When the Integration Service starts the second session, it checks the repository for the current value, which is 50. It then caches the next 50 values and updates the current value to 100. It then uses values 51 to 100 in the second session. When either session uses all its cached values, the Integration Service caches a new set of values and updates the current value to ensure these values remain unique to the Sequence Generator.

For reusable Sequence Generator transformations, you can reduce Number of Cached Values to minimize discarded values, however it must be greater than one. When you reduce the Number of Cached Values, you might increase the number of times the Integration Service accesses the repository to cache values during the session.

Sequence Generator Advanced Properties

Configure advanced properties that the Integration Service uses to generate sequential values.

The following list describes the Sequence Generator advanced properties you can configure:

Reset

If enabled, the Integration Service generates values based on the original current value for each session. If disabled, the Integration Service updates the current value to reflect the last-generated value for the session plus one, and then uses the updated current value as the basis for the next session run.

This property is disabled for reusable Sequence Generator transformations.

Tracing Level

Level of detail about the transformation that the Integration Service writes into the session log.

Reset

If you select Reset for a non-reusable Sequence Generator transformation, the Integration Service generates values based on the original start value each time it starts the session. Otherwise, the Integration Service updates the current value to reflect the last-generated value plus the increment value, and then uses the updated value the next time it uses the Sequence Generator transformation.

For example, you configure a Sequence Generator transformation to create values from 1 to 1,000 with an increment of 1. You choose reset to reset the start value to 1. During the first session run, the Integration Service generates numbers 1 through 234. In each subsequent mapping run, the Integration Service again generates numbers beginning with the initial value of 1.

If you do not reset, the Integration Service updates the current value to 235 at the end of the first run. The next time it uses the Sequence Generator transformation, the first value generated is 235.

Note: Reset is disabled for reusable Sequence Generator transformations.

Creating a Sequence Generator Transformation

To use a Sequence Generator transformation in a mapping, add it to the mapping, configure the transformation properties, and then connect NEXTVAL or CURRVAL to one or more transformations.

To create a Sequence Generator transformation:

1. In the Mapping Designer, click Transformation > Create. Select the Sequence Generator transformation. The naming convention for Sequence Generator transformations is *SEQ_TransformationName*.
2. Enter a name for the Sequence Generator, and click Create. Click Done. The Designer creates the Sequence Generator transformation.
3. Double-click the title bar of the transformation.
4. Enter a description for the transformation.
5. Select the Properties tab. Enter settings.

Note: You cannot override the Sequence Generator transformation properties at the session level. This protects the integrity of the sequence values generated.

6. Click OK.

7. To generate new sequences during a session, connect the NEXTVAL port to at least one transformation in the mapping.

Use the NEXTVAL or CURRVAL ports in an expression in other transformations.

Sequence Generator Transformation in a Non-native Environment

The Sequence Generator transformation processing in a non-native environment depends on the engine that runs the transformation.

Consider the support for the following non-native run-time engines:

- Blaze engine. Supported with restrictions.
- Spark engine. Supported with restrictions in batch mappings. Not supported in streaming mappings.
- Databricks Spark engine. Supported when the domain and the Databricks cluster reside in the same virtual network in AWS or Azure Databricks environments.

Sequence Generator Transformation on the Blaze Engine

A mapping with a Sequence Generator transformation consumes significant resources when the following conditions are true:

- You configure the transformation to maintain row order.
- The mapping runs in a single partition.

Sequence Generator Transformation on the Spark Engine

The Sequence Generator transformation does not maintain row order in output data. If you enable the **Maintain Row Order** property on the transformation, the Data Integration Service ignores the property.

Note: Spark sequence generator with maintain row order works fine if the data set is relatively small and can run or forced to run on a single partition.

CHAPTER 24

Sorter Transformation

This chapter includes the following topics:

- [Sorter Transformation Overview, 378](#)
- [Sorting Data, 378](#)
- [Sorter Transformation Properties, 379](#)
- [Creating a Sorter Transformation, 381](#)

Sorter Transformation Overview

You can sort data with the Sorter transformation. You can sort data in ascending or descending order according to a specified sort key. You can also configure the Sorter transformation for case-sensitive sorting, and specify whether the output rows should be distinct. The Sorter transformation is an active transformation. It must be connected to the data flow.

You can sort data from relational or flat file sources. You can also use the Sorter transformation to sort data passing through an Aggregator transformation configured to use sorted input.

When you create a Sorter transformation in a mapping, you specify one or more ports as a sort key and configure each sort key port to sort in ascending or descending order. You also configure sort criteria the Integration Service applies to all sort key ports and the system resources it allocates to perform the sort operation.

Sorting Data

The Sorter transformation contains only input/output ports. All data passing through the Sorter transformation is sorted according to a sort key. The sort key is one or more ports that you want to use as the sort criteria.

You can specify more than one port as part of the sort key. When you specify multiple ports for the sort key, the Integration Service sorts each port sequentially. The order the ports appear in the Ports tab determines the succession of sort operations. The Sorter transformation treats the data passing through each successive sort key port as a secondary sort of the previous port.

At session run time, the Integration Service sorts data according to the sort order specified in the session properties. The sort order determines the sorting criteria for special characters and symbols.

The following figure shows the Ports tab configuration for the Sorter transformation sorting the data in ascending order by order ID and item ID:

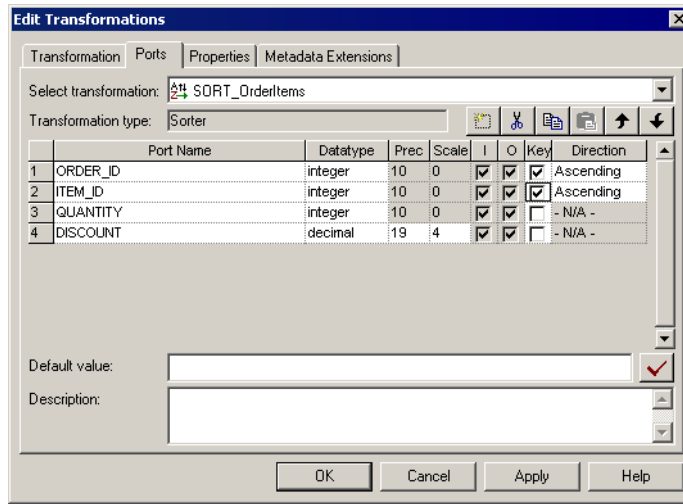

At session run time, the Integration Service passes the following rows into the Sorter transformation:

ORDER_ID	ITEM_ID	QUANTITY	DISCOUNT
45	123456	3	3.04
45	456789	2	12.02
43	000246	6	34.55
41	000468	5	.56

After sorting the data, the Integration Service passes the following rows out of the Sorter transformation:

ORDER_ID	ITEM_ID	QUANTITY	DISCOUNT
41	000468	5	.56
43	000246	6	34.55
45	123456	3	3.04
45	456789	2	12.02

Sorter Transformation Properties

The Sorter transformation has several properties that specify additional sort criteria. The Integration Service applies these criteria to all sort key ports. The Sorter transformation properties also determine the system resources the Integration Service allocates when it sorts data.

Sorter Cache Size

The Integration Service uses the Sorter Cache Size property to determine the maximum amount of memory it can allocate to perform the sort operation. The Integration Service passes all incoming data into the Sorter transformation before it performs the sort operation. You can use a numeric value for the cache, you can use a cache value from a parameter file or you can configure the Integration Service to set the cache size by using the Auto setting. If you configure the Integration Service to determine the cache size, you can also configure a maximum amount of memory for the Integration Service to allocate to the cache. If the total configured session cache size is 2 GB (2,147,483,648 bytes) or greater, you must run the session on a 64-bit Integration Service.

Before starting the sort operation, the Integration Service allocates the amount of memory configured for the Sorter cache size. If the Integration Service runs a partitioned session, it allocates the specified amount of Sorter cache memory for each partition.

If it cannot allocate enough memory, the Integration Service fails the session. For best performance, configure Sorter cache size with a value less than or equal to the amount of available physical RAM on the Integration Service machine. Allocate at least 16 MB (16,777,216 bytes) of physical memory to sort data using the Sorter transformation. Sorter cache size is set to 16,777,216 bytes by default.

If the amount of incoming data is greater than the amount of Sorter cache size, the Integration Service temporarily stores data in the Sorter transformation work directory. The Integration Service requires disk space of at least twice the amount of incoming data when storing data in the work directory. If the amount of incoming data is significantly greater than the Sorter cache size, the Integration Service may require much more than twice the amount of disk space available to the work directory.

The Integration Service also writes the amount of memory the Sorter transformation uses to the session log when you configure the Sorter transformation tracing level to Normal.

Case Sensitive

The Case Sensitive property determines whether the Integration Service considers case when sorting data. When you enable the Case Sensitive property, the Integration Service sorts uppercase characters higher than lowercase characters.

Work Directory

You must specify a work directory the Integration Service uses to create temporary files while it sorts data. After the Integration Service sorts the data, it deletes the temporary files. You can specify any directory on the Integration Service machine to use as a work directory. By default, the Integration Service uses the value specified for the `$PMTempDir` process variable.

When you partition a session with a Sorter transformation, you can specify a different work directory for each partition in the pipeline. To increase session performance, specify work directories on physically separate disks on the Integration Service system.

Distinct Output Rows

You can configure the Sorter transformation to treat output rows as distinct. If you configure the Sorter transformation for distinct output rows, the Mapping Designer configures all ports as part of the sort key. The Integration Service discards duplicate rows compared during the sort operation.

Tracing Level

Configure the Sorter transformation tracing level to control the number and type of Sorter error and status messages the Integration Service writes to the session log. At Normal tracing level, the Integration Service writes the size of the row passed to the Sorter transformation and the amount of memory the Sorter transformation allocates for the sort operation. The Integration Service also writes the time and date when it passes the first and last input rows to the Sorter transformation.

If you configure the Sorter transformation tracing level to Verbose Data, the Integration Service writes the time the Sorter transformation finishes passing all data to the next transformation in the pipeline. The Integration Service also writes the time to the session log when the Sorter transformation releases memory resources and removes temporary files from the work directory.

Null Treated Low

You can configure the way the Sorter transformation treats null values. Enable this property if you want the Integration Service to treat null values as lower than any other value when it performs the sort operation. Disable this option if you want the Integration Service to treat null values as higher than any other value.

Transformation Scope

The transformation scope specifies how the Integration Service applies the transformation logic to incoming data:

- **Transaction.** Applies the transformation logic to all rows in a transaction. Choose Transaction when a row of data depends on all rows in the same transaction, but does not depend on rows in other transactions.
- **All Input.** Applies the transformation logic on all incoming data. When you choose All Input, the PowerCenter drops incoming transaction boundaries. Choose All Input when a row of data depends on all rows in the source.

Creating a Sorter Transformation

To add a Sorter transformation to a mapping, complete the following steps:

1. In the Mapping Designer, click Transformation > Create. Select the Sorter transformation.
The naming convention for Sorter transformations is `SRT_TransformationName`. Enter a description for the transformation. This description appears in the Repository Manager, making it easier to understand what the transformation does.
2. Enter a name for the Sorter and click Create.
The Designer creates the Sorter transformation.
3. Click Done.
4. Drag the ports you want to sort into the Sorter transformation.
The Designer creates the input/output ports for each port you include.
5. Double-click the title bar of the transformation to open the Edit Transformations dialog box.
6. Select the Ports tab.
7. Select the ports you want to use as the sort key.

8. For each port selected as part of the sort key, specify whether you want the Integration Service to sort data in ascending or descending order.
9. Select the Properties tab. Modify the Sorter transformation properties.
10. Select the Metadata Extensions tab. Create or edit metadata extensions for the Sorter transformation.
11. Click OK.

CHAPTER 25

Source Qualifier Transformation

This chapter includes the following topics:

- [Source Qualifier Transformation Overview, 383](#)
- [Source Qualifier Transformation Properties, 385](#)
- [Default Query, 386](#)
- [Joining Source Data, 388](#)
- [Adding an SQL Query, 390](#)
- [Entering a User-Defined Join, 391](#)
- [Outer Join Support, 392](#)
- [Entering a Source Filter, 399](#)
- [Using Sorted Ports, 400](#)
- [Select Distinct, 401](#)
- [Adding Pre- and Post-Session SQL Commands, 401](#)
- [Creating a Source Qualifier Transformation, 402](#)
- [Troubleshooting Source Qualifier Transformations, 403](#)

Source Qualifier Transformation Overview

When you add a relational or a flat file source definition to a mapping, you need to connect it to a Source Qualifier transformation. The Source Qualifier transformation represents the rows that the Integration Service reads when it runs a session. The Source Qualifier transformation is an active transformation.

Use the Source Qualifier transformation to complete the following tasks:

- **Join data originating from the same source database.** You can join two or more tables with primary key-foreign key relationships by linking the sources to one Source Qualifier transformation.
- **Filter rows when the Integration Service reads source data.** If you include a filter condition, the Integration Service adds a WHERE clause to the default query.
- **Specify an outer join rather than the default inner join.** If you include a user-defined join, the Integration Service replaces the join information specified by the metadata in the SQL query.
- **Specify sorted ports.** If you specify a number for sorted ports, the Integration Service adds an ORDER BY clause to the default SQL query.
- **Select only distinct values from the source.** If you choose Select Distinct, the Integration Service adds a SELECT DISTINCT statement to the default SQL query.

- **Create a custom query to issue a special SELECT statement for the Integration Service to read source data.** For example, you might use a custom query to perform aggregate calculations.

Transformation Datatypes

The Source Qualifier transformation displays the transformation datatypes. The transformation datatypes determine how the source database binds data when the Integration Service reads it. Do not alter the datatypes in the Source Qualifier transformation. If the datatypes in the source definition and Source Qualifier transformation do not match, the Designer marks the mapping invalid when you save it.

Target Load Order

You specify a target load order based on the Source Qualifier transformations in a mapping. If you have multiple Source Qualifier transformations connected to multiple targets, you can designate the order in which the Integration Service loads data into the targets.

If one Source Qualifier transformation provides data for multiple targets, you can enable constraint-based loading in a session to have the Integration Service load data based on target table primary and foreign key relationships.

For example, a mapping contains three pipelines. Each pipeline contains a separate source, source qualifier, transformation, and a flat file target linked together in a mapping. You can configure the target load order for the mapping such that the Integration Service processes each target load order group sequentially.

Datetime Values

When you use a datetime value or a datetime parameter or variable in the SQL query, change the date format to the format used in the source. The Integration Service passes datetime values to source systems as strings in the SQL query. The Integration Service converts a datetime value to a string, based on the source database.

The following table describes the datetime formats for each database type:

Source	Date Format
DB2	YYYY-MM-DD-HH24:MI:SS
Informix	YYYY-MM-DD HH24:MI:SS
Microsoft SQL Server	MM/DD/YYYY HH24:MI:SS
ODBC	YYYY-MM-DD HH24:MI:SS
Oracle	MM/DD/YYYY HH24:MI:SS
Sybase	MM/DD/YYYY HH24:MI:SS
Teradata	YYYY-MM-DD HH24:MI:SS

Some databases require you to identify datetime values with additional punctuation, such as single quotation marks or database specific functions. For example, to convert the \$\$\$SessStartTime value for an Oracle source, use the following Oracle function in the SQL override:

```
to_date ('$$$SessStartTime', 'mm/dd/yyyy hh24:mi:ss')
```

For Informix, use the following Informix function in the SQL override to convert the \$\$\$SessStartTime value:

```
DATE TIME ($$$SessStartTime) YEAR TO SECOND
```

For information about database specific functions, see the database documentation.

Parameters and Variables

You can use parameters and variables in the SQL query, user-defined join, source filter, and pre- and post-session SQL commands of a Source Qualifier transformation. Use any parameter or variable type that you can define in the parameter file. You can enter a parameter or variable within the SQL statement, or you can use a parameter or variable as the SQL query. For example, you can use a session parameter, \$ParamMyQuery, as the SQL query, and set \$ParamMyQuery to the SQL statement in a parameter file.

The Integration Service first generates an SQL query and expands each parameter or variable. It replaces each mapping parameter, mapping variable, and workflow variable with its start value. Then it runs the query on the source database.

When you use a string mapping parameter or variable in the Source Qualifier transformation, use a string identifier appropriate to the source system. Most databases use a single quotation mark as a string identifier. For example, to use the string parameter \$\$IPAddress in a source filter for a Microsoft SQL Server database table, enclose the parameter in single quotes as follows: '\$\$IPAddress.'

When you use a datetime mapping parameter or variable, or when you use the built-in variable \$\$SessStartTime, change the date format to the format used in the source. The Integration Service passes datetime values to source systems as strings in the SQL query.

Tip: To ensure the format of a datetime parameter or variable matches that used by the source, validate the SQL query.

Source Qualifier Transformation Properties

Configure the following Source Qualifier transformation properties on the Properties tab:

Option	Description
SQL Query	Defines a custom query that replaces the default query the Integration Service uses to read data from sources represented in this Source Qualifier transformation. A custom query overrides entries for a custom join or a source filter.
User-Defined Join	Specifies the condition used to join data from multiple sources represented in the same Source Qualifier transformation.
Source Filter	Specifies the filter condition the Integration Service applies when querying rows.
Number of Sorted Ports	Indicates the number of columns used when sorting rows queried from relational sources. If you select this option, the Integration Service adds an ORDER BY to the default query when it reads source rows. The ORDER BY includes the number of ports specified, starting from the top of the transformation. When selected, the database sort order must match the session sort order.
Tracing Level	Sets the amount of detail included in the session log when you run a session containing this transformation.

Option	Description
Select Distinct	Specifies if you want to select only unique rows. The Integration Service includes a SELECT DISTINCT statement if you choose this option.
Pre-SQL	Pre-session SQL commands to run against the source database before the Integration Service reads the source.
Post-SQL	Post-session SQL commands to run against the source database after the Integration Service writes to the target.
Output is Deterministic	Relational source or transformation output that does not change between session runs when the input data is consistent between runs. When you configure this property, the Integration Service does not stage source data for recovery if transformations in the pipeline always produce repeatable data.
Output is Repeatable	Relational source or transformation output that is in the same order between session runs when the order of the input data is consistent. When output is deterministic and output is repeatable, the Integration Service does not stage source data for recovery.

Warning: If you configure a transformation as repeatable and deterministic, it is your responsibility to ensure that the data is repeatable and deterministic. If you try to recover a session with transformations that do not produce the same data between the session and the recovery, the recovery process can result in corrupted data.

Default Query

For relational sources, the Integration Service generates a query for each Source Qualifier transformation when it runs a session. The default query is a SELECT statement for each source column used in the mapping. In other words, the Integration Service reads only the columns that are connected to another transformation.

The following figure shows a single source definition connected to a Source Qualifier transformation, with many source definition columns but only three connected to the final transformation:

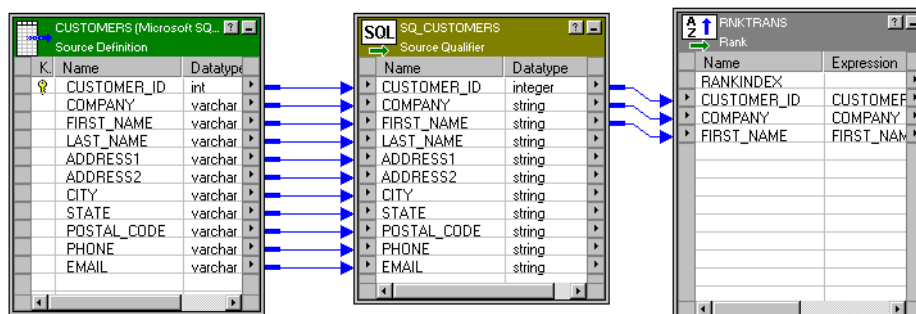

Although there are many columns in the source definition, only three columns are connected to another transformation. In this case, the Integration Service generates a default query that selects only those three columns:

```
SELECT CUSTOMERS.CUSTOMER_ID, CUSTOMERS.COMPANY, CUSTOMERS.FIRST_NAME  
  
FROM CUSTOMERS
```

If any table name or column name contains a database reserved word, you can create and maintain a file, `reswords.txt`, containing reserved words. When the Integration Service initializes a session, it searches for `reswords.txt` in the Integration Service installation directory. If the file exists, the Integration Service places quotes around matching reserved words when it executes SQL against the database. If you override the SQL, you must enclose any reserved word in quotes.

When generating the default query, the Designer delimits table and field names containing the following characters with double quotes:

```
/ + - = ~ ` ! % ^ & * ( ) [ ] { } ' ; ? , < > \ | <space>
```

Viewing the Default Query

You can view the default query in the Source Qualifier transformation.

To view the default query:

1. From the Properties tab, select SQL Query.

The SQL Editor displays the default query the Integration Service uses to select source data.

2. Click Generate SQL.
3. Click Cancel to exit.

If you do not cancel the SQL query, the Integration Service overrides the default query with the custom SQL query.

Do not connect to the source database. You only connect to the source database when you enter an SQL query that overrides the default query.

You must connect the columns in the Source Qualifier transformation to another transformation or target before you can generate the default query.

Overriding the Default Query

You can alter or override the default query in the Source Qualifier transformation by changing the default settings of the transformation properties. Do not change the list of selected ports or the order in which they appear in the query. This list must match the connected transformation output ports.

When you edit transformation properties, the Source Qualifier transformation includes these settings in the default query. However, if you enter an SQL query, the Integration Service uses only the defined SQL statement. The SQL Query overrides the User-Defined Join, Source Filter, Number of Sorted Ports, and Select Distinct settings in the Source Qualifier transformation.

Note: When you override the default SQL query, you must enclose all database reserved words in quotes.

Joining Source Data

Use one Source Qualifier transformation to join data from multiple relational tables. These tables must be accessible from the same instance or database server.

When a mapping uses related relational sources, you can join both sources in one Source Qualifier transformation. During the session, the source database performs the join before passing data to the Integration Service. This can increase performance when source tables are indexed.

Tip: Use the Joiner transformation for heterogeneous sources and to join flat files.

Default Join

When you join related tables in one Source Qualifier transformation, the Integration Service joins the tables based on the related keys in each table.

This default join is an inner equijoin, using the following syntax in the WHERE clause:

```
Source1.column_name = Source2.column_name
```

The columns in the default join must have:

- A primary key-foreign key relationship
- Matching datatypes

For example, you might see all the orders for the month, including order number, order amount, and customer name. The ORDERS table includes the order number and amount of each order, but not the customer name. To include the customer name, you need to join the ORDERS and CUSTOMERS tables. Both tables include a customer ID, so you can join the tables in one Source Qualifier transformation.

The following figure shows joining two tables with one Source Qualifier transformation:

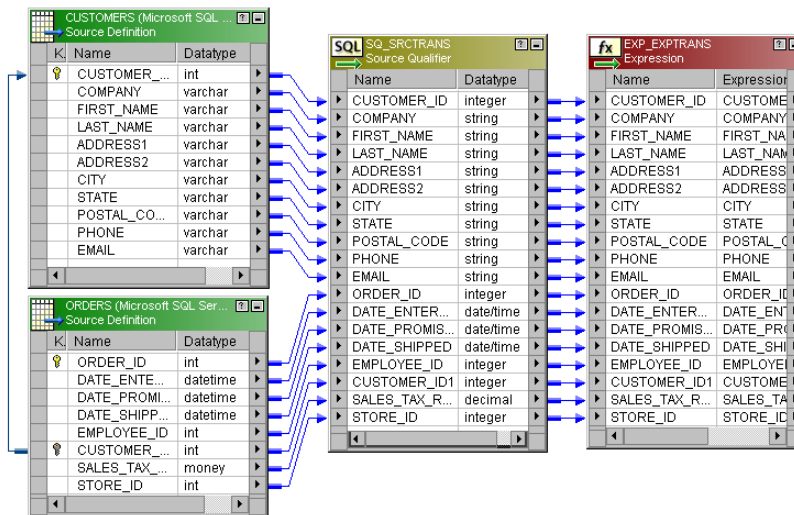

When you include multiple tables, the Integration Service generates a SELECT statement for all columns used in the mapping. In this case, the SELECT statement looks similar to the following statement:

```
SELECT CUSTOMERS.CUSTOMER_ID, CUSTOMERS.COMPANY, CUSTOMERS.FIRST_NAME,
CUSTOMERS.LAST NAME, CUSTOMERS.ADDRESS1, CUSTOMERS.ADDRESS2, CUSTOMERS.CITY,
CUSTOMERS.STATE, CUSTOMERS.POSTAL_CODE, CUSTOMERS.PHONE, CUSTOMERS.EMAIL,
ORDERS.ORDER_ID, ORDERS.DATE_ENTERED, ORDERS.DATE PROMISED, ORDERS.DATE SHIPPED,
ORDERS.EMPLOYEE_ID, ORDERS.CUSTOMER_ID, ORDERS.SALES_TAX_RATE, ORDERS.STORE_ID
FROM CUSTOMERS, ORDERS
WHERE CUSTOMERS.CUSTOMER_ID=ORDERS.CUSTOMER_ID
```

The WHERE clause is an equijoin that includes the CUSTOMER_ID from the ORDERS and CUSTOMER tables.

Custom Joins

If you need to override the default join, you can enter contents of the WHERE clause that specifies the join in the custom query. If the query performs an outer join, the Integration Service may insert the join syntax in the WHERE clause or the FROM clause, depending on the database syntax.

You might need to override the default join under the following circumstances:

- Columns do not have a primary key-foreign key relationship.
- The datatypes of columns used for the join do not match.
- You want to specify a different type of join, such as an outer join.

Heterogeneous Joins

To perform a heterogeneous join, use the Joiner transformation. Use the Joiner transformation when you need to join the following types of sources:

- Join data from different source databases
- Join data from different flat file systems
- Join relational sources and flat files

Creating Key Relationships

You can join tables in the Source Qualifier transformation if the tables have primary key-foreign key relationships. However, you can create primary key-foreign key relationships in the Source Analyzer by linking matching columns in different tables. These columns do not have to be keys, but they should be included in the index for each table.

Tip: If the source table has more than 1,000 rows, you can increase performance by indexing the primary key-foreign keys. If the source table has fewer than 1,000 rows, you might decrease performance if you index the primary key-foreign keys.

For example, the corporate office for a retail chain wants to extract payments received based on orders. The ORDERS and PAYMENTS tables do not share primary and foreign keys. Both tables, however, include a DATE_SHIPPED column. You can create a primary key-foreign key relationship in the metadata in the Source Analyzer.

Note, the two tables are not linked. Therefore, the Designer does not recognize the relationship on the DATE_SHIPPED columns.

You create a relationship between the ORDERS and PAYMENTS tables by linking the DATE_SHIPPED columns. The Designer adds primary and foreign keys to the DATE_SHIPPED columns in the ORDERS and PAYMENTS table definitions.

The following figure shows the DATE_SHIPPED relationship between two tables:

K	Name	Datatype
	ORDER_ID	int
	DATE_ENTER...	datetime
	DATE_PROMI...	datetime
	DATE_SHIPPED	datetime
	EMPLOYEE_ID	int
	CUSTOMER_ID	int
	SALES_TAX_R...	money
	STORE_ID	int

K	Name	Datatype
	VOUCHER_NO	int
	VOUCHER_DA...	datetime
	DATE_SHIPPED	datetime
	VOUCHER_TOT	decimal

If you do not connect the columns, the Designer does not recognize the relationships.

The primary key-foreign key relationships exist in the metadata only. You do not need to generate SQL or alter the source tables.

Once the key relationships exist, use a Source Qualifier transformation to join the two tables. The default join is based on DATE_SHIPPED.

Adding an SQL Query

The Source Qualifier transformation provides the SQL Query option to override the default query. You can enter an SQL statement supported by the source database. Before entering the query, connect all the input and output ports you want to use in the mapping.

When you edit the SQL Query, you can generate and edit the default query. When the Designer generates the default query, it incorporates all other configured options, such as a filter or number of sorted ports. The resulting query overrides all other options you might subsequently configure in the transformation.

You can use a parameter or variable as the SQL query or include parameters and variables within the query. When including a string mapping parameter or variable, use a string identifier appropriate to the source system. For most databases, you need to enclose the name of a string parameter or variable in single quotes.

When you include a datetime value or a datetime mapping parameter or variable in the SQL query, change the date format to match the format used by the source. The Integration Service converts a datetime value to a string based on the source system.

Use the following rules and guidelines when you enter a custom SQL query:

- The SELECT statement must list the port names in the order in which they appear in the transformation.
- If the source is Microsoft SQL Server, the number of columns in the SELECT statement in the query must match the number of ports in the Source Qualifier transformation. Otherwise, the session might fail with the following error: `SQL Error [FnName: Fetch Optimize -- [Informatica][ODBC SQL Server Wire Protocol driver] Number of bound columns exceeds the number of result columns.]`.

When you override the default SQL query for a session configured for pushdown optimization, the Integration Service creates a view to represent the SQL override. It then runs an SQL query against this view to push the transformation logic to the database.

If you edit the SQL query, you must enclose all database reserved words in quotes.

1. Open the Source Qualifier transformation, and click the Properties tab.
2. Click the Open button in the SQL Query field.

The SQL Editor dialog box appears.

3. Click Generate SQL.

The Designer displays the default query it generates when querying rows from all sources included in the Source Qualifier transformation.

4. Enter a query in the space where the default query appears.

Every column name must be qualified by the name of the table, view, or synonym in which it appears. For example, if you want to include the ORDER_ID column from the ORDERS table, enter `ORDERS.ORDER_ID`. You can double-click column names appearing in the Ports window to avoid typing the name of every column.

You can use a parameter or variable as the query, or you can include parameters and variables in the query.

Enclose string mapping parameters and variables in string identifiers. Alter the date format for datetime mapping parameters and variables when necessary.

5. Select the ODBC data source containing the sources included in the query.
6. Enter the user name and password to connect to this database.

The Use Kerberos Authentication option indicates that the database in the connection runs on a network that uses Kerberos authentication. If this option is selected, you cannot enter the user name and password. The connection uses the credentials of the user account logged in to the machine where the Designer runs.

7. Click Validate.

The Designer runs the query and reports whether its syntax was correct.

8. Click OK to return to the Edit Transformations dialog box. Click OK again to return to the Designer.

Tip: You can resize the Expression Editor. Expand the dialog box by dragging from the borders. The Designer saves the new size for the dialog box as a client setting.

Entering a User-Defined Join

Entering a user-defined join is similar to entering a custom SQL query. However, you only enter the contents of the WHERE clause, not the entire query. When you perform an outer join, the Integration Service may insert the join syntax in the WHERE clause or the FROM clause of the query, depending on the database syntax.

When you add a user-defined join, the Source Qualifier transformation includes the setting in the default SQL query. However, if you modify the default query after adding a user-defined join, the Integration Service uses only the query defined in the SQL Query property of the Source Qualifier transformation.

You can use a parameter or variable as the user-defined join or include parameters and variables within the join. When including a string mapping parameter or variable, use a string identifier appropriate to the source system. For most databases, you need to enclose the name of a string parameter or variable in single quotes.

When you include a datetime parameter or variable, you might need to change the date format to match the format used by the source. The Integration Service converts a datetime parameter and variable to a string based on the source system.

To create a user-defined join:

1. Create a Source Qualifier transformation containing data from multiple sources or associated sources.
2. Open the Source Qualifier transformation, and click the Properties tab.
3. Click the Open button in the User Defined Join field.

The SQL Editor dialog box appears.

4. Enter the syntax for the join.

Do not enter the keyword WHERE at the beginning of the join. The Integration Service adds this keyword when it queries rows.

Enclose string mapping parameters and variables in string identifiers. Alter the date format for datetime mapping parameters and variables when necessary.

5. Click OK to return to the Edit Transformations dialog box, and then click OK to return to the Designer.

Outer Join Support

Use the Source Qualifier and the Application Source Qualifier transformations to perform an outer join of two sources in the same database. When the Integration Service performs an outer join, it returns all rows from one source table and rows from the second source table that match the join condition.

Use an outer join when you want to join two tables and return all rows from one of the tables. For example, you might perform an outer join when you want to join a table of registered customers with a monthly purchases table to determine registered customer activity. Using an outer join, you can join the registered customer table with the monthly purchases table and return all rows in the registered customer table, including customers who did not make purchases in the last month. If you perform a normal join, the Integration Service returns only registered customers who made purchases during the month, and only purchases made by registered customers.

With an outer join, you can generate the same results as a master outer or detail outer join in the Joiner transformation. However, when you use an outer join, you reduce the number of rows in the data flow. This can improve performance.

The Integration Service supports two kinds of outer joins:

- **Left.** Integration Service returns all rows for the table to the left of the join syntax and the rows from both tables that meet the join condition.
- **Right.** Integration Service returns all rows for the table to the right of the join syntax and the rows from both tables that meet the join condition.

Note: Use outer joins in nested query statements when you override the default query.

Informatica Join Syntax

When you enter join syntax, use the Informatica or database-specific join syntax. When you use the Informatica join syntax, the Integration Service translates the syntax and passes it to the source database during the session.

Note: Always use database-specific syntax for join conditions.

When you use Informatica join syntax, enclose the entire join statement in braces ({Informatica syntax}). When you use database syntax, enter syntax supported by the source database without braces.

When using Informatica join syntax, use table names to prefix column names. For example, if you have a column named FIRST_NAME in the REG_CUSTOMER table, enter "REG_CUSTOMER.FIRST_NAME" in the join syntax. Also, when using an alias for a table name, use the alias within the Informatica join syntax to ensure the Integration Service recognizes the alias.

The following table lists the join syntax you can enter, in different locations for different Source Qualifier transformations, when you create an outer join:

Transformation	Transformation Setting	Description
Source Qualifier Transformation	User-Defined Join	Create a join override. The Integration Service appends the join override to the WHERE or FROM clause of the default query.
Source Qualifier Transformation	SQL Query	Enter join syntax immediately after the WHERE in the default query.

Transformation	Transformation Setting	Description
Application Source Qualifier Transformation	Join Override	Create a join override. The Integration Service appends the join override to the WHERE clause of the default query.
Application Source Qualifier Transformation	Extract Override	Enter join syntax immediately after the WHERE in the default query.

You can combine left outer and right outer joins with normal joins in a single source qualifier. Use multiple normal joins and multiple left outer joins.

When you combine joins, enter them in the following order:

1. Normal
2. Left outer
3. Right outer

Note: Some databases limit you to using one right outer join.

Normal Join Syntax

You can create a normal join using the join condition in a source qualifier. However, if you are creating an outer join, you need to override the default join to perform an outer join. As a result, you need to include the normal join in the join override. When incorporating a normal join in the join override, list the normal join before outer joins. You can enter multiple normal joins in the join override.

To create a normal join, use the following syntax:

```
{ source1 INNER JOIN source2 on join_condition }
```

The following table displays the syntax for Normal Joins in a Join Override:

Syntax	Description
<i>source1</i>	Source table name. The Integration Service returns rows from this table that match the join condition.
<i>source2</i>	Source table name. The Integration Service returns rows from this table that match the join condition.
<i>join_condition</i>	Condition for the join. Use syntax supported by the source database. You can combine multiple join conditions with the AND operator.

For example, you have a REG_CUSTOMER table with data for registered customers:

CUST_ID	FIRST_NAME	LAST_NAME
00001	Marvin	Chi
00002	Dinah	Jones
00003	John	Bowden
00004	J.	Marks

The PURCHASES table, refreshed monthly, contains the following data:

TRANSACTION_NO	CUST_ID	DATE	AMOUNT
06-2000-0001	00002	6/3/2000	55.79
06-2000-0002	00002	6/10/2000	104.45
06-2000-0003	00001	6/10/2000	255.56
06-2000-0004	00004	6/15/2000	534.95
06-2000-0005	00002	6/21/2000	98.65
06-2000-0006	NULL	6/23/2000	155.65
06-2000-0007	NULL	6/24/2000	325.45

To return rows displaying customer names for each transaction in the month of June, use the following syntax:

```
{ REG_CUSTOMER INNER JOIN PURCHASES on REG_CUSTOMER.CUST_ID = PURCHASES.CUST_ID }
```

The Integration Service returns the following data:

CUST_ID	DATE	AMOUNT	FIRST_NAME	LAST_NAME
00002	6/3/2000	55.79	Dinah	Jones
00002	6/10/2000	104.45	Dinah	Jones
00001	6/10/2000	255.56	Marvin	Chi
00004	6/15/2000	534.95	J.	Marks
00002	6/21/2000	98.65	Dinah	Jones

The Integration Service returns rows with matching customer IDs. It does not include customers who made no purchases in June. It also does not include purchases made by non-registered customers.

Left Outer Join Syntax

You can create a left outer join with a join override. You can enter multiple left outer joins in a single join override. When using left outer joins with other joins, list all left outer joins together, after any normal joins in the statement.

To create a left outer join, use the following syntax:

```
{ source1 LEFT OUTER JOIN source2 on join_condition }
```

The following tables displays syntax for left outer joins in a join override:

Syntax	Description
<i>source1</i>	Source table name. With a left outer join, the Integration Service returns all rows in this table.
<i>source2</i>	Source table name. The Integration Service returns rows from this table that match the join condition.
<i>join_condition</i>	Condition for the join. Use syntax supported by the source database. You can combine multiple join conditions with the AND operator.

For example, using the same REG_CUSTOMER and PURCHASES tables described in [“Normal Join Syntax” on page 393](#), you can determine how many customers bought something in June with the following join override:

```
{ REG_CUSTOMER LEFT OUTER JOIN PURCHASES on REG_CUSTOMER.CUST_ID = PURCHASES.CUST_ID }
```

The Integration Service returns the following data:

CUST_ID	FIRST_NAME	LAST_NAME	DATE	AMOUNT
00001	Marvin	Chi	6/10/2000	255.56
00002	Dinah	Jones	6/3/2000	55.79
00003	John	Bowden	NULL	NULL
00004	J.	Marks	6/15/2000	534.95
00002	Dinah	Jones	6/10/2000	104.45
00002	Dinah	Jones	6/21/2000	98.65

The Integration Service returns all registered customers in the REG_CUSTOMERS table, using null values for the customer who made no purchases in June. It does not include purchases made by non-registered customers.

Use multiple join conditions to determine how many registered customers spent more than \$100.00 in a single purchase in June:

```
{REG_CUSTOMER LEFT OUTER JOIN PURCHASES on (REG_CUSTOMER.CUST_ID = PURCHASES.CUST_ID AND PURCHASES.AMOUNT > 100.00) }
```

The Integration Service returns the following data:

CUST_ID	FIRST_NAME	LAST_NAME	DATE	AMOUNT
00001	Marvin	Chi	6/10/2000	255.56
00002	Dinah	Jones	6/10/2000	104.45
00003	John	Bowden	NULL	NULL
00004	J.	Marks	6/15/2000	534.95

You might use multiple left outer joins if you want to incorporate information about returns during the same time period. For example, the RETURNS table contains the following data:

CUST_ID	CUST_ID	RETURN
00002	6/10/2000	55.79
00002	6/21/2000	104.45

To determine how many customers made purchases and returns for the month of June, use two left outer joins:

```
{ REG_CUSTOMER LEFT OUTER JOIN PURCHASES on REG_CUSTOMER.CUST_ID = PURCHASES.CUST_ID
LEFT OUTER JOIN RETURNS on REG_CUSTOMER.CUST_ID = RETURNS.CUST_ID }
```

The Integration Service returns the following data:

CUST_ID	FIRST_NAME	LAST_NAME	DATE	AMOUNT	RET_DATE	RETURN
00001	Marvin	Chi	6/10/2000	255.56	NULL	NULL
00002	Dinah	Jones	6/3/2000	55.79	NULL	NULL
00003	John	Bowden	NULL	NULL	NULL	NULL
00004	J.	Marks	6/15/2000	534.95	NULL	NULL
00002	Dinah	Jones	6/10/2000	104.45	NULL	NULL
00002	Dinah	Jones	6/21/2000	98.65	NULL	NULL
00002	Dinah	Jones	NULL	NULL	6/10/2000	55.79
00002	Dinah	Jones	NULL	NULL	6/21/2000	104.45

The Integration Service uses NULLs for missing values.

Right Outer Join Syntax

You can create a right outer join with a join override. The right outer join returns the same results as a left outer join if you reverse the order of the tables in the join syntax. Use only one right outer join in a join override. If you want to create more than one right outer join, try reversing the order of the source tables and changing the join types to left outer joins.

When you use a right outer join with other joins, enter the right outer join at the end of the join override.

To create a right outer join, use the following syntax:

```
{ source1 RIGHT OUTER JOIN source2 on join_condition }
```

The following table displays syntax for a right outer join in a join override:

Syntax	Description
<i>source1</i>	Source table name. The Integration Service returns rows from this table that match the join condition.
<i>source2</i>	Source table name. With a right outer join, the Integration Service returns all rows in this table.
<i>join_condition</i>	Condition for the join. Use syntax supported by the source database. You can combine multiple join conditions with the AND operator.

You might use a right outer join with a left outer join to join and return all data from both tables, simulating a full outer join. For example, you can extract all registered customers and all purchases for the month of June with the following join override:

```
{REG_CUSTOMER LEFT OUTER JOIN PURCHASES on REG_CUSTOMER.CUST_ID = PURCHASES.CUST_ID
RIGHT OUTER JOIN PURCHASES on REG_CUSTOMER.CUST_ID = PURCHASES.CUST_ID }
```

The Integration Service returns the following data:

CUST_ID	FIRST_NAME	LAST_NAME	TRANSACTION_NO	DATE	AMOUNT
00001	Marvin	Chi	06-2000-0003	6/10/2000	255.56
00002	Dinah	Jones	06-2000-0001	6/3/2000	55.79
00003	John	Bowden	NULL	NULL	NULL
00004	J.	Marks	06-2000-0004	6/15/2000	534.95
00002	Dinah	Jones	06-2000-0002	6/10/2000	104.45
00002	Dinah	Jones	06-2000-0005	6/21/2000	98.65
NULL	NULL	NULL	06-2000-0006	6/23/2000	155.65
NULL	NULL	NULL	06-2000-0007	6/24/2000	325.45

Creating an Outer Join

You can enter an outer join as a join override or as part of an override of the default query.

When you create a join override, the Designer appends the join override to the WHERE clause of the default query. During the session, the Integration Service translates the Informatica join syntax and includes it in the default query used to extract source data. When possible, enter a join override instead of overriding the default query.

When you override the default query, enter the join syntax in the WHERE clause of the default query. During the session, the Integration Service translates Informatica join syntax and then uses the query to extract source data. If you make changes to the transformation after creating the override, the Integration Service ignores the changes. Therefore, when possible, enter outer join syntax as a join override.

Creating an Outer Join as a Join Override

To create an outer join as a join override:

1. Open the Source Qualifier transformation, and click the Properties tab.

2. In a Source Qualifier transformation, click the button in the User Defined Join field.
In an Application Source Qualifier transformation, click the button in the Join Override field.
3. Enter the syntax for the join.
Do not enter WHERE at the beginning of the join. The Integration Service adds this when querying rows.
Enclose Informatica join syntax in braces ({ }).
When using an alias for a table and the Informatica join syntax, use the alias within the Informatica join syntax.
Use table names to prefix columns names, for example, "table.column".
Use join conditions supported by the source database.
When entering multiple joins, group joins together by type, and then list them in the following order: normal, left outer, right outer. Include only one right outer join per nested query.
Select port names from the Ports tab to ensure accuracy.
4. Click OK.

Creating an Outer Join as an Extract Override

To create an outer join as an extract override:

1. After connecting the input and output ports for the Application Source Qualifier transformation, double-click the title bar of the transformation and select the Properties tab.
2. In an Application Source Qualifier transformation, click the button in the Extract Override field.
3. Click Generate SQL.
4. Enter the syntax for the join in the WHERE clause immediately after the WHERE.
Enclose Informatica join syntax in braces ({ }).
When using an alias for a table and the Informatica join syntax, use the alias within the Informatica join syntax.
Use table names to prefix columns names, for example, "table.column".
Use join conditions supported by the source database.
When entering multiple joins, group joins together by type, and then list them in the following order: normal, left outer, right outer. Include only one right outer join per nested query.
Select port names from the Ports tab to ensure accuracy.
5. Click OK.

Common Database Syntax Restrictions

Different databases have different restrictions on outer join syntax. Consider the following restrictions when you create outer joins:

- Do not combine join conditions with the OR operator in the ON clause of outer join syntax.
- Do not use the IN operator to compare columns in the ON clause of outer join syntax.
- Do not compare a column to a subquery in the ON clause of outer join syntax.
- When combining two or more outer joins, do not use the same table as the inner table of more than one outer join. For example, do not use either of the following outer joins:

```
{ TABLE1 LEFT OUTER JOIN TABLE2 ON TABLE1.COLUMNA = TABLE2.COLUMNA TABLE3 LEFT OUTER
JOIN TABLE2 ON TABLE3.COLUMNB = TABLE2.COLUMNB }
```

```
{ TABLE1 LEFT OUTER JOIN TABLE2 ON TABLE1.COLUMNA = TABLE2.COLUMNA TABLE2 RIGHT OUTER JOIN TABLE3 ON TABLE2.COLUMNB = TABLE3.COLUMNB}
```

- Do not use both tables of an outer join in a regular join condition. For example, do not use the following join condition:

```
{ TABLE1 LEFT OUTER JOIN TABLE2 ON TABLE1.COLUMNA = TABLE2.COLUMNA WHERE TABLE1.COLUMNB = TABLE2.COLUMNC}
```

However, use both tables in a filter condition, like the following:

```
{ TABLE1 LEFT OUTER JOIN TABLE2 ON TABLE1.COLUMNA = TABLE2.COLUMNA WHERE TABLE1.COLUMNB = 32 AND TABLE2.COLUMNC > 0}
```

Note: Entering a condition in the ON clause might return different results from entering the same condition in the WHERE clause.

- When using an alias for a table, use the alias to prefix columns in the table. For example, if you call the REG_CUSTOMER table C, when referencing the column FIRST_NAME, use "C.FIRST_NAME."

Entering a Source Filter

You can enter a source filter to reduce the number of rows the Integration Service queries. If you include the string 'WHERE' or large objects in the source filter, the Integration Service fails the session.

If you add a source filter to the Source Qualifier transformation in the mapping, the default SQL query contains the filter condition. If, however, you modify the default query after adding a source filter, the Integration Service uses only the query defined in the SQL query portion of the Source Qualifier transformation.

You can use a parameter or variable as the source filter or include parameters and variables within the source filter. When including a string mapping parameter or variable, use a string identifier appropriate to the source system. For most databases, you need to enclose the name of a string parameter or variable in single quotes.

When you include a datetime parameter or variable, you might need to change the date format to match the format used by the source. The Integration Service converts a datetime parameter and variable to a string based on the source system.

Note: When you enter an SQL query in the session properties, you override the filter condition and the SQL query at the mapping level.

To enter a source filter:

1. In the Mapping Designer, open a Source Qualifier transformation.
The Edit Transformations dialog box appears.
2. Select the Properties tab.
3. Click the Open button in the Source Filter field.
4. In the SQL Editor dialog box, enter the filter.
Include the table name and port name. Do not include the keyword WHERE in the filter.
Enclose string mapping parameters and variables in string identifiers. Alter the date format for datetime mapping parameters and variables when necessary.
5. Click OK.

Using Sorted Ports

When you use sorted ports, the Integration Service adds the ports to the ORDER BY clause in the default query. The Integration Service adds the configured number of ports, starting at the top of the Source Qualifier transformation. If a subset of ports is connected downstream, the default query only includes the subset of ports. The sorted ports are applied on the connected ports rather than the ports that start at the top of the Source Qualifier transformation.

You might use sorted ports to improve performance when you include any of the following transformations in a mapping:

- **Aggregator.** When you configure an Aggregator transformation for sorted input, you can send sorted data by using sorted ports. The group by ports in the Aggregator transformation must match the order of the sorted ports in the Source Qualifier transformation.
- **Joiner.** When you configure a Joiner transformation for sorted input, you can send sorted data by using sorted ports. Configure the order of the sorted ports the same in each Source Qualifier transformation.

Note: You can also use the Sorter transformation to sort relational and flat file data before Aggregator and Joiner transformations.

Use sorted ports for relational sources only. When using sorted ports, the sort order of the source database must match the sort order configured for the session. The Integration Service creates the SQL query used to extract source data, including the ORDER BY clause for sorted ports. The database server performs the query and passes the resulting data to the Integration Service. To ensure data is sorted as the Integration Service requires, the database sort order must be the same as the user-defined session sort order.

When you configure the Integration Service for data code page validation and run a workflow in Unicode data movement mode, the Integration Service uses the selected sort order to sort character data.

When you configure the Integration Service for relaxed data code page validation, the Integration Service uses the selected sort order to sort all character data that falls in the language range of the selected sort order. The Integration Service sorts all character data outside the language range of the selected sort order according to standard Unicode sort ordering.

When the Integration Service runs in ASCII mode, it ignores this setting and sorts all character data using a binary sort order. The default sort order depends on the code page of the Integration Service.

The Source Qualifier transformation includes the number of sorted ports in the default SQL query. However, if you modify the default query after choosing the Number of Sorted Ports, the Integration Service uses only the query defined in the SQL Query property.

To use sorted ports:

1. In the Mapping Designer, open a Source Qualifier transformation, and click the Properties tab.
2. Click in Number of Sorted Ports and enter the number of ports you want to sort.

The Integration Service adds the configured number of columns to an ORDER BY clause, starting from the top of the Source Qualifier transformation.

The source database sort order must correspond to the session sort order.

Tip: Sybase supports a maximum of 16 columns in an ORDER BY clause. If the source is Sybase, do not sort more than 16 columns.

3. Click OK.

Select Distinct

If you want the Integration Service to select unique values from a source, use the Select Distinct option. You might use this feature to extract unique customer IDs from a table listing total sales. Using Select Distinct filters out unnecessary data earlier in the data flow, which might improve performance.

By default, the Designer generates a SELECT statement. If you choose Select Distinct, the Source Qualifier transformation includes the setting in the default SQL query.

For example, in the Source Qualifier transformation in [“Joining Source Data” on page 388](#), you enable the Select Distinct option. The Designer adds SELECT DISTINCT to the default query as follows:

```
SELECT DISTINCT CUSTOMERS.CUSTOMER_ID, CUSTOMERS.COMPANY, CUSTOMERS.FIRST_NAME,
CUSTOMERS.LAST_NAME, CUSTOMERS.ADDRESS1, CUSTOMERS.ADDRESS2, CUSTOMERS.CITY,
CUSTOMERS.STATE, CUSTOMERS.POSTAL_CODE, CUSTOMERS.EMAIL, ORDERS.ORDER_ID,
ORDERS.DATE_ENTERED, ORDERS.DATE_PROMISED, ORDERS.DATE_SHIPPED, ORDERS.EMPLOYEE_ID,
ORDERS.CUSTOMER_ID, ORDERS.SALES_TAX_RATE, ORDERS.STORE_ID
FROM
CUSTOMERS, ORDERS
WHERE
CUSTOMERS.CUSTOMER_ID=ORDERS.CUSTOMER_ID
```

However, if you modify the default query after choosing Select Distinct, the Integration Service uses only the query defined in the SQL Query property. In other words, the SQL Query overrides the Select Distinct setting.

To use Select Distinct:

1. Open the Source Qualifier transformation in the mapping, and click on the Properties tab.
2. Check Select Distinct, and Click OK.

Overriding Select Distinct in the Session

You can override the transformation level option to Select Distinct when you configure the session in the Workflow Manager.

To override the Select Distinct option:

1. In the Workflow Manager, open the Session task, and click the Mapping tab.
2. Click the Transformations view, and click the Source Qualifier transformation under the Sources node.
3. In the Properties settings, enable Select Distinct, and click OK.

Adding Pre- and Post-Session SQL Commands

You can add pre- and post-session SQL commands on the Properties tab in the Source Qualifier transformation. You might want to use pre-session SQL to write a timestamp row to the source table when a session begins.

The Integration Service runs pre-session SQL commands against the source database before it reads the source. It runs post-session SQL commands against the source database after it writes to the target.

You can override the SQL commands in the Transformations view on the Mapping tab in the session properties. You can also configure the Integration Service to stop or continue when it encounters errors running pre- or post-session SQL commands.

Use the following guidelines when you enter pre- and post-session SQL commands in the Source Qualifier transformation:

- Use any command that is valid for the database type. However, the Integration Service does not allow nested comments, even though the database might.
- You can use parameters and variables in source pre- and post-session SQL commands, or you can use a parameter or variable as the command. Use any parameter or variable type that you can define in the parameter file.
- Use a semicolon (;) to separate multiple statements. The Integration Service issues a commit after each statement.
- The Integration Service ignores semicolons within /*...*/.
- If you need to use a semicolon outside of comments, you can escape it with a backslash (\). When you escape the semicolon, the Integration Service ignores the backslash, and it does not use the semicolon as a statement separator.
- The Designer does not validate the SQL.

Note: You can also enter pre- and post-session SQL commands on the Properties tab of the target instance in a mapping.

Creating a Source Qualifier Transformation

You can configure the Designer to create a Source Qualifier transformation by default when you drag a source into a mapping, or you can create a Source Qualifier transformation manually.

Creating a Source Qualifier Transformation Manually

You can manually create a Source Qualifier transformation in the Mapping Designer.

To create a Source Qualifier transformation manually:

1. In the Mapping Designer, click Transformation > Create.
2. Enter a name for the transformation, and click Create.
3. Select a source, and click OK.
4. Click Done.

Configuring Source Qualifier Transformation Options

After you create the Source Qualifier transformation, you can configure several options.

To configure a Source Qualifier transformation:

1. In the Designer, open a mapping.
2. Double-click the title bar of the Source Qualifier transformation.
3. In the Edit Transformations dialog box, click Rename, enter a descriptive name for the transformation, and click OK.

The naming convention for Source Qualifier transformations is *SQ_TransformationName*, such as *SQ_AllSources*.

4. Click the Properties tab.

5. Enter the Source Qualifier transformation properties.
6. Click the Sources tab and indicate any associated source definitions you want to define for this transformation.
Identify associated sources only when you need to join data from multiple databases or flat file systems.
7. Click OK.

Troubleshooting Source Qualifier Transformations

I cannot perform a drag and drop operation, such as connecting ports.

Review the error message on the status bar for details.

I cannot connect a source definition to a target definition.

You cannot directly connect sources to targets. Instead, you need to connect them through a Source Qualifier transformation for relational and flat file sources, or through a Normalizer transformation for COBOL sources.

I cannot connect multiple sources to one target.

The Designer does not allow you to connect multiple Source Qualifier transformations to a single target. There are two workarounds:

- **Reuse targets.** Since target definitions are reusable, you can add the same target to the mapping multiple times. Then connect each Source Qualifier transformation to each target.
- **Join the sources in a Source Qualifier transformation.** Then remove the WHERE clause from the SQL query.

The source has QNAN (not a number) values in some columns, but the target shows 1.#QNAN.

Operating systems have different string representations of NaN. The Integration Service converts QNAN values to 1.#QNAN on Win64EMT platforms. 1.#QNAN is a valid representation of QNAN.

I entered a custom query, but it is not working when I run the workflow containing the session.

Be sure to test this setting for the Source Qualifier transformation before you run the workflow. Return to the Source Qualifier transformation and reopen the dialog box in which you entered the custom query. You can connect to a database and click the Validate button to test the SQL. The Designer displays any errors. Review the session log file if you need further information.

The most common reason a session fails is because the database login in both the session and Source Qualifier transformation is not the table owner. You need to specify the table owner in the session and when you generate the SQL Query in the Source Qualifier transformation.

You can test the SQL Query by cutting and pasting it into the database client tool (such as Oracle Net) to see if it returns an error.

I used a mapping variable in a source filter and now the session fails.

Try testing the query by generating and validating the SQL in the Source Qualifier transformation. If the variable or parameter is a string, you probably need to enclose it in single quotes. If it is a datetime variable or parameter, you might need to change its format for the source system.

CHAPTER 26

SQL Transformation

This chapter includes the following topics:

- [SQL Transformation Overview, 405](#)
- [Script Mode, 406](#)
- [Query Mode, 407](#)
- [Connecting to Databases, 412](#)
- [Session Processing, 416](#)
- [Input Row to Output Row Cardinality, 419](#)
- [SQL Transformation Properties, 423](#)
- [SQL Statements, 426](#)
- [Creating an SQL Transformation, 427](#)

SQL Transformation Overview

The SQL transformation processes SQL queries midstream in a pipeline. The SQL transformation can be an active or passive transformation. You can insert, delete, update, and retrieve rows from a database. You can pass the database connection information to the SQL transformation as input data at run time. The transformation processes external SQL scripts or SQL queries that you create in an SQL editor. The SQL transformation processes the query and returns rows and database errors.

For example, you might need to create database tables before adding new transactions. You can create an SQL transformation to create the tables in a workflow. The SQL transformation returns database errors in an output port. You can configure another workflow to run if the SQL transformation returns no errors.

When you create an SQL transformation, you configure the following options:

- **Mode.** The SQL transformation runs in one of the following modes:
 - **Script mode.** The SQL transformation runs ANSI SQL scripts that are externally located. You pass a script name to the transformation with each input row. The SQL transformation outputs one row for each input row.
 - **Query mode.** The SQL transformation executes a query that you define in a query editor. You can pass strings or parameters to the query to define dynamic queries or change the selection parameters. You can output multiple rows when the query has a SELECT statement.
- **Passive or active transformation.** The SQL transformation is an active transformation by default. You can configure it as a passive transformation when you create the transformation.
- **Database type.** The type of database the SQL transformation connects to.

- **Connection type.** Pass database connection information to the SQL transformation or use a connection object.

Script Mode

An SQL transformation running in script mode runs SQL scripts from text files. You pass each script file name from the source to the SQL transformation ScriptName port. The script file name contains the complete path to the script file.

When you configure the transformation to run in script mode, you create a passive transformation. The transformation returns one row for each input row. The output row contains results of the query and any database error.

When the SQL transformation runs in script mode, the query statement and query data do not change. When you need to run different queries in script mode, you pass the scripts in the source data. Use script mode to run data definition queries such as creating or dropping tables.

When you configure an SQL transformation to run in script mode, the Designer adds the ScriptName input port to the transformation. When you create a mapping, you connect the ScriptName port to a port that contains the name of a script to execute for each row. You can execute a different SQL script for each input row. The Designer creates default ports that return information about query results.

An SQL transformation configured for script mode has the following default ports:

Port	Type	Description
ScriptName	Input	Receives the name of the script to execute for the current row.
ScriptResult	Output	Returns PASSED if the script execution succeeds for the row. Otherwise contains FAILED.
ScriptError	Output	Returns errors that occur when a script fails for a row.

Example

You need to create order and inventory tables before adding new data to the tables. You can create an SQL script to create the tables and configure an SQL transformation to run the script.

You create a file called create_order_inventory.txt that contains the SQL statements to create the tables.

The following mapping shows how to pass the script name to the SQL transformation:

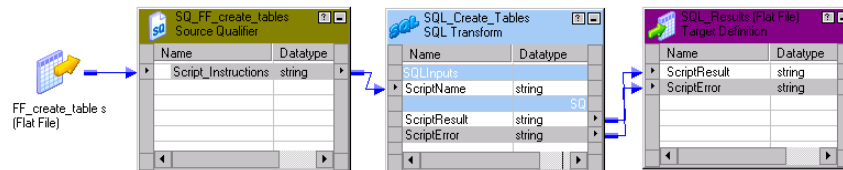

The Integration Service reads a row from the source. The source row contains the SQL script file name and path:

```
C:\81\server\shared\SrcFiles\create_order_inventory.txt
```

The transformation receives the file name in the ScriptName port. The Integration Service locates the script file and parses the script. It creates an SQL procedure and sends it to the database to process. The database validates the SQL and executes the query.

The SQL transformation returns the ScriptResults and ScriptError. If the script executes successfully, the ScriptResult output port returns PASSED. Otherwise, the ScriptResult port returns FAILED. When the ScriptResult is FAILED, the SQL transformation returns error messages in the ScriptError port. The SQL transformation returns one row for each input row it receives.

Rules and Guidelines for Script Mode

Use the following rules and guidelines for an SQL transformation that runs in script mode:

- You can use a static or dynamic database connection with script mode.
- To include multiple query statements in a script, you can separate them with a semicolon.
- You can use mapping variables or parameters in the script file name.
- The script code page defaults to the locale of the operating system. You can change the locale of the script.
- The script file must be accessible by the Integration Service. The Integration Service must have read permissions on the directory that contains the script. If the Integration Service uses operating system profiles, the operating system user of the operating system profile must have read permissions on the directory that contains the script.
- The Integration Service ignores the output of any SELECT statement you include in the SQL script. The SQL transformation in script mode does not output more than one row of data for each input row.
- You cannot use scripting languages such as Oracle PL/SQL or Microsoft/Sybase T-SQL in the script.
- You cannot use nested scripts where the SQL script calls another SQL script.
- A script cannot accept run-time arguments.

Query Mode

When an SQL transformation runs in query mode, it executes an SQL query that you define in the transformation. You pass strings or parameters to the query from the transformation input ports to change the query statement or the query data.

When you configure the SQL transformation to run in query mode, you create an active transformation. The transformation can return multiple rows for each input row.

Create queries in the SQL transformation SQL Editor. To create a query, type the query statement in the SQL Editor main window. The SQL Editor provides a list of the transformation ports that you can reference in the query. You can double-click a port name to add it as a query parameter.

When you create a query, the SQL Editor validates the port names in the query. It also verifies that the ports you use for string substitution are string datatypes. The SQL Editor does not validate the syntax of the SQL query.

You can create the following types of SQL queries in the SQL transformation:

- **Static SQL query.** The query statement does not change, but you can use query parameters to change the data. The Integration Service prepares the query once and runs the query for all input rows.
- **Dynamic SQL query.** You can change the query statements and the data. The Integration Service prepares a query for each input row.

When you create a static query, the Integration Service prepares the SQL procedure once and executes it for each row. When you create a dynamic query, the Integration Service prepares the SQL for each input row. You can optimize performance by creating static queries.

Using Static SQL Queries

Create a static SQL query when you need to run the same query statements for each input row, but you want to change the data in the query for each input row. When you create a static SQL query, you use parameter binding in the SQL Editor to define parameters for query data.

To change the data in the query, configure query parameters and bind them to input ports in the transformation. When you bind a parameter to an input port, you identify the port by name in the query. The SQL Editor encloses the name in question marks (?). The query data changes based on the value of the data in the input port.

The SQL transformation input ports receive the data for the data values in the query, or the values in the WHERE clause of the query.

The following static queries use parameter binding:

```
DELETE FROM Employee WHERE Dept = ?Dept?
INSERT INTO Employee(Employee_ID, Dept) VALUES (?Employee_ID?, ?Dept?)
UPDATE Employee SET Dept = ?Dept? WHERE Employee_ID > 100
```

The following static SQL query has query parameters that bind to the Employee_ID and Dept input ports of an SQL transformation:

```
SELECT Name, Address FROM Employees WHERE Employee_Num =?Employee_ID? and Dept = ?Dept?
```

The source might have the following rows:

Employee_ID	Dept
100	Products
123	HR
130	Accounting

The Integration Service generates the following query statements from the rows:

```
SELECT Name, Address FROM Employees WHERE Employee_ID = '100' and DEPT = 'Products'
SELECT Name, Address FROM Employees WHERE Employee_ID = '123' and DEPT = 'HR'
SELECT Name, Address FROM Employees WHERE Employee_ID = '130' and DEPT = 'Accounting'
```

Selecting Multiple Database Rows

When the SQL query contains a SELECT statement, the transformation returns one row for each database row it retrieves. You must configure an output port for each column in the SELECT statement. The output ports must be in the same order as the columns in the SELECT statement.

When you configure output ports for database columns, you need to configure the datatype of each database column you select. Select a native datatype from the list. When you select the native datatype, the Designer configures the transformation datatype for you.

The native datatype in the transformation must match the database column datatype. The Integration Service matches the column datatype in the database with the native database type in the transformation at run time. If the datatypes do not match, the Integration Service generates a row error.

Note: Although the Teradata database allows Bigint columns, the Transformation Developer does not include Bigint datatype as one of the native datatypes you can use in the SQL transformation.

The following figure shows the ports in the transformation configured to run in query mode:

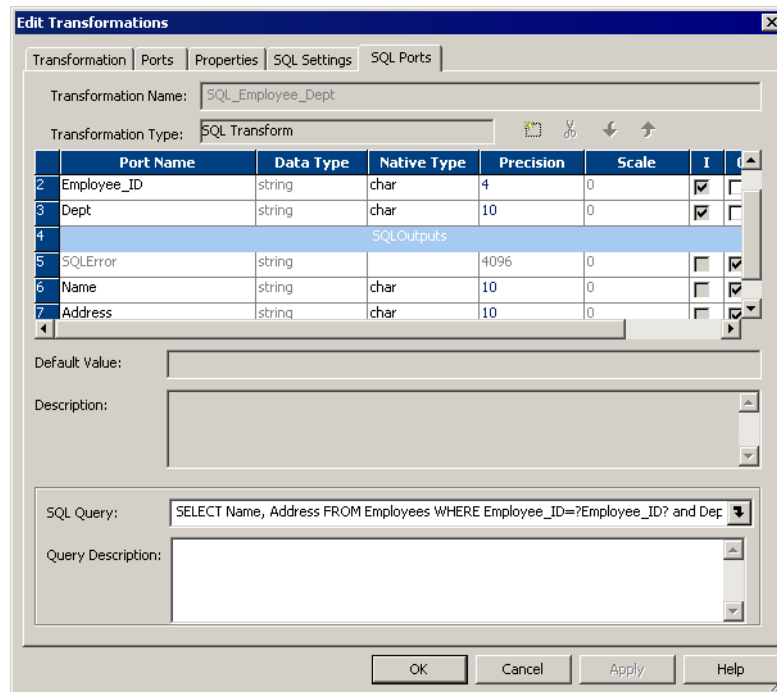

The input ports receive the data in the WHERE clause. The output ports return the columns from the SELECT statement. The SQL query selects name and address from the employees table. The SQL transformation writes a row to the target for each database row it retrieves.

Using Dynamic SQL Queries

A dynamic SQL query can execute different query statements for each input row. When you create a dynamic SQL query, you use string substitution to define string parameters in the query and link them to input ports in the transformation.

To change a query statement, configure a string variable in the query for the portion of the query you want to change. To configure the string variable, identify an input port by name in the query and enclose the name with the tilde (~). The query changes based on the value of the data in the port. The transformation input port that contains the query parameter must be a string datatype. You can use string substitution to change the query statement and the query data.

When you create a dynamic SQL query, the Integration Service prepares a query for each input row. You can pass the full query or pass part of the query in an input port:

- **Full query.** You can substitute the entire SQL query with query statements from source data.
- **Partial query.** You can substitute a portion of the query statement, such as the table name.

Passing the Full Query

You can pass the full SQL query through an input port in the transformation. To pass the full query, create a query in the SQL Editor that consists of one string variable to represent the full query:

```
~Query_Port~
```

The transformation receives the query in the Query_Port input port.

The following figure shows ports in the SQL transformation:

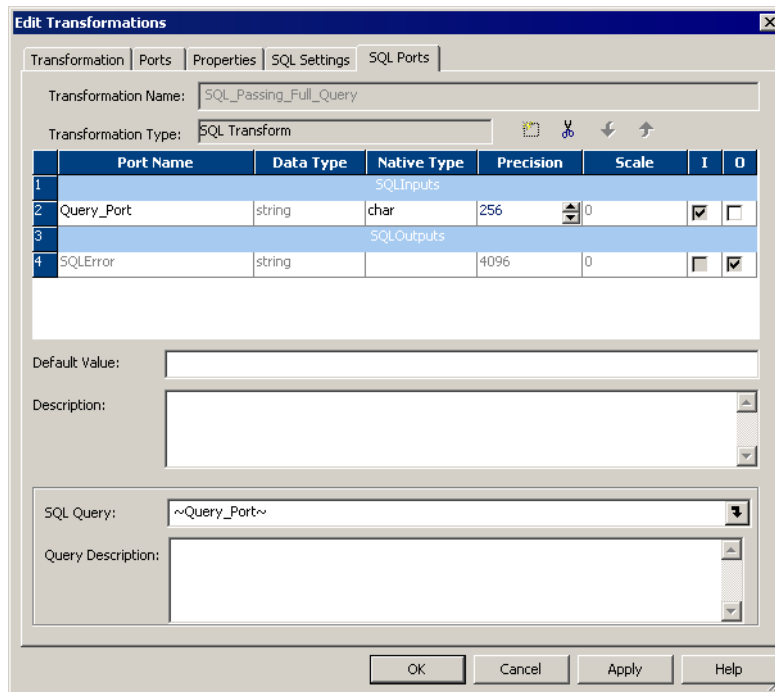

The Integration Service replaces the ~Query_Port~ variable in the dynamic query with the SQL statements from the source. It prepares the query and sends it to the database to process. The database executes the query. The SQL transformation returns database errors to the SQLError port.

The following mapping shows how to pass the query to the SQL transformation:

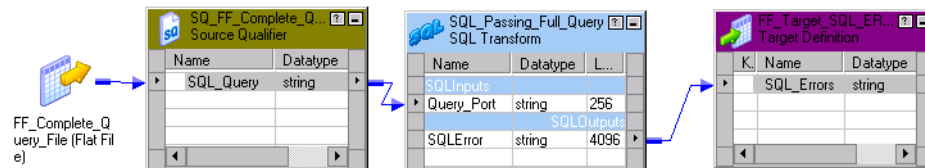

When you pass the full query, you can pass more than one query statement for each input row. For example, the source might contain the following rows:

```
DELETE FROM Person WHERE LastName = 'Jones'; INSERT INTO Person (LastName, Address)
VALUES ('Smith', '38 Summit Drive')
DELETE FROM Person WHERE LastName = 'Jones'; INSERT INTO Person (LastName, Address)
VALUES ('Smith', '38 Summit Drive')
DELETE FROM Person WHERE LastName = 'Russell';
```

You can pass any type of query in the source data. When you configure SELECT statements in the query, you must configure output ports for the database columns you retrieve from the database. When you mix SELECT statements and other types of queries, the output ports that represent database columns contain null values when no database columns are retrieved.

Substituting the Table Name in a String

You can substitute the table name in a query. To substitute the table name, configure an input port to receive the table name from each input row. Identify the input port by name in the query and enclose the name with the tilde (~).

The following dynamic query contains a string variable, ~Table_Port~:

```
SELECT Emp_ID, Address from ~Table_Port~ where Dept = 'HR'
```

The source might pass the following values to the Table_Port column:

Table_Port

Employees_USA

Employees_England

Employees_Australia

The Integration Service replaces the ~Table_Port~ variable with the table name in the input port:

```
SELECT Emp_ID, Address from Employees_USA where Dept = 'HR'  
SELECT Emp_ID, Address from Employees_England where Dept = 'HR'  
SELECT Emp_ID, Address from Employees_Australia where Dept = 'HR'
```

RELATED TOPICS:

- [“Dynamic Update Example” on page 429](#)

Pass-Through Ports Configuration

You can add pass-through ports to the SQL transformation. Pass-through ports are input/output ports that pass data through the transformation. The SQL transformation returns data from the pass-through ports whether a SQL query returns rows or not.

When the source row contains a SELECT query statement, the SQL transformation returns the data in the pass-through port in each row it returns from the database. If the query result contains multiple rows, the SQL transformation repeats the pass-through data in each row.

When a query returns no rows, the SQL transformation returns the pass-through column data with null values in the output columns. For example, queries that contain INSERT, UPDATE, and DELETE statements return no rows. When the query has errors, the SQL transformation returns the pass-through column data, the SQL error message, and null values in the output ports.

To create a pass-through port:

- Create an input port and enable it for output. The Designer creates an output port and adds an “_output” suffix to the port name.
- Drag a port from a Source Qualifier transformation to the SQL transformation. The Designer creates a pass-through port.

Passive Mode Configuration

When you create a SQL transformation, you can configure the SQL transformation to run in passive mode instead of active mode. A passive transformation does not change the number of rows that pass through it. It maintains transaction boundaries, and maintains row types.

If you configure the transformation to run in Query mode, you can configure passive mode when you create the transformation. You cannot change the mode after you create the transformation.

Rules and Guidelines for Passive Mode

Use the following rules and guidelines when you configure the SQL transformation to run in passive mode:

- If a SELECT query returns more than one row, the Integration Service returns the first row and an error to the SQLError port. The error states that the SQL transformation generated multiple rows.
- If the SQL query has multiple SQL statements, then the Integration Service executes all the statements. The Integration Service returns data for the first SQL statement only. The SQL transformation returns one row. The SQLError port contains the errors from all the SQL statements. When multiple errors occur, they are separated by semi-colons in the SQLError port.
- If the SQL query has multiple SQL statements and a statistics port is enabled, the Integration Service returns the data and statistics for the first SQL statement. The SQLError port contains the errors for all the SQL statements.

Rules and Guidelines for Query Mode

Use the following rules and guidelines when you configure the SQL transformation to run in query mode:

- The number and the order of the output ports must match the number and order of the fields in the query SELECT clause.
- The native datatype of an output port in the transformation must match the datatype of the corresponding column in the database. The Integration Service generates a row error when the datatypes do not match.
- When the SQL query contains an INSERT, UPDATE, or DELETE clause, the transformation returns data to the SQLError port, the pass-through ports, and the NumRowsAffected port when it is enabled. If you add output ports the ports receive NULL data values.
- When the SQL query contains a SELECT statement and the transformation has a pass-through port, the transformation returns data to the pass-through port whether or not the query returns database data. The SQL transformation returns a row with NULL data in the output ports.
- You cannot add the "_output" suffix to output port names that you create.
- You cannot use the pass-through port to return data from a SELECT query.
- When the number of output ports is more than the number of columns in the SELECT clause, the extra ports receive a NULL value.
- When the number of output ports is less than the number of columns in the SELECT clause, the Integration Service generates a row error.
- You can use string substitution instead of parameter binding in a query. However, the input ports must be string datatypes.

Connecting to Databases

You can use a static database connection or you can pass database connection information to the SQL transformation at run time.

You can use a connection environment SQL statement or transactional SQL statement with the SQL transformation. Configure the SQL statements in a relational connection object. The Integration Service runs the connection environment SQL when it connects to the database. It runs the transactional SQL statement before the initiation of each transaction.

Use one of the following types of connections to connect the SQL transformation to a database:

- **Static connection.** Configure the connection object in the session. You must first create the connection object in Workflow Manager.
- **Logical connection.** Pass a connection name to the SQL transformation as input data at run time. You must first create the connection object in Workflow Manager.
- **Full database connection.** Pass the connect string, user name, password, and other connection information to the SQL transformation input ports at run time.

Note: If a session has multiple partitions, the SQL transformation creates a separate database connection for each partition.

Using a Static Database Connection

You can configure the SQL transformation to connect to a database with a static connection. A static database connection is a database connection defined in the Workflow Manager.

To use a static connection, choose a relational connection object when you configure the session. To avoid datatype conversion errors, use a relational connection for the same database type that is configured in the transformation.

Passing a Logical Database Connection

You can configure the SQL transformation to connect to a database with a logical database connection. A logical database connection is a connection object name that you pass to the transformation at run time. Define the relational connection object in the Workflow Manager. When you configure the transformation to use a logical database connection, the Designer creates the LogicalConnectionObject input port.

You can pass a logical connection for each input row. Configure the mapping to pass the connection object name to the LogicalConnectionObject port. To avoid datatype conversion errors, use a relational connection for the same database type that is configured in the transformation.

Passing Full Connection Information

You can pass all the database connection information to an SQL transformation as input port data. When you configure the SQL transformation to connect to a database with a full connection, the Designer creates input ports for connection components. The database type defaults to the database type you configured for the transformation.

The following table describes the ports that the Designer creates when you configure an SQL transformation to connect to a database with a full connection:

Port	Required/Optional	Description
ConnectionString	Required	Contains the database name and database server name.
DBUser	Required	Name of the user with permissions to read and write from the database.
DBPasswd	Required	DBUser password.

Port	Required/Optional	Description
CodePage	Optional	Code page the Integration Service uses to read from or write to the database. Use the ISO code page name, such as ISO-8859-6. The code page name is not case sensitive.
AdvancedOptions	Optional	Connection attributes. Pass the attributes as name-value pairs. Delimit each attribute from another with a semicolon. Attribute names are not case sensitive.

Passing the Connect String

The native connect string contains the database name and database server name. The connect string allows PowerCenter and the database client to direct calls to the correct database.

The following table lists the native connect string syntax for each database:

Database	Connect String Syntax	Example
IBM DB2	<i>dbname</i>	mydatabase
Microsoft SQL Server	<i>servername@dbname</i>	sqlserver@mydatabase
Oracle	<i>dbname.world</i> (same as TNSNAMES entry)	oracle.world
Sybase ASE ¹	<i>servername@dbname</i>	sambrown@mydatabase
Teradata ²	<i>ODBC_data_source_name</i> or <i>ODBC_data_source_name@db_name</i> or <i>ODBC_data_source_name@db_user_name</i>	TeradataODBC TeradataODBC@mydatabase TeradataODBC@sambrown
Vertica	<i>ODBC_data_source_name</i>	VerticaDSN

¹. Sybase ASE *servername* is the name of the Adaptive Server from the interfaces file.

². Use Teradata ODBC drivers to connect to source and target databases.

Passing Advanced Options

You can configure optional connection attributes. To configure the attributes, pass the attributes as name-value pairs. Delimit attributes with a semicolon. Attribute names are not case sensitive.

For example, you might pass the following string to configure connection options:

```
Use Trusted Connection = 1; Connection Retry Period = 5
```

The following table describes the advanced options that you can configure:

Attribute	Database Type	Description
Connection Retry Period	All	Integer. The number of seconds the Integration Service attempts to reconnect to the database if the connection fails.
Data Source Name	Teradata	String. The name of the Teradata ODBC data source.
Database Name	Sybase ASE Microsoft SQL Server Teradata	String. Override the default database name in the ODBC. If you do not enter a database name, messages related to the connection do not show a database name.
Domain Name	Microsoft SQL Server	String. The name of the domain where Microsoft SQL Server is running.
Enable Parallel Mode	Oracle	Integer. Enable parallel processing when you load data in bulk mode. 0 is not enabled. 1 is enabled. Default is enabled.
Owner Name	All	String. The table owner name.
Packet Size	Sybase ASE Microsoft SQL Server	Integer. Optimize the ODBC connection to Sybase ASE and Microsoft SQL Server.
Server Name	Sybase ASE Microsoft SQL Server	String. The name of the database server.
Use Trusted Connection	Microsoft SQL Server	Integer. When enabled, the Integration Service uses Windows authentication to access the Microsoft SQL Server database. The user name that starts the Integration Service must be a valid Windows user with access to the Microsoft SQL Server database. 0 is not enabled. 1 is enabled.

Rules and Guidelines for Database Connections

Use the following rules and guidelines when configuring database connections for the SQL transformation:

- You need the PowerCenter license key to connect different database types. A session fails if PowerCenter is not licensed to connect to the database.
- To improve performance, use a static database connection. When you configure a dynamic connection, the Integration Service establishes a new connection for each input row.

- When you have a limited number of connections to use in a session, you can configure multiple SQL transformations. Configure each SQL transformation to use a different static connection. Use a Router transformation to route rows to a SQL transformation based on connectivity information in the row.
- When you configure the SQL transformation to use full connection data, the database password is plain text. You can pass logical connections when you have a limited number of connections you need to use in a session. A logical connection provides the same functionality as the full connection, and the database password is secure.
- When you pass logical database connections to the SQL transformation, the Integration Service accesses the repository to retrieve the connection information for each input row. When you have many rows to process, passing logical database connections might have a performance impact.
- The SQL transformation uses a native database type by default. If you want to run the session using ODBC, you must configure the transformation with an ODBC database type. If the transformation contains a datetime or datetime2 port, set the corresponding native type as timestamp.

Session Processing

When the Integration Service processes an SQL transformation, it runs SQL queries midstream in the pipeline. When a SELECT query retrieves database rows, the SQL transformation returns the database columns in the output ports. For other types of queries, the SQL transformation returns query results, pass-through data, or database errors in output ports.

The SQL transformation configured to run in script mode always returns one row for each input row. A SQL transformation that runs in query mode can return a different number of rows for each input row. The number of rows the SQL transformation returns is based on the type of query it runs and the success of the query.

You can view a log of the SQL query that the Integration Service passes to the database for processing. When you set logging to verbose, the Integration Service writes each SQL query to the session log. Set logging to verbose when you need to debug a session with the SQL transformation.

You can use transaction control with the SQL transformation when you configure the transformation to use a static database connection. You can also issue commit and rollback statements in the query.

The SQL transformation provides some database connection resiliency. It provides resilience for database deadlocks.

RELATED TOPICS:

- [“Input Row to Output Row Cardinality” on page 419](#)
- [“High Availability” on page 417](#)

Transaction Control

An SQL transformation that runs in script mode drops any incoming transaction boundary from an upstream source or transaction generator. The Integration Service issues a commit after executing the script for each input row in the SQL transformation. The transaction contains the set of rows affected by the script.

An SQL transformation that runs in query mode commits transactions at different points based on the database connection type:

- **Dynamic database connection.** The Integration Service issues a commit after executing the SQL for each input row. The transaction is the set of rows affected by the script. You cannot use a Transaction Control transformation with dynamic connections in query mode.

- **Static connection.** The Integration Service issues a commit after processing all the input rows. The transaction includes all the database rows to update. You can override the default behavior by using a Transaction Control transformation to control the transaction, or by using commit and rollback statements in the SQL query.

When you configure an SQL statement to commit or rollback rows, configure the SQL transformation to generate transactions with the Generate Transaction transformation property. Configure the session for user-defined commit.

The following transaction control SQL statements are not valid with the SQL transformation:

- **SAVEPOINT.** Identifies a rollback point in the transaction.
- **SET TRANSACTION.** Changes transaction options.

RELATED TOPICS:

- [“Dynamic Connection Example” on page 434](#)

Auto-Commit

You can configure the SQL transformation database connections to operate in auto-commit mode. When you configure auto-commit mode, a commit occurs when a SQL statement completes.

To enable auto-commit, select AutoCommit on the SQL Settings tab of the SQL transformation.

If HA recovery is enabled with auto-commit, the session log contains a warning message that data integrity cannot be guaranteed if the query contains an insert, update, or delete statement.

High Availability

When you have high availability, the SQL transformation provides database connection resiliency for static and dynamic connections. When the Integration Service fails to connect to the database, it retries the connection. You can configure the connection retry period for a connection. When the Integration Service cannot connect to the database in the time period that you configure, it generates a row error for a dynamic connection or fails the session for a static connection.

Note: The SQL transformation database connection is not resilient for Informix or ODBC connections.

Exactly-Once Processing for Real-time Sessions

The Integration Service provides exactly-once delivery of messages of real-time sources with the SQL transformation. A real-time message has to be delivered once to the SQL transformation. If there is an interruption in processing, the Integration Service can recover without requiring the message to be sent again. If the message is sent again, the Integration Service does not run DML statements from the message twice. The Integration Service might run other SQL statements such as SELECT or SET again.

To perform exactly-once processing, the Integration Service stores a state of operations for a checkpoint in the PM_REC_STATE table. Each SQL transformation has a separate state of operations. Each SQL transformation maintains a consistent state and does not share connections. You must have high availability for exactly-once processing.

Use the following rules and guidelines for recovering real-time sessions with SQL transformations:

- You must set the transformation scope to Transaction to enable recovery for a sessions that contains an SQL transformation.
- You cannot include auto-commit, commit statements, or DDL statements in SQL queries.

- You cannot enable HA recovery for an SQL transformation if it is a passive transformation, or if you configured it for dynamic connections or for Script Mode .
- A session may fail when you enable recovery for the SQL transformation and the workflow is enabled for concurrent execution or the session runs in multiple partitions. A database deadlock might occur on the PM_REC_STATE table.

Query Mode Resilience

When a database connection error occurs while the Integration Service is executing a SQL query for an input row, the Integration Service attempts to reconnect to the database.

Use the following rules and guidelines for resiliency in query mode:

- When the Integration Service is executing the first query in a list, and a database connection failure occurs, the Integration Service re-executes the first query in the list for the row. It executes the rest of the queries for that row.
- If the first query statement is a SELECT statement and a communication failure occurs after some rows are flushed downstream in the pipeline, the session fails.
- If a connection failure occurs while the Integration Service is executing a query that not the first query in a list, the Integration Service re-connects to the database and skips the rest of the queries for the current row. Query results might be lost for the previous rows.
- If the Integration Service is not able to reconnect to the database, the session fails if the SQL transformation is using a static connection. If the SQL transformation is using a dynamic connection, the session continues.
- If the SQL query in the list has an explicit commit or rollback statement, any query results that were created after the commit point will be lost when the session continues.

Script Mode Resilience

When a communication failure occurs while the Integration Service is executing a script for an input row, the Integration Service tries to re-connect to the database.

Use the following rules and guidelines for resiliency in script mode:

- If the Integration Service fails to connect to the database, and the connection is static, the session fails. If the SQL transformation is using a dynamic connection, the session continues.
- If the Integration Service re-connects to the database, it skips processing the current row and continues to the next row.

Database Deadlock Resiliency

The SQL transformation is resilient to database deadlock errors when you enable the Session Retry on Deadlock session property. The SQL transformation is resilient to database deadlock errors in Query mode but it is not resilient to deadlock errors in Script mode. If a deadlock occurs in Query mode, the Integration Service tries to reconnect to the database for the number of deadlock retries that you configure. Configure the Integration Service to set the number of deadlock retries and the deadlock sleep time period.

When a deadlock occurs, the Integration Service retries the SQL statements in the current row if the current row has no DML statements. If the row contain a DML statement such as INSERT, UPDATE, or DELETE, the Integration Service does not process the current row again.

For a dynamic connection, if the retry attempt fails, the Integration Service returns an error in the SQLError port. The Integration Service processes the next statement based on the Continue on SQL Error Within Row

property. If the property is disabled, the Integration Service skips the current row. If the current row contains a DML statement such as INSERT, UPDATE, or DELETE, the Integration Service increments the error count.

For a static connection, if the retry attempts fail, the Integration Service returns an error in the SQLError port. If the current row contains a DML statement, then the Integration Service fails the session. The Integration Service processes the next statement based on Continue on SQL Error Within a Row property. If the property is disabled the Integration Service skips the current row.

SQL Query Log

You can view a log of the SQL query that the Integration Service passes to the database for processing. When you set logging to verbose, the Integration Service writes each SQL query to the session log. Set logging to verbose when you need to debug a session with the SQL transformation.

If the query contains CLOB or BLOB data, the session log contains does not contain the query. The session log contains a message that describes the data, such as CLOB Data.

Input Row to Output Row Cardinality

When the Integration Service runs a SELECT query, the SQL transformation returns a row for each row it retrieves. When the query does not retrieve data, the SQL transformation returns zero or one row for each input row.

The number of output rows the SQL transformation returns depends on the following factors:

- **Query statement processing.** When the query contains a SELECT statement, the Integration Service can retrieve multiple output rows. When a SELECT query is successful, the SQL transformation might retrieve multiple rows. When the query contains other statements, the Integration Service might generate a row that contains SQL errors or the number of rows affected.
- **Port configuration.** The NumRowsAffected output port contains the total number of rows affected by updates, inserts, or deletes for one input row. When the SQL transformation contains pass-through ports, the transformation returns the column data at least once for each source row.
- **The maximum row count configuration.** The Max Output Row Count limits the number of rows the SQL transformation returns from SELECT queries.
- **Error rows.** The Integration Service returns row errors when it encounters connection or syntax errors. When the SQL transformation runs in query mode, it returns errors to the SQLError port. When the SQL transformation runs in script mode, it returns errors to the ScriptError port.
- **Continue on SQL Error.** You can configure the SQL transformation to continue processing when there is an error in a SQL statement. The SQL transformation does not generate a row error.

Query Statement Processing

The type of query determines how many rows the SQL transformation returns. The SQL transformation running in query mode can return zero, one, or multiple rows. When the query contains a SELECT statement, the SQL transformation returns each column from the database to an output port. The transformation returns all qualifying rows.

The following table lists the output rows the SQL transformation generates for different types of query statements when no errors occur in query mode:

Query Statement	Output Rows
UPDATE, INSERT, DELETE only	Zero rows.
One or more SELECT statements	Total number of database rows retrieved.
DDL queries such as CREATE, DROP, TRUNCATE	Zero rows.

Number of Rows Affected

You can enable the NumRowsAffected output port to return the number of rows affected by the INSERT, UPDATE, or DELETE query statements in each input row. The Integration Service returns the NumRowsAffected for each statement in the query. NumRowsAffected is disabled by default.

When you enable NumRowsAffected in query mode, and the SQL query does not contain an INSERT, UPDATE, or DELETE statement, NumRowsAffected is zero in each output row.

Note: When you enable NumRowsAffected and the transformation is configured to run in script mode, NumRowsAffected is always NULL.

The following table lists the output rows the SQL transformation generates when you enable NumRowsAffected in query mode:

Query Statement	Output Rows
UPDATE, INSERT, DELETE only	One row for each statement with the NumRowsAffected for the statement.
One or more SELECT statements	Total number of database rows retrieved. NumRowsAffected is zero in each row.
DDL queries such as CREATE, DROP, TRUNCATE	One row with zero NumRowsAffected.

When the SQL transformation runs in query mode and a query contains multiple statements, the Integration Service returns the NumRowsAffected for each statement. NumRowsAffected contains the sum of the rows affected by each INSERT, UPDATE, and DELETE statement in an input row.

For example, a query contains the following statements:

```
DELETE from Employees WHERE Employee_ID = '101';
SELECT Employee_ID, LastName from Employees WHERE Employee_ID = '103';
INSERT into Employees (Employee_ID, LastName, Address)VALUES ('102', 'Gein', '38 Beach Rd')
```

The DELETE statement affects one row. The SELECT statement does not affect any row. The INSERT statement affects one row.

The Integration Service returns one row from the DELETE statement. NumRowsAffected is equal to one. It returns one row from the SELECT statement, NumRowsAffected is zero. It returns one row from the INSERT statement with NumRows Affected equal to one.

The NumRowsAffected port returns zero when all of the following conditions are true:

- The database is Informix.

- The transformation is running in query mode.
- The query contains no parameters.

Maximum Output Row Count

You can limit the number of rows the SQL transformation returns for SELECT queries. Configure the Max Output Row Count property to limit number of rows. When a query contains multiple SELECT statements, the SQL transformation limits total rows from all the SELECT statements.

For example, you set Max Output Row Count to 100. The query contains two SELECT statements:

```
SELECT * FROM table1; SELECT * FROM table2;
```

If the first SELECT statement returns 200 rows, and the second SELECT statement returns 50 rows, the SQL transformation returns 100 rows from the first SELECT statement. It returns no rows from the second statement.

To configure unlimited output rows, set Max Output Row Count to zero.

Understanding Error Rows

The Integration Service returns row errors when it encounters a connection error or syntax error. The SQL transformation has the following default ports to output error text:

- **SQLException**. Returns database errors when the SQL transformation runs in query mode.
- **ScriptError**. Returns database errors when the SQL transformation runs in script mode.

When the SQL query contains syntax errors, the error port contains the error text from the database. For example, the following SQL query generates a row error from an Oracle database:

```
SELECT Product_ID FROM Employees
```

The Employees table does not contain Product_ID. The Integration Service generates one row. The SQLException port contains the error text in one line:

```
ORA-0094: "Product_ID": invalid identifier Database driver error... Function Name:
Execute SQL Stmt: SELECT Product_ID from Employees Oracle Fatal Error
```

When a query contains multiple statements, and you configure the SQL transformation to continue on SQL error, the SQL transformation might return rows from the database for one query statement, but return database errors for another query statement. The SQL transformation returns any database error in a separate row.

When you configure a pass-through port or the NumRowsAffected port, the SQL transformation returns at least one row for each source row. When a query returns no data, the SQL transformation returns the pass-through data and the NumRowsAffected values, but it returns null values in the output ports. You can remove rows with null values by passing the output rows through a Filter transformation.

The following tables describe the output rows that the SQL transformation returns based on the type of query statements.

The following table describes the rows the SQL transformation generates for UPDATE, INSERT, or DELETE query statements:

NumRowsAffected Port or Pass-Through Port Configured	SQLError	Rows Output
Neither port configured.	No	Zero rows.
Neither port configured.	Yes	One row with the error in the SQLError port.
Either port configured.	No	One row for each query statement with the NumRowsAffected or the pass-through column data.
Either port configured.	Yes	One row with the error in the SQLError port, the NumRowsAffected port, or the pass-through port data.

The following table describes the number of output rows the SQL transformation generates for SELECT statements:

NumRowsAffected Port or Pass-Through Port Configured	SQLError	Rows Output
Neither port configured.	No	Zero or more rows, based on the rows returned from each SELECT statement.
Neither port configured.	Yes	One row greater than the sum of the output rows for the successful statements. The last row contains the error in the SQLError port.
Either port configured.	No	One or more rows, based on the rows returned for each SELECT statement: <ul style="list-style-type: none"> - If NumRowsAffected is enabled, each row contains a NumRowsAffected column with a value zero. - If a pass-through port is configured, each row contains the pass-through column data. When the query returns multiple rows, the pass-through column data is duplicated in each row.
Either port configured.	Yes	One or more rows, based on the rows returned for each SELECT statement. The last row contains the error in the SQLError port: <ul style="list-style-type: none"> - When NumRowsAffected is enabled, each row contains a NumRowsAffected column with value zero. - If a pass-through port is configured, each row contains the pass-through column data. When the query returns multiple rows, the pass-through column data is duplicated in each row.

The following table describes the number of output rows the SQL transformation generates for DDL queries such as CREATE, DROP, or TRUNCATE:

NumRowsAffected Port or Pass-Through Port Configured	SQLError	Rows Output
Neither port configured.	No	- Zero rows.
Neither port configured.	Yes	- One row that contains the error in the SQLError port.
Either port configured.	No	- One row that includes the NumRowsAffected column with value zero and the pass-through column data.
Either port configured.	Yes	- One row with the error in the SQLError port, the NumRowsAffected column with value zero, and the pass-through column data.

Continuing on SQL Error

You can choose to ignore an SQL error in a statement by enabling the Continue on SQL Error within a Row option. The Integration Service continues to run the rest of the SQL statements for the row. The Integration Service does not generate a row error. However, the SQLError port contains the failed SQL statement and error messages. A session fails when the row error count exceeds the session error threshold.

For example, a query might have the following statements:

```
DELETE FROM Persons WHERE FirstName = 'Ed';

INSERT INTO Persons (LastName, Address)VALUES ('Gein', '38 Beach Rd')
```

If the DELETE statement fails, the SQL transformation returns an error message from the database. The Integration Service continues processing the INSERT statement.

Tip: Disable the Continue on SQL Error option to debug database errors. Otherwise, you might not be able to associate errors with the query statements that caused them.

SQL Transformation Properties

After you create the SQL transformation, you can define ports and set attributes in the following transformation tabs:

- **Ports.** Displays the transformation ports and attributes that you create on the SQL Ports tab.
- **Properties.** SQL transformation general properties.
- **SQL Settings.** Attributes unique to the SQL transformation.
- **SQL Ports.** SQL transformation ports and attributes.

Note: You cannot update the columns on the Ports tab. When you define ports on the SQL Ports tab, they display on the Ports tab.

Properties Tab

Configure the SQL transformation general properties on the Properties tab. Some transformation properties do not apply to the SQL transformation or are not configurable.

The following table describes the SQL transformation properties:

Property	Description
RunTime Location	<p>Location that contains the DLL or shared library.</p> <p>Enter a path relative to the Integration Service node that runs the SQL transformation session. If this property is blank, the Integration Service uses the environment variable defined on the Integration Service node to locate the DLL or shared library.</p> <p>You must copy all DLLs or shared libraries to the run-time location or to the environment variable defined on the Integration Service node. The Integration Service fails to load the procedure when it cannot locate the DLL, shared library, or a referenced file.</p>
Tracing Level	<p>Sets the amount of detail included in the session log when you run a session containing this transformation. When you configure the SQL transformation tracing level to Verbose Data, the Integration Service writes each SQL query it prepares to the session log.</p>
IsPartitionable	<p>Multiple partitions in a pipeline can use this transformation. Use the following options:</p> <ul style="list-style-type: none"> - No. The transformation cannot be partitioned. The transformation and other transformations in the same pipeline are limited to one partition. You might choose No if the transformation processes all the input data together, such as data cleansing. - Locally. The transformation can be partitioned, but the Integration Service must run all partitions in the pipeline on the same node. Choose Locally when different partitions of the transformation must share objects in memory. - Across Grid. The transformation can be partitioned, and the Integration Service can distribute each partition to different nodes. <p>Default is No.</p>
Update Strategy Transformation	<p>The transformation defines the update strategy for output rows. You can enable this property for query mode SQL transformations.</p> <p>Default is disabled.</p>
Transformation Scope	<p>The method in which the Integration Service applies the transformation logic to incoming data. Use the following options:</p> <ul style="list-style-type: none"> - Row - Transaction - All Input <p>Set transaction scope to transaction when you use transaction control in static query mode.</p> <p>Default is Row for script mode transformations.</p> <p>Default is All Input for query mode transformations.</p>
Output is Repeatable	<p>Indicates if the order of the output data is consistent between session runs.</p> <ul style="list-style-type: none"> - Never. The order of the output data is inconsistent between session runs. - Based On Input Order. The output order is consistent between session runs when the input data order is consistent between session runs. - Always. The order of the output data is consistent between session runs even if the order of the input data is inconsistent between session runs. <p>Default is Never.</p>
Generate Transaction	<p>The transformation generates transaction rows. Enable this property for query mode SQL transformations that commit data in an SQL query.</p> <p>Default is disabled.</p>

Property	Description
Requires Single Thread Per Partition	Indicates if the Integration Service processes each partition of a procedure with one thread.
Output is Deterministic	The transformation generates consistent output data between session runs. Enable this property to perform recovery on sessions that use this transformation. Default is enabled.

Warning: If you configure a transformation as repeatable and deterministic, it is your responsibility to ensure that the data is repeatable and deterministic. If you try to recover a session with transformations that do not produce the same data between the session and the recovery, the recovery process can result in corrupted data.

SQL Settings Tab

Configure SQL transformation attributes on the SQL Settings tab. The SQL attributes are unique to the SQL transformation.

The following table lists the attributes you can configure on the SQL Setting tab:

Option	Description
Continue on SQL Error within row	Continues processing the remaining SQL statements in a query after an SQL error occurs.
Add Statistic Output Port	Adds a NumRowsAffected output port. The port returns the total number of database rows affected by INSERT, DELETE, and UPDATE query statements for an input row.
AutoCommit	Enables auto-commit for each database connection. Each SQL statement in a query defines a transaction. A commit occurs when the SQL statement completes or the next statement is executed, whichever comes first
Max Output Row Count	Defines the maximum number of rows the SQL transformation can output from a SELECT query. To configure unlimited rows, set Max Output Row Count to zero.
Scripts Locale	Identifies the code page for a SQL script. Choose the code page from the list. Default is operating system locale.
Use Connection Pooling	Maintain a connection pool for database connections. You can enable connection pooling for dynamic connections only.
Maximum Number of Connections in Pool	Maximum number of active connections available in the connection pool. Minimum is one. Maximum is 20. Default is 10.

SQL Ports Tab

When you create an SQL transformation, the Designer adds default ports depending on how you configure the transformation. After you create the transformation, you can add ports to the transformation on the SQL Ports tab.

The following table lists the SQL transformation ports:

Port	Type	Mode	Description
ScriptName	Input	Script	The name of the script to execute for each row.
ScriptError	Output	Script	SQL errors the database passes back to the transformation when the script fails.
ScriptResult	Output	Script	Results from query execution. Contains PASSED when the query executes successfully. Contains FAILED when the query is not successful.
SQLException	Output	Query	SQL errors the database passes back to the transformation.
LogicalConnectionObject	Input	Query	Dynamic connection. The name of a connection defined in Workflow Manager connections.
Connect String	Input	Query Script	Connection object only. The database name and the database server name.
DBUser	Input	Query Script	Full connection only. The name of the user with permissions to read and write from the database.
DBPasswd	Input	Query Script	Full connection only. The database password.
CodePage	Input	Query Script	Full connection only. The code page the Integration Service uses to read from or write to the database.
Advanced Options	Input	Query Script	Full connection only. Optional connection attributes such as packet size, connection retry period, and enable parallel mode.
NumRowsAffected	Output	Query Script	The total number of database rows affected by INSERT, DELETE, and UPDATE query statements for an input row.

SQL Statements

The following table lists the statements you can use with the SQL transformation:

Statement Type	Statement	Description
Data Definition	ALTER	Modifies the structure of the database.
Data Definition	COMMENT	Adds comments to the data dictionary.
Data Definition	CREATE	Creates a database, table, or index.
Data Definition	DROP	Deletes an index, table, or database.
Data Definition	RENAME	Renames a database object.

Statement Type	Statement	Description
Data Definition	TRUNCATE	Removes all rows from a table.
Data Manipulation	CALL	Calls a PL/SQL or Java subprogram.
Data Manipulation	DELETE	Deletes rows from a table.
Data Manipulation	EXPLAIN PLAN	Writes the access plan for a statement into the database Explain tables.
Data Manipulation	INSERT	Inserts row into a table.
Data Manipulation	LOCK TABLE	Prevents concurrent application processes from using or changing a table.
Data Manipulation	MERGE	Updates a table with source data.
Data Manipulation	SELECT	Retrieves data from the database.
Data Manipulation	UPDATE	Updates the values of rows of a table.
Data Control Language	GRANT	Grants privileges to a database user.
Data Control Language	REVOKE	Removes access privileges for a database user.
Transaction Control	COMMIT	Saves a unit of work and performs the database changes for that unit of work.
Transaction Control	ROLLBACK	Reverses changes to the database since the last COMMIT.

Creating an SQL Transformation

You can create an SQL transformation in the Transformation Developer or the Mapping Designer.

To create an SQL transformation:

1. Click Transformation > Create.
2. Select the SQL transformation.
3. Enter a name for the transformation.
The naming convention for an SQL transformation is SQL_TransformationName.
4. Enter a description for the transformation and click Create.
5. Configure the SQL transformation mode:
 - **Query mode.** Configure an active transformation that executes dynamic SQL queries.
 - **Script mode.** Configure a passive transformation that executes external SQL scripts.
6. Configure the database type that the SQL transformation connects to. Choose the database type from the list.

7. Configure the SQL transformation connection options:

Option	Description
Static Connection	Use a connection object that you configure for the session. The SQL transformation connects to the database once during a session.
Dynamic Connection	Connect to databases depending on connection information you pass to the transformation in a mapping. When you configure a dynamic connection, choose whether the transformation requires a connection object name or the transformation requires all the connection information. Default is connection object.
Connection Object	Dynamic connection only. Use a LogicalConnectionObject port to receive the connection object name. Define the connection object in the Workflow Manager connections.
Full Connection Information	Dynamic connection only. Use input ports to receive all the connection components.

8. To configure the SQL transformation to run in passive mode, select SQL Transformation Will Run in Passive Mode.
9. Click OK to configure the transformation.
The Designer creates default ports in the transformation based on the options that you choose. You cannot change the configuration except for the database type.
10. Click the Ports tab to add ports to the transformation. Add pass-through ports after database ports.

CHAPTER 27

Using the SQL Transformation in a Mapping

This chapter includes the following topics:

- [SQL Transformation Example Overview, 429](#)
- [Dynamic Update Example, 429](#)
- [Dynamic Connection Example, 434](#)

SQL Transformation Example Overview

The SQL transformation processes SQL queries midstream in a pipeline. The transformation processes external SQL scripts or SQL queries that you create in an SQL editor. You can pass the database connection information to the SQL transformation as input data at run time.

This chapter provides two examples that illustrate SQL transformation functionality. You use the examples in this chapter to create and execute dynamic SQL queries and to connect dynamically to databases. The chapter provides sample data and descriptions of the transformations that you can include in mappings.

The chapter provides the following examples:

- **Creating a dynamic SQL query to update a database.** The dynamic query update example shows how update product prices in a table based on a price code received from a source file.
- **Configuring a dynamic database connection.** The dynamic connection example shows how to connect to different databases based on the value of a customer location in a source row.

Dynamic Update Example

This example shows how to configure an Expression transformation and an SQL transformation to generate SQL queries based on the value of a column in a source file.

In this example, you have a database table that contains product prices. You need to update the prices from a transaction file. Each transaction row updates the wholesale, retail, or manufacturing prices in the database based on a price code column.

The source file is a flat file. You can configure an Expression transformation to return the column names to update based on the value of a price code column in each source row. The Expression transformation passes

the column names to the SQL transformation. The SQL transformation runs a dynamic SQL query that updates columns in the Prod_Cost table based on the column names it receives. The SQL transformation returns database errors to the Error_File target.

The following figure shows the how the Expression transformation passes column names to the SQL transformation:

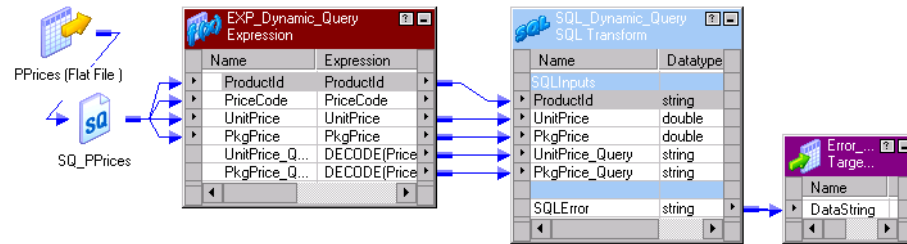

The mapping contains the following components:

- **PPrices source definition.** The PPrices flat file contains a product ID, package price, unit price, and price code. The price code defines whether the package price and unit price are wholesale, retail, or manufactured prices.
- **Error_File flat file target definition.** The target contains the Datastring field that receives database errors from the SQL transformation.
- **Exp_Dynamic_Expression transformation.** The Expression transformation defines which Prod_Cost column names to update based on the value of the PriceCode column. It returns the column names in the UnitPrice_Query and PkgPrice_Query ports.
- **SQL_Dynamic_Query transformation.** The SQL transformation has a dynamic SQL query to update a UnitPrice column and a PkgPrice column in the Prod_Cost table. It updates the columns named in the UnitPrice_Query and PkgPrice_Query columns.

Note: The mapping does not contain a relational table definition for the Prod_Cost table. The SQL transformation has a static connection to the database that contains the Prod_Cost table. The transformation generates the SQL statements to update the unit prices and package prices in the table.

Defining the Source File

The transaction file is a flat file source that contains the prices to update in the database. Each row has a code that defines whether the prices are wholesale, retail, or manufacturer prices. The source file name is PPrices.dat.

You can create a PPrices.dat file in Srcfiles that contains the following rows:

```
100, M, 100, 110
100, W, 120, 200
100, R, 130, 300
200, M, 210, 400
200, W, 220, 500
200, R, 230, 600
300, M, 310, 666
300, W, 320, 680
300, R, 330, 700
```

You can import the PPrices.dat file to create the PPrices source definition in the repository.

The PPrices file contains the following columns:

Column	Datatype	Precision	Description
ProductID	String	10	A unique number that identifies the product to update.
PriceCode	String	2	M, W, or R. Defines whether the prices are Manufactured, Wholesale, or Retail prices.
UnitPrice	Number	10	The price for each unit of the product.
PkgPrice	Number	10	The price for a package of the product.

Creating a Target Definition

The Error_File is a flat file target definition that receives database error messages from the SQL transformation.

The Error_File definition has the following input port:

Port Name	Datatype	Precision	Scale
DataString	String	4000	0

Create the target definition in the Target Designer.

Creating the Database Table

The SQL transformation writes product prices to the Prod_Cost relational table. The Prod_Cost table contains unit and package prices for each product. It stores the wholesale, retail, and manufacturing prices by unit and package.

You do not create a relational target definition for the Prod_Cost table in the repository. The SQL transformation generates the SQL statements to update the table in the database.

The Prod_Cost table contains the following columns:

Type of Costs	Datatype	Description
ProductID	varchar	A unique number that identifies the product to update.
WUnitPrice	number	Wholesale unit price.
WPkgPrice	number	Wholesale package price.
RUnitPrice	number	Retail unit price.
RPkgPrice	number	Retail package price.
MUnitPrice	number	Manufacturers unit price.
MPkgPrice	number	Manufacturers package price.

The following SQL statements create the Prod_Cost table and three product rows on an Oracle database:

```

Create table Prod_Cost (ProductId varchar (10), WUnitPrice number, WPkgPrice number,
RUnitPrice number, RPkgPrice number,MUnitPrice number, MPkgPrice number );
insert into Prod_Cost values ('100',0,0,0,0,0,0);
insert into Prod_Cost values ('200',0,0,0,0,0,0);
insert into Prod_Cost values ('300',0,0,0,0,0,0);
commit;

```

Configuring the Expression Transformation

The Expression transformation has an input/output port for each source column. It passes column names to the SQL transformation based on the value of the PriceCode column.

The following figure shows the ports in the Expression transformation that return column names:

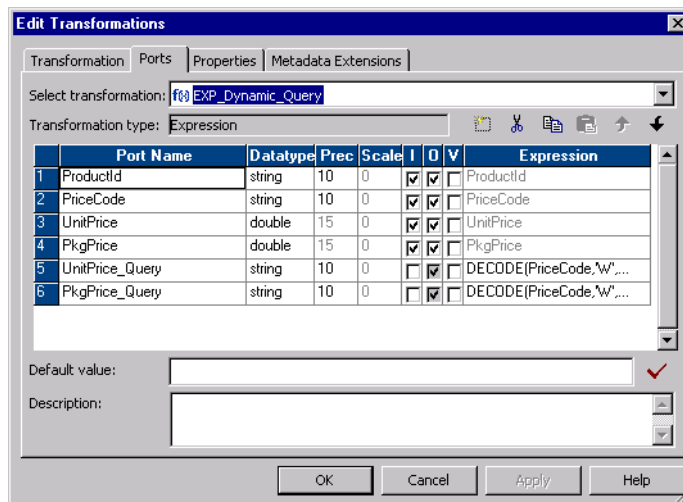

The SQL transformation has the following columns that contain the results of expressions:

- **UnitPrice_Query.** Returns the column name “MUnitprice,” “RUnitPrice,” or “WUnitprice” based on the whether the price code is “M,” “R,” or “W.”

```
DECODE(PriceCode,'M', 'MUnitPrice','R', 'RUnitPrice','W', 'WUnitPrice')
```

- **PkgPrice_Query.** Returns the column name “MPkgPrice,” “RPkgPrice,” or “WPkgPrice,” based on the whether the price code is “M,” “R,” or “W.”

```
DECODE(PriceCode,'M', 'MPkgPrice','R', 'RPkgPrice','W', 'WPkgPrice')
```

Defining the SQL Transformation

The SQL transformation executes a dynamic SQL query that inserts the unit price and package price data into the Prod_Cost table. The SQL transformation receives the column names to update in the UnitPrice_Query and PkgPrice_Query ports.

When you create an SQL transformation, you define the transformation mode, the database type, and the type of connection. You cannot change the mode or connection type after you create the transformation.

Create an SQL transformation with the following properties:

- **Query Mode.** The SQL transformation executes dynamic SQL queries.
- **Static Connection.** The SQL transformation connects once to the database with the connection object you define in the Workflow Manager.

The following figure shows the SQL transformation Ports tab with its SQL Query and Query Description:

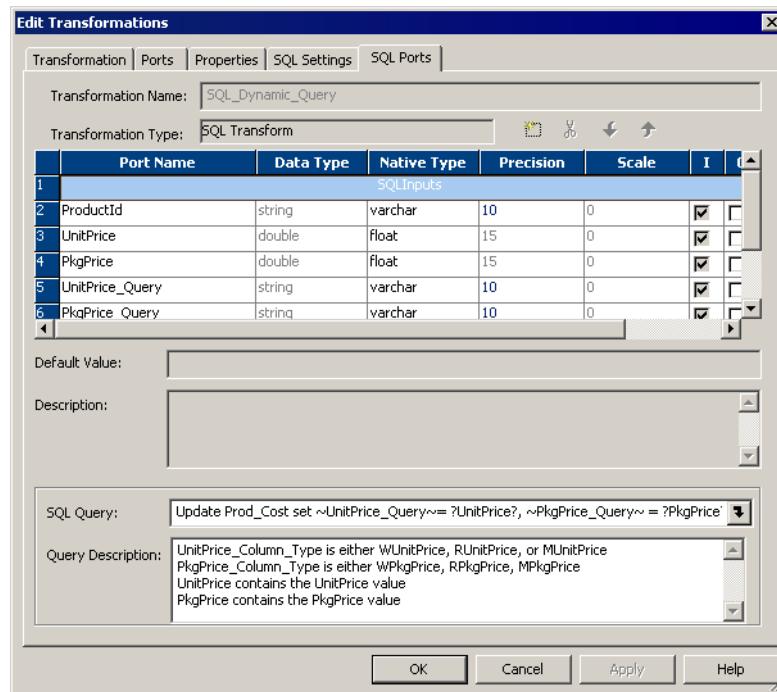

The SQL transformation has a dynamic SQL query that updates one of the UnitPrice columns and one of the PkgPrice columns in the Prod_Cost table based on the column names it receives in the UnitPrice_Query and the PkgPrice_Query ports.

The SQL transformation has the following query:

```
Update Prod_Cost set ~UnitPrice_Query~ = ?UnitPrice?, ~PkgPrice_Query~ = ?PkgPrice?
where ProductId = ?ProductId?;
```

The SQL transformation substitutes the UnitPrice_Query and PkgPrice_Query string variables with the column names to update.

The SQL transformation binds the ProductId, UnitPrice and PkgPrice parameters in the query with data that it receives in the corresponding ports.

For example, the following source row contains a unit price and a package price for product 100:

```
100,M,100,110
```

When the PriceCode is "M," the prices are manufacturing prices. The Expression transformation passes MUnitprice and MPkgPrice column names to the SQL transformation to update.

The SQL transformation executes the following query:

```
Update Prod_Cost set MUnitprice = 100, MPkgPrice = 110 where ProductId = '100';
```

The following source row contains wholesale prices for product 100:

```
100,W,120,200
```

The Expression transformation passes WUnitprice and WPkgPrice column names to the SQL transformation. The SQL transformation executes the following query:

```
Update Prod_Cost set WUnitprice = 120, WPkgPrice = 200 where ProductId = '100';
```

Configuring Session Attributes

When you configure the session, configure the source file, target file, and the database connection:

Attribute	Value
Source File Name	PPrices.dat
Output File Name	ErrorFile.dat
SQL_Dynamic_Query Relational Connection	Connection to the test database that contains the Prod_Cost table.

Target Data Results

When you run a session with the sample data, the Integration Service populates the Prod_Cost target table with the following data:

ProductID	WUnitPrice	WPkgPrice	RUnitPrice	RPkgPrice	MUnitPrice	MPkgPrice
100	120	200	130	300	100	110
200	220	500	230	600	210	400
300	320	680	330	700	310	666

If the database returns any errors to the SQL transformation, the Error_File target contains the error text.

Dynamic Connection Example

The dynamic connection SQL transformation example shows how to dynamically connect to a database based on source file data.

In this example, you have a customer database for the United States, United Kingdom, and Canada. You need to insert customer data from a transaction file into a database based on where the customer is located.

The Expression transformation returns a database connection object name based on the value of the location column. The Expression transformation passes a connection object name to the SQL transformation LogicalConnectionObject port. The SQL transformation connects to the database based on value of the LogicalConnectionObject column.

The following figure shows the Expression transformation and the SQL transformation in a mapping:

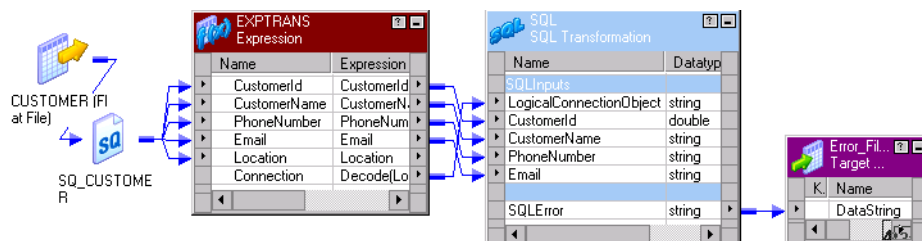

The mapping contains the following components:

- **Customer source definition.** A flat file source definition that includes customer information. The customer location determines which database the SQL transformation connects to when it inserts the customer data.
- **Error_File target definition.** The target contains a Datastring field that receives database errors from the SQL transformation.
- **Exp_Dynamic_Connection transformation.** The Expression transformation defines which database to connect to based on the value of the Location column. The Expression transformation returns the connection object name in the Connection port. The connection object is a database connection defined in the Workflow Manager.
- **SQL_Dynamic_Connection transformation.** The SQL transformation receives a connection object name in the LogicalConnectionPort. It connects to the database and inserts the customer data in the database.

Defining the Source File

The transaction file is a flat file source that contains the customer to add to the database. Each row has a location that defines the country where the customer lives. The source file name is Customer.dat.

A Customer file record contains the following fields:

Port Name	Datatype	Precision	Scale	Description
CustomerID	Number	10	0	Customer number that uniquely identifies a customer.
CustomerName	String	25	0	Name of the customer.
PhoneNumber	String	15	0	Telephone number includes area code and seven digits with no spaces.
Email	String	25	0	Customer email address.
Location	String	10	0	Customer location. Values are US, UK, CAN.

You can create a Customer.dat file in Srcfiles that contains the following rows:

```
1,John Smith,6502345677,jsmith@catgary.com,US
2,Nigel Whitman,5123456754,nwhitman@nwhitman.com,UK
3,Girish Goyal,5674325321,ggoyal@netcompany.com,CAN
4,Robert Gregson,5423123453,rgregson@networkmail.com,US
```

You can import the Customer.dat file to create the Customer source definition in the repository.

Creating a Target Definition

The Error_File is a flat file target definition that receives database error messages from the SQL transformation.

The Error_File definition includes the following input port:

Port Name	Datatype	Precision	Scale
DataString	String	4000	0

Create the target definition in the Target Designer.

Creating the Database Tables

For this example, you need to create three Oracle databases, a United States database, a United Kingdom database, and a Canadian database. Each database has a Cust table that contains the customer data for the region.

The following SQL statements create a Cust table on an Oracle database:

```
Create table Cust (CustomerId number, CustomerName varchar2(25), PhoneNumber
varchar2(15), Email varchar2(25));
```

Note: This example includes three databases to illustrate dynamic database connections. If the tables are in the same database, use a static database connection to improve performance.

Creating the Database Connections

Use the Workflow Manager to create database connections to the US, UK, and CAN databases.

In this example, the SQL transformation connects to the databases using the following connection names:

Database	Connection Object Name
US	DBORA_US
UK	DBORA_UK
CAN	DBORA_CAN

Configuring the Expression Transformation

The Expression transformation has an input/output port for each source column. The transformation returns a connection object name in the Connection port based on the results of an expression.

The following figure shows the Ports tab in the Expression transformation and the input/output port columns for each source column:

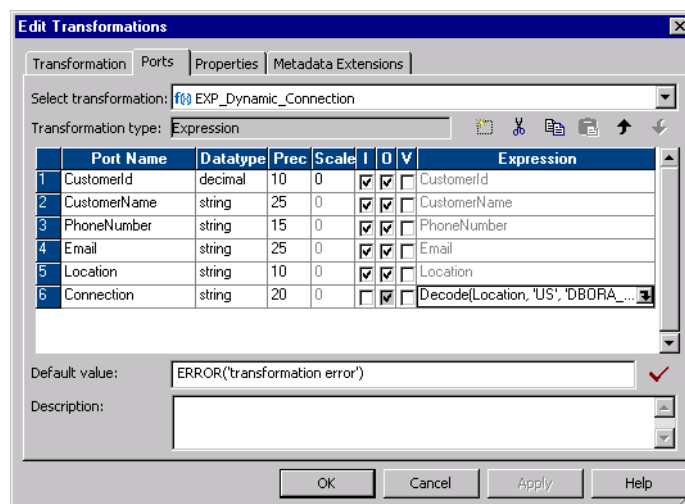

The Connection port has the following expression:

```
Decode(Location, 'US', 'DBORA_US','UK','DBORA_UK','CAN','DBORA_CAN','DBORA_US')
```

The expression returns a connection object name based on whether the location is US, UK, or CAN. When the location does not match a location in the expression, the connection object name defaults to "DBORA_US."

For example, the following source row customer information for a customer from the United States:

```
1,John Smith,6502345677,jsmith@catgary.com,US
```

When the customer location is "US", the Expression transformation returns the "DBORA_US" connection object name. The Expression transformation passes "DBORA_US" to the SQL transformation LogicalConnectionObject port.

Defining the SQL Transformation

The SQL transformation connects to the database and runs a dynamic SQL query that inserts the customer data into the CUST table.

When you create an SQL transformation, you define the transformation mode, the database type, and the type of connection. You cannot change the mode or connection type after you create the transformation.

Create an SQL transformation with the following properties:

- **Query Mode.** The SQL transformation executes dynamic SQL queries.
- **Dynamic Connection.** The SQL transformation connects to databases depending on connection information you pass to the transformation in a mapping.
- **Connection Object.** The SQL transformation has a LogicalConnectionObject port that receives the connection object name. The connection object must be defined in the Workflow Manager connections.

The following figure shows the ports in the SQL transformation:

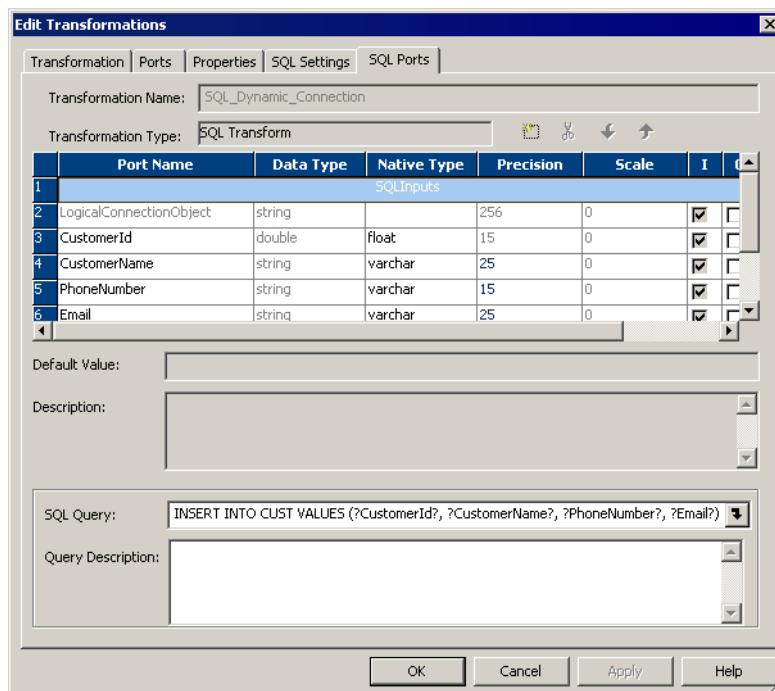

The SQL transformation receives the connection object name in the LogicalConnectionObject port. It connects to the database with the connection object name each time it processes a row.

The transformation has the following dynamic SQL query to insert the customer data into a CUST table:

```
INSERT INTO CUST VALUES (?CustomerId?,?CustomerName?,?PhoneNumber?,?Email?);
```

The SQL transformation substitutes parameters in the query with customer data from the input ports of the transformation. For example, the following source row contains customer information for customer number 1:

```
1,John Smith,6502345677,jsmith@catgary.com,US
```

The SQL transformation connects to the database with the DBORA_US connection object. It executes the following SQL query:

```
INSERT INTO CUST VALUES (1,'John Smith','6502345677','jsmith@catgary.com');
```

Configuring Session Attributes

Configure the session to access the following source and target:

Attribute	Value
Source File Name	Customer.dat
Output File Name	Error_File.dat

Note: Do not configure a database connection for the session. The SQL transformation can connect to a different database each time it processes an input row.

Target Data Results

When you run a session with the sample data, the Integration Service populates the Cust table in the United States, United Kingdom, or Canada database.

The United States database contains the following rows:

CustomerID	CustomerName	PhoneNumber	Email
1	John Smith	6502345677	jsmith@catagary.com
4	Robert Gregson	5423123453	rgregson@networkmail.com

The United Kingdom database contains the following row:

CustomerID	CustomerName	PhoneNumber	Email
2	Nigel Whitman	5123456754	nwhitman@nwhitman.com

The Canadian database contains the following row:

CustomerID	CustomerName	PhoneNumber	Email
3	Girish Goyal	5423123453	ggoyal@netcompany.com

If the database returns any errors to the SQL transformation, the Error_File target contains the error text.

CHAPTER 28

Stored Procedure Transformation

This chapter includes the following topics:

- [Stored Procedure Transformation Overview, 439](#)
- [Using a Stored Procedure in a Mapping, 443](#)
- [Writing a Stored Procedure, 443](#)
- [Creating a Stored Procedure Transformation, 445](#)
- [Configuring a Connected Transformation, 449](#)
- [Configuring an Unconnected Transformation, 450](#)
- [Error Handling, 454](#)
- [Stored Procedure Options, 455](#)
- [Expression Rules, 456](#)
- [Tips for Stored Procedure Transformations, 457](#)
- [Troubleshooting Stored Procedure Transformations, 457](#)

Stored Procedure Transformation Overview

A Stored Procedure transformation is an important tool for populating and maintaining databases. Database administrators create stored procedures to automate tasks that are too complicated for standard SQL statements. The Stored Procedure transformation is a passive transformation. You can configure a connected or unconnected Stored Procedure transformation.

A stored procedure is a precompiled collection of Transact-SQL, PL-SQL or other database procedural statements and optional flow control statements, similar to an executable script. Stored procedures are stored and run within the database. You can run a stored procedure with the EXECUTE SQL statement in a database client tool, just as you can run SQL statements. Unlike standard SQL, however, stored procedures allow user-defined variables, conditional statements, and other powerful programming features.

Not all databases support stored procedures, and stored procedure syntax varies depending on the database. You might use stored procedures to complete the following tasks:

- Check the status of a target database before loading data into it.
- Determine if enough space exists in a database.
- Perform a specialized calculation.
- Drop and recreate indexes.

Database developers and programmers use stored procedures for various tasks within databases, since stored procedures allow greater flexibility than SQL statements. Stored procedures also provide error handling and logging necessary for critical tasks. Developers create stored procedures in the database using the client tools provided with the database.

The stored procedure must exist in the database before creating a Stored Procedure transformation, and the stored procedure can exist in a source, target, or any database with a valid connection to the Integration Service.

You might use a stored procedure to perform a query or calculation that you would otherwise make part of a mapping. For example, if you already have a well-tested stored procedure for calculating sales tax, you can perform that calculation through the stored procedure instead of recreating the same calculation in an Expression transformation.

Input and Output Data

One of the most useful features of stored procedures is the ability to send data to the stored procedure, and receive data from the stored procedure. There are three types of data that pass between the Integration Service and the stored procedure:

- Input/output parameters
- Return values
- Status codes

Some limitations exist on passing data, depending on the database implementation, which are discussed throughout this chapter. Additionally, not all stored procedures send and receive data. For example, if you write a stored procedure to rebuild a database index at the end of a session, you cannot receive data, since the session has already finished.

Input/Output Parameters

For many stored procedures, you provide a value and receive a value in return. These values are known as input and output parameters. For example, a sales tax calculation stored procedure can take a single input parameter, such as the price of an item. After performing the calculation, the stored procedure returns two output parameters, the amount of tax, and the total cost of the item including the tax.

The Stored Procedure transformation sends and receives input and output parameters using ports, variables, or by entering a value in an expression, such as 10 or SALES.

Return Values

Most databases provide a return value after running a stored procedure. Depending on the database implementation, this value can either be user-definable, which means that it can act similar to a single output parameter, or it may only return an integer value.

The Stored Procedure transformation captures return values in a similar manner as input/output parameters, depending on the method that the input/output parameters are captured. In some instances, only a parameter or a return value can be captured.

If a stored procedure returns a result set rather than a single return value, the Stored Procedure transformation takes only the first value returned from the procedure.

Note: An Oracle stored function is similar to an Oracle stored procedure, except that the stored function supports output parameters or return values. In this chapter, any statements regarding stored procedures also apply to stored functions, unless otherwise noted.

Status Codes

Status codes provide error handling for the Integration Service during a workflow. The stored procedure issues a status code that notifies whether or not the stored procedure completed successfully. You cannot see this value. The Integration Service uses it to determine whether to continue running the session or stop. You configure options in the Workflow Manager to continue or stop the session in the event of a stored procedure error.

Connected and Unconnected

Stored procedures run in either connected or unconnected mode. The mode you use depends on what the stored procedure does and how you plan to use it in a session. You can configure connected and unconnected Stored Procedure transformations in a mapping.

- **Connected.** The flow of data through a mapping in connected mode also passes through the Stored Procedure transformation. All data entering the transformation through the input ports affects the stored procedure. You should use a connected Stored Procedure transformation when you need data from an input port sent as an input parameter to the stored procedure, or the results of a stored procedure sent as an output parameter to another transformation.
- **Unconnected.** The unconnected Stored Procedure transformation is not connected directly to the flow of the mapping. It either runs before or after the session, or is called by an expression in another transformation in the mapping.

The following table compares connected and unconnected transformations:

If you want to	Use this mode
Run a stored procedure before or after a session.	Unconnected
Run a stored procedure once during a mapping, such as pre- or post-session.	Unconnected
Run a stored procedure every time a row passes through the Stored Procedure transformation.	Connected or Unconnected
Run a stored procedure based on data that passes through the mapping, such as when a specific port does not contain a null value.	Unconnected
Pass parameters to the stored procedure and receive a single output parameter.	Connected or Unconnected
Pass parameters to the stored procedure and receive multiple output parameters. Note: To get multiple output parameters from an unconnected Stored Procedure transformation, you must create variables for each output parameter.	Connected or Unconnected
Run nested stored procedures.	Unconnected
Call multiple times within a mapping.	Unconnected

RELATED TOPICS:

- [“Configuring an Unconnected Transformation” on page 450](#)
- [“Configuring a Connected Transformation” on page 449](#)

Specifying when the Stored Procedure Runs

In addition to specifying the mode of the Stored Procedure transformation, you also specify when it runs. In the case of the unconnected stored procedure above, the Expression transformation references the stored procedure, which means the stored procedure runs every time a row passes through the Expression transformation. However, if no transformation references the Stored Procedure transformation, you have the option to run the stored procedure once before or after the session.

The following list describes the options for running a Stored Procedure transformation:

- **Normal.** The stored procedure runs where the transformation exists in the mapping on a row-by-row basis. This is useful for calling the stored procedure for each row of data that passes through the mapping, such as running a calculation against an input port. Connected stored procedures run only in normal mode.
- **Pre-load of the Source.** Before the session retrieves data from the source, the stored procedure runs. This is useful for verifying the existence of tables or performing joins of data in a temporary table.
- **Post-load of the Source.** After the session retrieves data from the source, the stored procedure runs. This is useful for removing temporary tables.
- **Pre-load of the Target.** Before the session sends data to the target, the stored procedure runs. This is useful for verifying target tables or disk space on the target system.
- **Post-load of the Target.** After the session sends data to the target, the stored procedure runs. This is useful for re-creating indexes on the database.

You can run more than one Stored Procedure transformation in different modes in the same mapping. For example, a pre-load source stored procedure can check table integrity, a normal stored procedure can populate the table, and a post-load stored procedure can rebuild indexes in the database. However, you cannot run the same instance of a Stored Procedure transformation in both connected and unconnected mode in a mapping. You must create different instances of the transformation.

If the mapping calls more than one source or target pre- or post-load stored procedure in a mapping, the Integration Service executes the stored procedures in the execution order that you specify in the mapping.

The Integration Service executes each stored procedure using the database connection you specify in the transformation properties. The Integration Service opens the database connection when it encounters the first stored procedure. The database connection remains open until the Integration Service finishes processing all stored procedures for that connection. The Integration Service closes the database connections and opens a new one when it encounters a stored procedure using a different database connection.

To run multiple stored procedures that use the same database connection, set these stored procedures to run consecutively. If you do not set them to run consecutively, you might have unexpected results in the target. For example, you have two stored procedures: Stored Procedure A and Stored Procedure B. Stored Procedure A begins a transaction, and Stored Procedure B commits the transaction. If you run Stored Procedure C before Stored Procedure B, using another database connection, Stored Procedure B cannot commit the transaction because the Integration Service closes the database connection when it runs Stored Procedure C.

Use the following guidelines to run multiple stored procedures within a database connection:

- The stored procedures use the same database connect string defined in the stored procedure properties.
- You set the stored procedures to run in consecutive order.
- The stored procedures have the same stored procedure type:
 - Source pre-load
 - Source post-load
 - Target pre-load

- Target post-load

Using a Stored Procedure in a Mapping

You must perform several steps to use a Stored Procedure transformation in a mapping. Since the stored procedure exists in the database, you must configure not only the mapping and session, but the stored procedure in the database as well.

To use a Stored Procedure transformation, complete the following steps:

1. Create the stored procedure in the database.

Before using the Designer to create the transformation, you must create the stored procedure in the database. You should also test the stored procedure through the provided database client tools.

2. Import or create the Stored Procedure transformation.

Use the Designer to import or create the Stored Procedure transformation, providing ports for any necessary input/output and return values.

3. Determine whether to use the transformation as connected or unconnected.

You must determine how the stored procedure relates to the mapping before configuring the transformation.

4. If connected, map the appropriate input and output ports.

You use connected Stored Procedure transformations just as you would most other transformations. Drag the appropriate input flow ports to the transformation, and create mappings from output ports to other transformations.

5. If unconnected, either configure the stored procedure to run pre- or post-session, or configure it to run from an expression in another transformation.

Since stored procedures can run before or after the session, you may need to specify when the unconnected transformation should run. On the other hand, if the stored procedure is called from another transformation, you write the expression in another transformation that calls the stored procedure. The expression can contain variables, and may or may not include a return value.

6. Configure the session.

The session properties in the Workflow Manager includes options for error handling when running stored procedures and several SQL override options.

Writing a Stored Procedure

Write SQL statements to create a stored procedure in the database, and you can add other Transact-SQL statements and database-specific functions. These can include user-defined datatypes and execution order statements.

Sample Stored Procedure

In the following example, the source database has a stored procedure that takes an input parameter of an employee ID number, and returns an output parameter of the employee name. In addition, a return value of 0 is returned as a notification that the stored procedure completed successfully.

The database table that contains employee IDs and names appears as follows:

Employee ID	Employee Name
101	Bill Takash
102	Louis Li
103	Sarah Ferguson

The stored procedure receives the employee ID 101 as an input parameter, and returns the name Bill Takash. Depending on how the mapping calls this stored procedure, any or all of the IDs may be passed to the stored procedure.

Since the syntax varies between databases, the SQL statements to create this stored procedure may vary. The client tools used to pass the SQL statements to the database also vary. Most databases provide a set of client tools, including a standard SQL editor. Some databases, such as Microsoft SQL Server, provide tools that create some of the initial SQL statements.

Note: The Integration Service fails sessions that contain stored procedure arguments with large objects.

Informix

In Informix, the syntax for declaring an output parameter differs from other databases. With most databases, you declare variables using IN or OUT to specify if the variable acts as an input or output parameter. Informix uses the keyword RETURNING, making it difficult to distinguish input/output parameters from return values. For example, you use the RETURN command to return one or more output parameters:

```
CREATE PROCEDURE GET_NAME_USING_ID (nID integer)
RETURNING varchar(20);
define nID integer;
define outVAR as varchar(20);
SELECT FIRST_NAME INTO outVAR FROM CONTACT WHERE ID = nID
return outVAR;
END PROCEDURE;
```

Notice that in this case, the RETURN statement passes the value of outVAR. Unlike other databases, however, outVAR is not a return value, but an output parameter. Multiple output parameters would be returned in the following manner:

```
return outVAR1, outVAR2, outVAR3
```

Informix does not pass a return value. The return value is not user-defined, but generated as an error-checking value. In the transformation, the R value must be checked.

Oracle

In Oracle, any stored procedure that returns a value is called a stored function. Rather than using the CREATE PROCEDURE statement to make a new stored procedure based on the example, you use the CREATE FUNCTION statement. In this sample, the variables are declared as IN and OUT, but Oracle also supports an INOUT parameter type, which lets you pass in a parameter, modify it, and return the modified value:

```
CREATE OR REPLACE FUNCTION GET_NAME_USING_ID (
nID IN NUMBER,
outVAR OUT VARCHAR2)
RETURN VARCHAR2 IS
RETURN_VAR varchar2(100);
BEGIN
SELECT FIRST_NAME INTO outVAR FROM CONTACT WHERE ID = nID;
RETURN_VAR := 'Success';
RETURN (RETURN_VAR);
```

```
END;  
/
```

Notice that the return value is a string value (Success) with the datatype VARCHAR2. Oracle is the only database to allow return values with string datatypes.

Sybase ASE and Microsoft SQL Server

Sybase and Microsoft implement stored procedures identically, as the following syntax shows:

```
CREATE PROCEDURE GET_NAME_USING_ID @nID int = 1, @outVar varchar(20) OUTPUT  
AS  
SELECT @outVar = FIRST_NAME FROM CONTACT WHERE ID = @nID  
return 0
```

Notice that the return value does not need to be a variable. In this case, if the SELECT statement is successful, a 0 is returned as the return value.

IBM DB2

The following text is an example of an SQL stored procedure on IBM DB2:

```
CREATE PROCEDURE get_name_using_id ( IN id_in int,  
                                     OUT emp_out char(18),  
                                     OUT sqlcode_out int)  
  
    LANGUAGE SQL  
P1: BEGIN  
    -- Declare variables  
    DECLARE SQLCODE INT DEFAULT 0;  
    DECLARE emp_TMP char(18) DEFAULT ' ' ;  
    -- Declare handler  
    DECLARE EXIT HANDLER FOR SQLEXCEPTION  
        SET SQLCODE_OUT = SQLCODE;  
    select employee into emp_TMP  
        from doc_employee  
        where id = id_in;  
    SET emp_out      = EMP_TMP;  
    SET sqlcode_out = SQLCODE;  
END P1
```

Teradata

The following text is an example of an SQL stored procedure on Teradata. It takes an employee ID number as an input parameter and returns the employee name as an output parameter:

```
CREATE PROCEDURE GET_NAME_USING_ID (IN nID integer, OUT outVAR varchar(40))  
BEGIN  
    SELECT FIRST_NAME INTO :outVAR FROM CONTACT where ID = :nID;  
END;
```

Creating a Stored Procedure Transformation

After you configure and test a stored procedure in the database, you must create the Stored Procedure transformation in the Mapping Designer. There are two ways to configure the Stored Procedure transformation:

- Use the Import Stored Procedure dialog box to configure the ports used by the stored procedure.
- Configure the transformation manually, creating the appropriate ports for any input or output parameters.

Stored Procedure transformations are created as Normal type by default, which means that they run during the mapping, not before or after the session.

New Stored Procedure transformations are not created as reusable transformations. To create a reusable transformation, click Make Reusable in the Transformation properties after creating the transformation.

Note: Configure the properties of reusable transformations in the Transformation Developer, not the Mapping Designer, to make changes globally for the transformation.

Importing Stored Procedures

When you import a stored procedure, the Designer creates ports based on the stored procedure input and output parameters. You should import the stored procedure whenever possible.

There are three ways to import a stored procedure in the Mapping Designer:

- Select the stored procedure icon and add a Stored Procedure transformation.
- Click Transformation > Import Stored Procedure.
- Click Transformation > Create, and then select Stored Procedure.

When you import a stored procedure containing a period (.) in the stored procedure name, the Designer substitutes an underscore (_) for the period in the Stored Procedure transformation name.

To import a stored procedure:

1. In the Mapping Designer, click Transformation > Import Stored Procedure.
2. Select the database that contains the stored procedure from the list of ODBC sources. Enter the user name, owner name, and password to connect to the database and click Connect.

The folder in the dialog box displays FUNCTIONS. The stored procedures in this folder contain input parameters, output parameters, or a return value. If stored procedures exist in the database that do not contain parameters or return values, they appear in a folder called PROCEDURES. This applies primarily to Oracle stored procedures. For a normal connected Stored Procedure to appear in the functions list, it requires at least one input and one output port.

Tip: You can select Skip to add a Stored Procedure transformation without importing the stored procedure. In this case, you need to manually add the ports and connect information within the transformation.

3. Optionally, use the search field to limit the number of procedures that appear.
4. Select the procedure to import and click OK.

The Stored Procedure transformation appears in the mapping. The Stored Procedure transformation name is the same as the stored procedure you selected. If the stored procedure contains input parameters, output parameters, or a return value, you see the appropriate ports that match each parameter or return value in the Stored Procedure transformation.

In this Stored Procedure transformation, you can see that the stored procedure contains the following value and parameters:

- An integer return value, called RETURN_VALUE, with an output port.
- A string input parameter, called nNAME, with an input port.
- An integer output parameter, called outVar, with an input and output port.

Note: If you change the transformation name, you need to configure the name of the stored procedure in the transformation properties. If you have multiple instances of the same stored procedure in a mapping, you must also configure the name of the stored procedure.

5. Open the transformation, and click the Properties tab.

Select the database where the stored procedure exists from the Connection Information row. If you changed the name of the Stored Procedure transformation to something other than the name of the stored procedure, enter the Stored Procedure Name.

6. Click OK.

Manually Creating Stored Procedure Transformations

To create a Stored Procedure transformation manually, you need to know the input parameters, output parameters, and return values of the stored procedure, if there are any. You must also know the datatypes of those parameters, and the name of the stored procedure. All these are configured through Import Stored Procedure.

To create a Stored Procedure transformation:

1. In the Mapping Designer, click Transformation > Create, and then select Stored Procedure.

The naming convention for a Stored Procedure transformation is the name of the stored procedure, which happens automatically. If you change the transformation name, then you need to configure the name of the stored procedure in the Transformation Properties. If you have multiple instances of the same stored procedure in a mapping, you must perform this step.

2. Click Skip.

The Stored Procedure transformation appears in the Mapping Designer.

3. Open the transformation, and click the Ports tab.

You must create ports based on the input parameters, output parameters, and return values in the stored procedure. Create a port in the Stored Procedure transformation for each of the following stored procedure parameters:

- An integer input parameter
- A string output parameter
- A return value

For the integer input parameter, you would create an integer input port. The parameter and the port must be the same datatype and precision. Repeat this for the output parameter and the return value.

The R column should be selected and the output port for the return value. For stored procedures with multiple parameters, you must list the ports in the same order that they appear in the stored procedure.

4. Click the Properties tab.

Enter the name of the stored procedure in the Stored Procedure Name row, and select the database where the stored procedure exists from the Connection Information row.

5. Click OK.

Although the repository validates and saves the mapping, the Designer does not validate the manually entered Stored Procedure transformation. No checks are completed to verify that the proper parameters or return value exist in the stored procedure. If the Stored Procedure transformation is not configured properly, the session fails.

Setting Options for the Stored Procedure

The following table describes the properties for a Stored Procedure transformation:

Setting	Description
Stored Procedure Name	Name of the stored procedure in the database. The Integration Service uses this text to call the stored procedure if the name of the transformation is different than the actual stored procedure name in the database. Leave this field blank if the transformation name matches the stored procedure name. When using the Import Stored Procedure feature, this name matches the stored procedure.
Connection Information	Specifies the database containing the stored procedure. You can define the database in the mapping, session, or parameter file: <ul style="list-style-type: none"> - Mapping. Select the relational connection object. - Session. Use the \$Source or \$Target connection variable. If you use one of these variables, the stored procedure must reside in the source or target database you specify when you run the session. Specify the database connection for each variable in the session properties. - Parameter file. Use the session parameter \$DBConnectionName, and define it in the parameter file. <p>By default, the Designer specifies \$Target for Normal stored procedure types. For source pre- and post-load, the Designer specifies \$Source. For target pre- and post-load, the Designer specifies \$Target. You can override these values in the session properties.</p>
Call Text	Text used to call the stored procedure. Only used when the Stored Procedure Type is not Normal. You must include all input parameters passed to the stored procedure within the call text. <p>You can also use a PowerCenter parameter or variable in the call text. Use any parameter or variable type that you can define in the parameter file.</p>
Stored Procedure Type	Determines when the Integration Service calls the stored procedure. The options include Normal (during the mapping) or pre- or post-load on the source or target database. Default is Normal.
Tracing Level	Amount of transaction detail reported in the session log file. Use the following tracing levels: <ul style="list-style-type: none"> - Terse - Normal - Verbose Initialization - Verbose Data <p>Default is Normal.</p>
Execution Order	Order in which the Integration Service calls the stored procedure used in the transformation, relative to any other stored procedures in the same mapping. Only used when the Stored Procedure Type is set to anything except Normal and more than one stored procedure exists.
Subsecond Precision	Specifies the subsecond precision for datetime ports. <p>You can change the precision for databases that have an editable scale for datetime data. You can change subsecond precision for Oracle Timestamp, Informix Datetime, and Teradata Timestamp datatypes.</p> <p>Enter a positive integer value from 0 to 9. Default is 6 (microseconds).</p>

Setting	Description
Output is Repeatable	<p>Indicates whether the transformation generates rows in the same order between session runs. The Integration Service can resume a session from the last checkpoint when the output is repeatable and deterministic. Use the following values:</p> <ul style="list-style-type: none"> - Always. The order of the output data is consistent between session runs even if the order of the input data is inconsistent between session runs. - Based on Input Order. The transformation produces repeatable data between session runs when the order of the input data from all input groups is consistent between session runs. If the input data from any input group is not ordered, then the output is not ordered. - Never. The order of the output data is inconsistent between session runs. You cannot configure recovery to resume from the last checkpoint if a transformation does not produce repeatable data. <p>Default is Based on Input Order.</p>
Output is Deterministic	<p>Indicates whether the transformation generates consistent output data between session runs. You must enable this property to perform recovery on sessions that use this transformation.</p> <p>Default is disabled.</p>

Warning: If you configure a transformation as repeatable and deterministic, it is your responsibility to ensure that the data is repeatable and deterministic. If you try to recover a session with transformations that do not produce the same data between the session and the recovery, the recovery process can result in corrupted data.

Changing the Stored Procedure

If the number of parameters or the return value in a stored procedure changes, you can either re-import it or edit the Stored Procedure transformation manually. The Designer does not verify the Stored Procedure transformation each time you open the mapping. After you import or create the transformation, the Designer does not validate the stored procedure. The session fails if the stored procedure does not match the transformation.

Configuring a Connected Transformation

The following figure shows a mapping that sends the ID from the Source Qualifier to an input parameter in the Stored Procedure transformation:

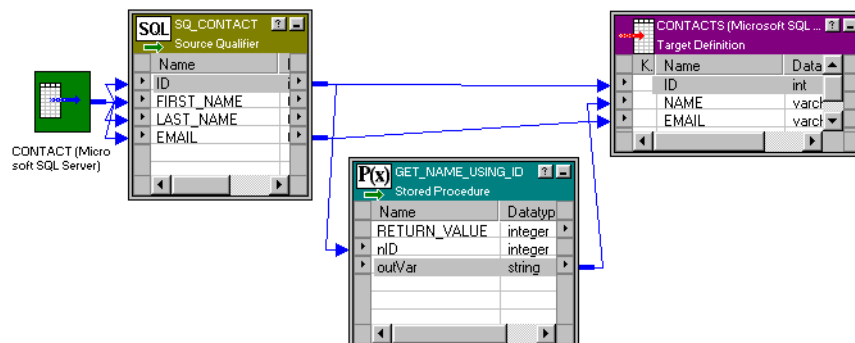

The Stored Procedure transformation passes an output parameter to the target. Every row of data in the Source Qualifier transformation passes data through the Stored Procedure transformation. Although not required, almost all connected Stored Procedure transformations contain input and output parameters. Required input parameters are specified as the input ports of the Stored Procedure transformation. Output parameters appear as output ports in the transformation. A return value is also an output port, and has the R value selected in the transformation Ports configuration. For a normal connected Stored Procedure to appear in the functions list, it requires at least one input and one output port.

Output parameters and return values from the stored procedure are used as any other output port in a transformation. You can link these ports to another transformation or target.

To configure a connected Stored Procedure transformation:

1. Create the Stored Procedure transformation in the mapping.
2. Drag the output ports of the Stored Procedure to other transformations or targets.
3. Open the Stored Procedure transformation, and select the Properties tab.
4. Select the appropriate database in the Connection Information if you did not select it when creating the transformation.
5. Select the Tracing level for the transformation.
If you are testing the mapping, select the Verbose Initialization option to provide the most information in the event that the transformation fails.
6. Click OK.

Configuring an Unconnected Transformation

An unconnected Stored Procedure transformation is not directly connected to the flow of data through the mapping. Instead, the stored procedure runs either:

- **From an expression.** Called from an expression written in the Expression Editor within another transformation in the mapping.
- **Pre- or post-session.** Runs before or after a session.

The sections below explain how you can run an unconnected Stored Procedure transformation.

Calling a Stored Procedure From an Expression

In an unconnected mapping, the Stored Procedure transformation does not connect to the pipeline.

The following figure shows a mapping with an Expression transformation that references the Stored Procedure transformation:

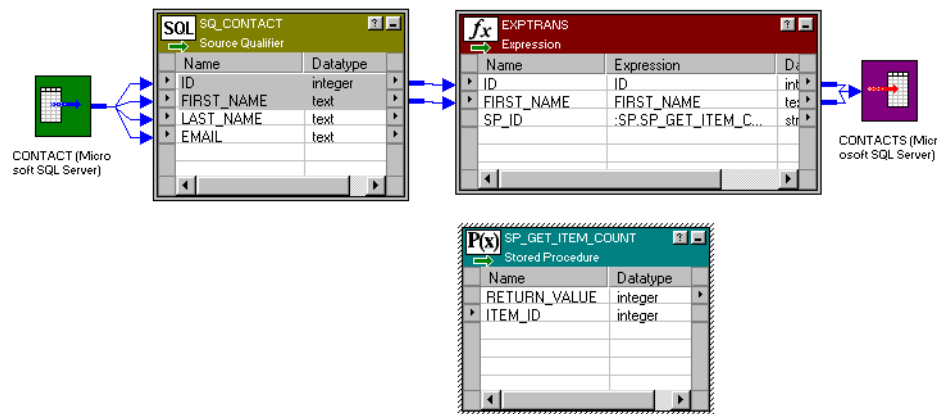

However, just like a connected mapping, you can apply the stored procedure to the flow of data through the mapping. In fact, you have greater flexibility since you use an expression to call the stored procedure, which means you can select the data that you pass to the stored procedure as an input parameter.

When using an unconnected Stored Procedure transformation in an expression, you need a method of returning the value of output parameters to a port. Use one of the following methods to capture the output values:

- Assign the output value to a local variable.
- Assign the output value to the system variable PROC_RESULT.

By using PROC_RESULT, you assign the value of the return parameter directly to an output port, which can apply directly to a target. You can also combine the two options by assigning one output parameter as PROC_RESULT, and the other parameter as a variable.

Use PROC_RESULT only within an expression. If you do not use PROC_RESULT or a variable, the port containing the expression captures a NULL. You cannot use PROC_RESULT in a connected Lookup transformation or within the Call Text for a Stored Procedure transformation.

If you require nested stored procedures, where the output parameter of one stored procedure passes to another stored procedure, use PROC_RESULT to pass the value.

The Integration Service calls the unconnected Stored Procedure transformation from the Expression transformation. Notice that the Stored Procedure transformation has two input ports and one output port. All three ports are string datatypes.

To call a stored procedure from within an expression:

1. Create the Stored Procedure transformation in the mapping.
2. In any transformation that supports output and variable ports, create a new output port in the transformation that calls the stored procedure. Name the output port.

The output port that calls the stored procedure must support expressions. Depending on how the expression is configured, the output port contains the value of the output parameter or the return value.

3. Open the Expression Editor for the port.

The value for the new port is set up in the Expression Editor as a call to the stored procedure using the :SP keyword in the Transformation Language. The easiest way to set this up properly is to select the Stored Procedures node in the Expression Editor, and click the name of Stored Procedure transformation

listed. For a normal connected Stored Procedure to appear in the functions list, it requires at least one input and one output port.

The stored procedure appears in the Expression Editor with a pair of empty parentheses. The necessary input and/or output parameters are displayed in the lower left corner of the Expression Editor.

4. Configure the expression to send input parameters and capture output parameters or return value.

You must know whether the parameters shown in the Expression Editor are input or output parameters. You insert variables or port names between the parentheses in the order that they appear in the stored procedure. The datatypes of the ports and variables must match those of the parameters passed to the stored procedure.

For example, when you click the stored procedure, something similar to the following appears:

```
:SP.GET_NAME_FROM_ID()
```

This particular stored procedure requires an integer value as an input parameter and returns a string value as an output parameter. How the output parameter or return value is captured depends on the number of output parameters and whether the return value needs to be captured.

If the stored procedure returns a single output parameter or a return value (but not both), you should use the reserved variable PROC_RESULT as the output variable. In the previous example, the expression would appear as:

```
:SP.GET_NAME_FROM_ID(inID, PROC_RESULT)
```

inID can be either an input port for the transformation or a variable in the transformation. The value of PROC_RESULT is applied to the output port for the expression.

If the stored procedure returns multiple output parameters, you must create variables for each output parameter. For example, if you create a port called varOUTPUT2 for the stored procedure expression, and a variable called varOUTPUT1, the expression appears as:

```
:SP.GET_NAME_FROM_ID(inID, varOUTPUT1, PROC_RESULT)
```

The value of the second output port is applied to the output port for the expression, and the value of the first output port is applied to varOUTPUT1. The output parameters are returned in the order they are declared in the stored procedure.

With all these expressions, the datatypes for the ports and variables must match the datatypes for the input/output variables and return value.

5. Click Validate to verify the expression, and then click OK to close the Expression Editor.

Validating the expression ensures that the datatypes for parameters in the stored procedure match those entered in the expression.

6. Click OK.

When you save the mapping, the Designer does not validate the stored procedure expression. If the stored procedure expression is not configured properly, the session fails. When testing a mapping using a stored procedure, set the Override Tracing session option to a verbose mode and configure the On Stored Procedure session option to stop running if the stored procedure fails. Configure these session options in the Error Handling settings of the Config Object tab in the session properties.

The stored procedure in the expression entered for a port does not have to affect all values that pass through the port. Using the IIF statement, for example, you can pass only certain values, such as ID numbers that begin with 5, to the stored procedure and skip all other values. You can also set up nested stored procedures so the return value of one stored procedure becomes an input parameter for a second stored procedure.

Calling a Pre- or Post-Session Stored Procedure

You may want to run a stored procedure once per session. For example, if you need to verify that tables exist in a target database before running a mapping, a pre-load target stored procedure can check the tables, and then either continue running the workflow or stop it. You can run a stored procedure on the source, target, or any other connected database.

To create a pre- or post-load stored procedure:

1. Create the Stored Procedure transformation in the mapping.
2. Double-click the Stored Procedure transformation, and select the Properties tab.
3. Enter the name of the stored procedure.

If you imported the stored procedure, the stored procedure name appears by default. If you manually set up the stored procedure, enter the name of the stored procedure.

4. Select the database that contains the stored procedure in Connection Information.
5. Enter the call text of the stored procedure.

The call text is the name of the stored procedure, followed by all applicable input parameters in parentheses. If there are no input parameters, you must include an empty pair of parentheses, or the call to the stored procedure fails. You do not need to include the SQL statement EXEC, nor do you need to use the :SP keyword. For example, to call a stored procedure called `check_disk_space`, enter the following text:

```
check_disk_space()
```

To pass a string input parameter, enter it without quotes. If the string has spaces in it, enclose the parameter in double quotes. For example, if the stored procedure `check_disk_space` required a machine name as an input parameter, enter the following text:

```
check_disk_space(oracle_db)
```

When passing a datetime value through a pre- or post-session stored procedure, the value must be in the Informatica default date format and enclosed in double quotes as follows:

```
SP("12/31/2000 11:45:59")
```

You can use PowerCenter parameters and variables in the call text. Use any parameter or variable type that you can define in the parameter file. You can enter a parameter or variable within the call text, or you can use a parameter or variable as the call text. For example, you can use a session parameter, `$ParamMyCallText`, as the call text, and set `$ParamMyCallText` to the call text in a parameter file.

Note: You must enter values instead of procedure parameters for the input parameters of pre- and post-session procedures.

6. Select the stored procedure type.

The options for stored procedure type include:

- **Source Pre-load.** Before the session retrieves data from the source, the stored procedure runs. This is useful for verifying the existence of tables or performing joins of data in a temporary table.
- **Source Post-load.** After the session retrieves data from the source, the stored procedure runs. This is useful for removing temporary tables.
- **Target Pre-load.** Before the session sends data to the target, the stored procedure runs. This is useful for verifying target tables or disk space on the target system.
- **Target Post-load.** After the session sends data to the target, the stored procedure runs. This is useful for re-creating indexes on the database.

7. Select Execution Order, and click the Up or Down arrow to change the order, if necessary.

If you have added several stored procedures that execute at the same point in a session, such as two procedures that both run at Source Post-load, you can set a stored procedure execution plan to determine the order in which the Integration Service calls these stored procedures. You need to repeat this step for each stored procedure you wish to change.

8. Click OK.

Although the repository validates and saves the mapping, the Designer does not validate whether the stored procedure expression runs without an error. If the stored procedure expression is not configured properly, the session fails. When testing a mapping using a stored procedure, set the Override Tracing session option to a verbose mode and configure the On Stored Procedure session option to stop running if the stored procedure fails. Configure these session options on the Error Handling settings of the Config Object tab in the session properties.

You lose output parameters or return values called during pre- or post-session stored procedures, since there is no place to capture the values. If you need to capture values, you might want to configure the stored procedure to save the value in a table in the database.

Error Handling

Sometimes a stored procedure returns a database error, such as “divide by zero” or “no more rows.” The final result of a database error during a stored procedure depends on when the stored procedure takes place and how the session is configured.

You can configure the session to either stop or continue running the session upon encountering a pre- or post-session stored procedure error. By default, the Integration Service stops a session when a pre- or post-session stored procedure database error occurs.

Pre-Session Errors

Pre-read and pre-load stored procedures are considered pre-session stored procedures. Both run before the Integration Service begins reading source data. If a database error occurs during a pre-session stored procedure, the Integration Service performs a different action depending on the session configuration.

- If you configure the session to stop upon stored procedure error, the Integration Service fails the session.
- If you configure the session to continue upon stored procedure error, the Integration Service continues with the session.

Post-Session Errors

Post-read and post-load stored procedures are considered post-session stored procedures. Both run after the Integration Service commits all data to the database. If a database error occurs during a post-session stored procedure, the Integration Service performs a different action depending on the session configuration:

- If you configure the session to stop upon stored procedure error, the Integration Service fails the session. However, the Integration Service has already committed all data to session targets.
- If you configure the session to continue upon stored procedure error, the Integration Service continues with the session.

Session Errors

Connected or unconnected stored procedure errors occurring during the session are not affected by the session error handling option. If the database returns an error for a particular row, the Integration Service skips the row and continues to the next row. As with other row transformation errors, the skipped row appears in the session log.

Stored Procedure Options

Stored procedures are stored and run within the database. When you use a stored procedure, you can configure options such as SQL declaration, parameter types, and input/output port in mappings.

When you use a stored procedure transformation, you can configure the additional options for Oracle, and other databases, such as Informix, Microsoft SQL Server, and Sybase.

RELATED TOPICS:

- [“Writing a Stored Procedure” on page 443](#)

SQL Declaration

In the database, the statement that creates a stored procedure appears similar to the following Oracle stored procedure:

```
create or replace procedure sp_combine_str
(str1_inout IN OUT varchar2,
str2_inout IN OUT varchar2,
str_out OUT varchar2)
is
begin
str1_inout := UPPER(str1_inout);
str2_inout := upper(str2_inout);
str_out := str1_inout || ' ' || str2_inout;
end;
```

In this case, the Oracle statement begins with CREATE OR REPLACE PROCEDURE. Since Oracle supports both stored procedures and stored functions, only Oracle uses the optional CREATE FUNCTION statement.

Parameter Types

There are three possible parameter types in stored procedures:

- **IN.** Defines the parameter something that must be passed to the stored procedure.
- **OUT.** Defines the parameter as a returned value from the stored procedure.
- **INOUT.** Defines the parameter as both input and output. Only Oracle supports this parameter type.

Input/Output Port in Mapping

Since Oracle supports the INOUT parameter type, a port in a Stored Procedure transformation can act as both an input and output port for the same stored procedure parameter. Other databases should not have both the input and output check boxes selected for a port.

Type of Return Value Supported

Different databases support different types of return value datatypes, and only Informix does not support user-defined return values.

Expression Rules

Unconnected Stored Procedure transformations can be called from an expression in another transformation. Use the following rules and guidelines when configuring the expression:

- A single output parameter is returned using the variable PROC_RESULT.
- When you use a stored procedure in an expression, use the :SP reference qualifier. To avoid typing errors, select the Stored Procedure node in the Expression Editor, and double-click the name of the stored procedure.
- However, the same instance of a Stored Procedure transformation cannot run in both connected and unconnected mode in a mapping. You must create different instances of the transformation.
- The input/output parameters in the expression must match the input/output ports in the Stored Procedure transformation. If the stored procedure has an input parameter, there must also be an input port in the Stored Procedure transformation.
- When you write an expression that includes a stored procedure, list the parameters in the same order that they appear in the stored procedure and the Stored Procedure transformation.
- The parameters in the expression must include all of the parameters in the Stored Procedure transformation. You cannot leave out an input parameter. If necessary, pass a dummy variable to the stored procedure.
- The arguments in the expression must be the same datatype and precision as those in the Stored Procedure transformation.
- Use PROC_RESULT to apply the output parameter of a stored procedure expression directly to a target. You cannot use a variable for the output parameter to pass the results directly to a target. Use a local variable to pass the results to an output port within the same transformation.
- Nested stored procedures allow passing the return value of one stored procedure as the input parameter of another stored procedure. For example, if you have the following two stored procedures:
 - get_employee_id (employee_name)
 - get_employee_salary (employee_id)And the return value for get_employee_id is an employee ID number, the syntax for a nested stored procedure is:

```
:sp.get_employee_salary (:sp.get_employee_id (employee_name))
```

You can have multiple levels of nested stored procedures.
- Do not use single quotes around string parameters. If the input parameter does not contain spaces, do not use any quotes. If the input parameter contains spaces, use double quotes.

Tips for Stored Procedure Transformations

Do not run unnecessary instances of stored procedures.

Each time a stored procedure runs during a mapping, the session must wait for the stored procedure to complete in the database. You have two possible options to avoid this:

- **Reduce the row count.** Use an active transformation prior to the Stored Procedure transformation to reduce the number of rows that must be passed the stored procedure. Or, create an expression that tests the values before passing them to the stored procedure to make sure that the value does not really need to be passed.
- **Create an expression.** Most of the logic used in stored procedures can be easily replicated using expressions in the Designer.

Troubleshooting Stored Procedure Transformations

I get the error “stored procedure not found” in the session log file.

Make sure the stored procedure is being run in the correct database. By default, the Stored Procedure transformation uses the target database to run the stored procedure. Double-click the transformation in the mapping, select the Properties tab, and check which database is selected in Connection Information.

My output parameter was not returned using a Microsoft SQL Server stored procedure.

Check if the parameter to hold the return value is declared as OUTPUT in the stored procedure. With Microsoft SQL Server, OUTPUT implies input/output. In the mapping, you probably have checked both the I and O boxes for the port. Clear the input port.

The session did not have errors before, but now it fails on the stored procedure.

The most common reason for problems with a Stored Procedure transformation results from changes made to the stored procedure in the database. If the input/output parameters or return value changes in a stored procedure, the Stored Procedure transformation becomes invalid. You must either import the stored procedure again, or manually configure the stored procedure to add, remove, or modify the appropriate ports.

The session has been invalidated since I last edited the mapping. Why?

Any changes you make to the Stored Procedure transformation may invalidate the session. The most common reason is that you have changed the type of stored procedure, such as from a Normal to a Post-load Source type.

CHAPTER 29

Transaction Control Transformation

This chapter includes the following topics:

- [Transaction Control Transformation Overview, 458](#)
- [Transaction Control Transformation Properties, 459](#)
- [Using Transaction Control Transformations in Mappings, 461](#)
- [Mapping Guidelines and Validation, 462](#)
- [Creating a Transaction Control Transformation, 463](#)

Transaction Control Transformation Overview

PowerCenter lets you control commit and roll back transactions based on a set of rows that pass through a Transaction Control transformation. A Transaction Control transformation is an active transformation. A transaction is the set of rows bound by commit or roll back rows. You can define a transaction based on a varying number of input rows. You might want to define transactions based on a group of rows ordered on a common key, such as employee ID or order entry date.

In PowerCenter, you define transaction control at the following levels:

- **Within a mapping.** Within a mapping, you use the Transaction Control transformation to define a transaction. You define transactions using an expression in a Transaction Control transformation. Based on the return value of the expression, you can choose to commit, roll back, or continue without any transaction changes.
- **Within a session.** When you configure a session, you configure it for user-defined commit. You can choose to commit or roll back a transaction if the Integration Service fails to transform or write any row to the target.

When you run the session, the Integration Service evaluates the expression for each row that enters the transformation. When it evaluates a commit row, it commits all rows in the transaction to the target or targets. When the Integration Service evaluates a roll back row, it rolls back all rows in the transaction from the target or targets.

If the mapping has a flat file target you can generate an output file each time the Integration Service starts a new transaction. You can dynamically name each target flat file.

Note: You can also use the transformation scope in other transformation properties to define transactions.

Transaction Control Transformation Properties

Use the Transaction Control transformation to define conditions to commit and roll back transactions from transactional targets. Transactional targets include relational, XML, and dynamic MQSeries targets. Define these parameters in a transaction control expression on the Properties tab. A transaction is the row or set of rows bound by commit or roll back rows. The number of rows may vary for each transaction.

When you configure a Transaction Control transformation, you define the following components:

- **Transformation tab.** You can rename the transformation and add a description on the Transformation tab.
- **Ports tab.** You can add input/output ports to a Transaction Control transformation.
- **Properties tab.** You can define the transaction control expression, which flags transactions for commit, roll back, or no action.
- **Metadata Extensions tab.** You can extend the metadata stored in the repository by associating information with the Transaction Control transformation.

Properties Tab

On the Properties tab, you can configure the following properties:

- Transaction control expression
- Tracing level

Enter the transaction control expression in the Transaction Control Condition field. The transaction control expression uses the IIF function to test each row against the condition. Use the following syntax for the expression:

```
IIF (condition, value1, value2)
```

The expression contains values that represent actions the Integration Service performs based on the return value of the condition. The Integration Service evaluates the condition on a row-by-row basis. The return value determines whether the Integration Service commits, rolls back, or makes no transaction changes to the row. When the Integration Service issues a commit or roll back based on the return value of the expression, it begins a new transaction. Use the following built-in variables in the Expression Editor when you create a transaction control expression:

- **TC_CONTINUE_TRANSACTION.** The Integration Service does not perform any transaction change for this row. This is the default value of the expression.
- **TC_COMMIT_BEFORE.** The Integration Service commits the transaction, begins a new transaction, and writes the current row to the target. The current row is in the new transaction.
- **TC_COMMIT_AFTER.** The Integration Service writes the current row to the target, commits the transaction, and begins a new transaction. The current row is in the committed transaction.
- **TC_ROLLBACK_BEFORE.** The Integration Service rolls back the current transaction, begins a new transaction, and writes the current row to the target. The current row is in the new transaction.
- **TC_ROLLBACK_AFTER.** The Integration Service writes the current row to the target, rolls back the transaction, and begins a new transaction. The current row is in the rolled back transaction.

If the transaction control expression evaluates to a value other than commit, roll back, or continue, the Integration Service fails the session.

Example

You want to use transaction control to write order information based on the order entry date. You want to ensure that all orders entered on any given date are committed to the target in the same transaction. To accomplish this, you can create a mapping with the following transformations:

- **Sorter transformation.** Sort the source data by order entry date.
- **Expression transformation.** Use local variables to determine whether the date entered is a new date.

The following table describes the ports in the Expression transformation:

Port Name	Expression	Description
DATE_ENTERED	DATE_ENTERED	Input/Output port. Receives and passes the date entered.
NEW_DATE	IIF(DATE_ENTERED=PREVDATE, 0,1)	Variable port. Tests current value for DATE_ENTERED against the stored value for DATE_ENTERED in the variable port, PREV_DATE.
PREV_DATE	DATE_ENTERED	Variable port. Receives the value for DATE_ENTERED after the Integration Service evaluates the NEW_DATE port.
DATE_OUT	NEW_DATE	Output port. Passes the flag from NEW_DATE to the Transaction Control transformation.

Note: The Integration Service evaluates ports by dependency. The order in which ports display in a transformation must match the order of evaluation: input ports, variable ports, output ports.

- **Transaction Control transformation.** Create the following transaction control expression to commit data when the Integration Service encounters a new order entry date:

```
IIF(NEW_DATE = 1, TC_COMMIT_BEFORE, TC_CONTINUE_TRANSACTION)
```

The following figure shows a sample mapping using a Transaction Control transformation:

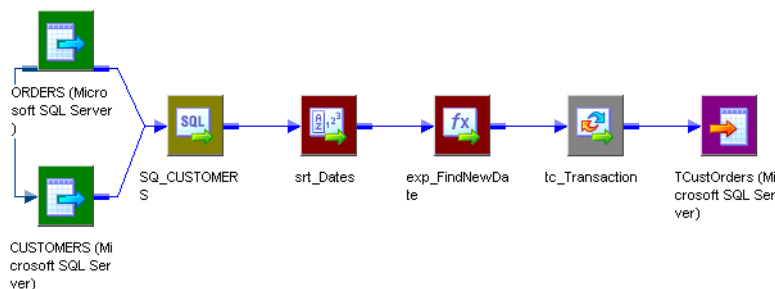

Using Transaction Control Transformations in Mappings

Transaction Control transformations are transaction generators. They define and redefine transaction boundaries in a mapping. They drop any incoming transaction boundary from an upstream active source or transaction generator, and they generate new transaction boundaries downstream.

You can also use Custom transformations configured to generate transactions to define transaction boundaries.

Transaction Control transformations can be effective or ineffective for the downstream transformations and targets in the mapping. The Transaction Control transformation becomes ineffective for downstream transformations or targets if you put a transformation that drops incoming transaction boundaries after it. This includes any of the following active sources or transformations:

- Aggregator transformation with the All Input level transformation scope
- Joiner transformation with the All Input level transformation scope
- Rank transformation with the All Input level transformation scope
- Sorter transformation with the All Input level transformation scope
- Custom transformation with the All Input level transformation scope
- Custom transformation configured to generate transactions
- Transaction Control transformation
- A multiple input group transformation, such as a Custom transformation, connected to multiple upstream transaction control points

Mappings with Transaction Control transformations that are ineffective for targets may be valid or invalid. When you save or validate the mapping, the Designer displays a message indicating which Transaction Control transformations are ineffective for targets.

Although a Transaction Control transformation may be ineffective for a target, it can be effective for downstream transformations. Downstream transformations with the Transaction level transformation scope can use the transaction boundaries defined by an upstream Transaction Control transformation.

The following figure shows a valid mapping with a Transaction Control transformation that is effective for a Sorter transformation, but ineffective for the target.

In this example, TCT1 transformation is ineffective for the target, but effective for the Sorter transformation. The Sorter transformation Transformation Scope property is Transaction. It uses the transaction boundaries defined by TCT1. The Aggregator Transformation Scope property is All Input. It drops transaction boundaries defined by TCT1. The TCT2 transformation is an effective Transaction Control transformation for the target.

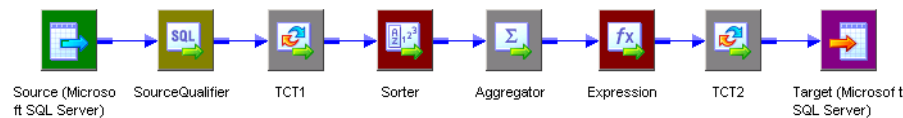

Sample Transaction Control Mappings with Multiple Targets

A Transaction Control transformation may be effective for one target and ineffective for another target.

If each target is connected to an effective Transaction Control transformation, the mapping is valid. If one target in the mapping is not connected to an effective Transaction Control transformation, the mapping is invalid.

The following figure shows a valid mapping with both an ineffective and an effective Transaction Control transformation:

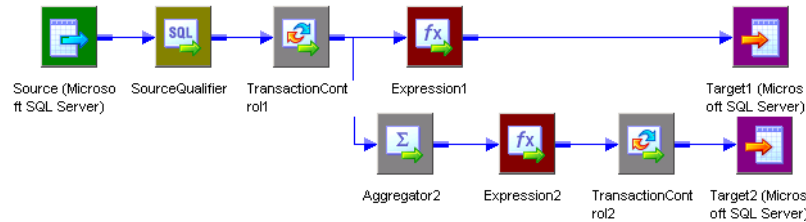

The Integration Service processes TransactionControl1, evaluates the transaction control expression, and creates transaction boundaries. The mapping does not include any transformation that drops transaction boundaries between TransactionControl1 and Target1, making TransactionControl1 effective for Target1. The Integration Service uses the transaction boundaries defined by TransactionControl1 for Target1.

However, the mapping includes a transformation that drops transaction boundaries between TransactionControl1 and Target2, making TransactionControl1 ineffective for Target2. When the Integration Service processes Aggregator2, with Transformation Scope set to All Input, it drops the transaction boundaries defined by TransactionControl1 and outputs all rows in an open transaction. Then the Integration Service evaluates TransactionControl2, creates transaction boundaries, and uses them for Target2.

If a roll back occurs in TransactionControl1, the Integration Service rolls back only rows from Target1. It does not roll back any rows from Target2.

The following figure shows an invalid mapping with both an ineffective and an effective Transaction Control transformation:

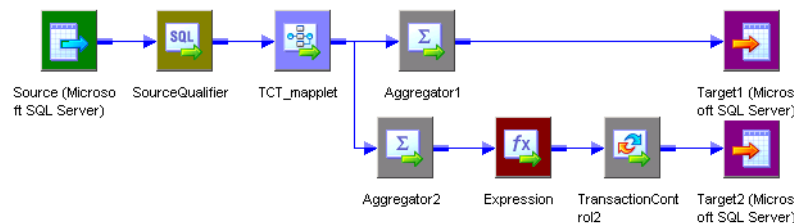

The maplet, TCT_mapplet, contains a Transaction Control transformation. It is ineffective for Target1 and Target2. The Aggregator1 transformation Transformation Scope property is All Input. It is an active source for Target1. The Aggregator2 transformation Transformation Scope property is All Input. It is an active source for Target2. The TransactionControl2 transformation is effective for Target2.

The mapping is invalid because Target1 is not connected to an effective Transaction Control transformation.

Mapping Guidelines and Validation

Use the following rules and guidelines when you create a mapping with a Transaction Control transformation:

- If the mapping includes an XML target, and you choose to append or create a new document on commit, the input groups must receive data from the same transaction control point.
- Transaction Control transformations connected to any target other than relational, XML, or dynamic MQSeries targets are ineffective for those targets.
- You must connect each target instance to a Transaction Control transformation.

- You can connect multiple targets to a single Transaction Control transformation.
- You can connect only one effective Transaction Control transformation to a target.
- You cannot place a Transaction Control transformation in a pipeline branch that starts with a Sequence Generator transformation.
- If you use a dynamic Lookup transformation and a Transaction Control transformation in the same mapping, a rolled-back transaction might result in unsynchronized target data.
- A Transaction Control transformation may be effective for one target and ineffective for another target. If each target is connected to an effective Transaction Control transformation, the mapping is valid.
- Either all targets or none of the targets in the mapping should be connected to an effective Transaction Control transformation.

Creating a Transaction Control Transformation

Use the following procedure to add a Transaction Control transformation to a mapping:

1. In the Mapping Designer, click Transformation > Create. Select the Transaction Control transformation.
2. Enter a name for the transformation.
The naming convention for Transaction Control transformations is *TC_TransformationName*.
3. Enter a description for the transformation.
This description appears when you view transformation details in the Repository Manager, making it easier to understand what the transformation does.
4. Click Create.
The Designer creates the Transaction Control transformation.
5. Click Done.
6. Drag the ports into the transformation.
The Designer creates the input/output ports for each port you include.
7. Open the Edit Transformations dialog box, and select the Ports tab.
You can add ports, edit port names, add port descriptions, and enter default values.
8. Select the Properties tab. Enter the transaction control expression that defines the commit and roll back behavior.
9. Select the Metadata Extensions tab. Create or edit metadata extensions for the Transaction Control transformation.
10. Click OK.

CHAPTER 30

Union Transformation

This chapter includes the following topics:

- [Union Transformation Overview, 464](#)
- [Working with Groups and Ports, 465](#)
- [Creating a Union Transformation, 465](#)
- [Using a Union Transformation in a Mapping, 466](#)

Union Transformation Overview

The Union transformation is a multiple input group transformation that you use to merge data from multiple pipelines or pipeline branches into one pipeline branch. It merges data from multiple sources similar to the UNION ALL SQL statement to combine the results from two or more SQL statements. Similar to the UNION ALL statement, the Union transformation does not remove duplicate rows. The Union transformation is an active transformation.

The Data Integration Service processes all input groups in parallel. It concurrently reads sources connected to the Union transformation and pushes blocks of data into the input groups of the transformation. The Union transformation processes the blocks of data based on the order it receives the blocks from the Integration Service.

You can connect heterogeneous sources to a Union transformation. The transformation merges sources with matching ports and outputs the data from one output group with the same ports as the input groups.

The Union transformation is developed using the Custom transformation.

Rules and Guidelines for Union Transformations

Use the following rules and guidelines when you work with a Union transformation:

- You can create multiple input groups, but only one output group.
- All input groups and the output group must have matching ports. The precision, datatype, and scale must be identical across all groups.
- The Union transformation does not remove duplicate rows. To remove duplicate rows, you must add another transformation such as a Router or Filter transformation.
- The Union transformation does not generate transactions.

Union Transformation Components

When you configure a Union transformation, define the following components:

- **Transformation tab.** You can rename the transformation and add a description.
- **Properties tab.** You can specify the tracing level.
- **Groups tab.** You can create and delete input groups. The Designer displays groups you create on the Ports tab.
- **Group Ports tab.** You can create and delete ports for the input groups. The Designer displays ports you create on the Ports tab.

You cannot modify the Ports tab in a Union transformation.

Working with Groups and Ports

A Union transformation has multiple input groups and one output group. Create input groups on the Groups tab, and create ports on the Group Ports tab.

You can create one or more input groups on the Groups tab. The Designer creates one output group by default. You cannot edit or delete the output group.

You can create ports by copying ports from a transformation, or you can create ports manually. When you create ports on the Group Ports tab, the Designer creates input ports in each input group and output ports in the output group. The Designer uses the port names you specify on the Group Ports tab for each input and output port, and it appends a number to make each port name in the transformation unique. It also uses the same metadata for each port, such as datatype, precision, and scale.

The Ports tab displays the groups and ports you create. You cannot edit group and port information on the Ports tab. Use the Groups and Group Ports tab to edit groups and ports.

Creating a Union Transformation

Use the following procedure to create a Union transformation:

1. In the Mapping Designer, click Transformations > Create.
2. Select Union Transformation and enter the name of the transformation.
The naming convention for Union transformations is `UN_TransformationName`.
3. Enter a description for the transformation. Click Create, and then click Done.
4. Click the Groups tab.
5. Add an input group for each pipeline or pipeline branch you want to merge.
The Designer assigns a default name for each group but they can be renamed.
6. Click the Group Ports tab.
7. Add a new port for each row of data you want to merge.
8. Enter port properties, such as name and datatype.
9. Click the Properties tab to configure the tracing level.
10. Click OK.

Using a Union Transformation in a Mapping

The Union transformation is a non-blocking multiple input group transformation. You can connect the input groups to different branches in a single pipeline or to different source pipelines.

When you add a Union transformation to a mapping, you must verify that you connect the same ports in all input groups. If you connect all ports in one input group, but do not connect a port in another input group, the Integration Service passes NULLs to the unconnected port.

The following figure shows a mapping with a Union transformation:

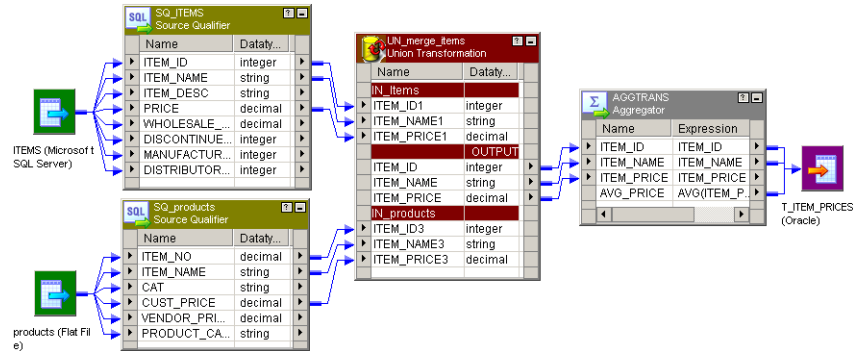

When a Union transformation in a mapping receives data from a single transaction generator, the Integration Service propagates transaction boundaries. When the transformation receives data from multiple transaction generators, the Integration Service drops all incoming transaction boundaries and outputs rows in an open transaction.

CHAPTER 31

Unstructured Data Transformation

This chapter includes the following topics:

- [Unstructured Data Transformation Overview, 467](#)
- [Configuring the Unstructured Data Option, 468](#)
- [Data Transformation Service Types, 469](#)
- [Unstructured Data Transformation Components, 469](#)
- [Unstructured Data Transformation Ports, 472](#)
- [Unstructured Data Transformation Service Names, 474](#)
- [Relational Hierarchies, 475](#)
- [Mappings, 476](#)
- [Creating an Unstructured Data Transformation, 478](#)

Unstructured Data Transformation Overview

The Unstructured Data transformation is a transformation that processes unstructured and semi-structured file formats, such as messaging formats, HTML pages and PDF documents. It also transforms structured formats such as ACORD, HIPAA, HL7, EDI-X12, EDIFACT, and SWIFT.

The Unstructured Data transformation calls a Data Transformation service from a PowerCenter session. Data Transformation is the application that transforms the unstructured and semi-structured file formats. You can pass data from the Unstructured Data transformation to a Data Transformation service, transform the data, and return the transformed data to the pipeline. The Unstructured Data transformation can be an active or passive transformation.

Data Transformation has the following components:

- Informatica Developer. A development tool that provides capability to design and configure transformation projects.
- Data Transformation service. A Data Transformation project that is deployed to the Data Transformation repository and is ready to run.
- Data Transformation repository. A directory that stores executable services that you create in Informatica Developer. You can deploy projects to different repositories, such as repositories for test and production services.
- Data Transformation Engine. A processor that runs the services that you deploy to the repository.

When Data Transformation Engine runs a service, it writes the output data, or it returns output data to the Integration Service. When Data Transformation Engine returns output to the Integration Service, it returns XML data. You can configure the Unstructured Data transformation to return the XML in an output port, or you can configure output groups to return row data.

The following figure shows the interface between the PowerCenter Unstructured Data transformation and a Data Transformation service that transforms data from a PowerCenter session:

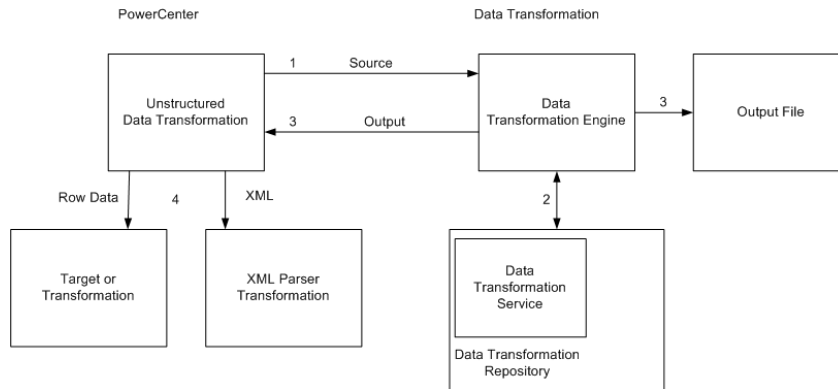

The following events occur when you call a Data Transformation service from a PowerCenter session:

1. The Unstructured Data transformation passes source data to Data Transformation Engine.
2. Data Transformation Engine runs a Data Transformation service to transform the data. The Data Transformation service is in the Data Transformation repository folder.
3. Data Transformation Engine writes transformed data directly to output files, or it returns the transformed data to the Unstructured Data transformation.
4. The Unstructured Data transformation returns XML data or data rows. If the Unstructured Data transformation returns XML, connect the Unstructured Data transformation to an XML Parser transformation in the mapping.

Configuring the Unstructured Data Option

The Unstructured Data transformation is installed with PowerCenter. Data Transformation has a separate installer. Install the Data Transformation Server and Client components after you install PowerCenter.

To install the Unstructured Data option, complete the following steps:

1. Install PowerCenter.
2. Install Data Transformation.

When you install Data Transformation you are prompted to select a Java Runtime Environment. At the prompt, browse to the JRE that is used by PowerCenter.

By default, the setup configures Data Transformation Engine to run in-process. To use Data Transformation with the Unstructured Data transformation, do not configure Data Transformation to run out-of-process.

3. Configure the Data Transformation repository folder.

Configuring the Data Transformation Repository Directory

The Data Transformation repository contains executable Data Transformation services. When you install Data Transformation, the installer creates the repository in the following folder:

```
<Data_Transformation_install_dir>\DataTransformation\ServiceDB
```

To configure a different repository folder location, open Data Transformation Configuration from the Start menu. The repository location is in the following path in the Data Transformation configuration:

CM Configuration > CM Repository > File System > Base Path

If Informatica Developer can access the remote file system, you can change the Data Transformation repository to a remote location and deploy services directly from Informatica Developer to the system that runs the Integration Service.

Copy custom files from the <Data_Transformation_install_dir>\DataTransformation\autoInclude\user directory and the <Data_Transformation_install_dir>\DataTransformation\externLibs\user directory to the same directories on the node that runs the Integration Service.

Data Transformation Service Types

When you create a Data Processor transformation in Informatica Developer, you choose an object or component to define the transformation service type. Data Transformation has the following types of services that transform data:

- **Parser.** Converts source documents to XML or JSON. The output of a parser is always XML. The input can have any format, such as text, HTML, Word, PDF, or HL7.
- **Serializer.** Converts an XML or JSON file to an output document of any format. The output of a serializer can be any format, such as a text document, an HTML document, or a PDF.
- **Mapper and XMap.** Converts an XML or JSON source document to another XML or JSON structure. A mapper processes the input similarly to a serializer. It generates output similarly to a parser. The input and the output are fully structured XML or JSON.
- **Transformer.** Modifies the data in any format. Adds, removes, converts, or changes text. Use transformers with a parser, mapper, or serializer. You can also run a transformer as stand-alone component.
- **Streamer.** Splits large input documents, such as multi-gigabyte data streams, into segments. The streamer processes documents that have multiple messages or records in them, such as HIPAA or EDI files.

Unstructured Data Transformation Components

The Unstructured Data transformation contains the following tabs:

- **Transformation.** Enter the name and description of the transformation. The naming convention for an Unstructured Data transformation is UD_TransformationName. You can also make the Unstructured Data transformation reusable.
- **Properties.** Configure the Unstructured Data transformation general properties such as IsPartitionable and Output is Repeatable.

- UDT Settings. Modify Unstructured Data transformation settings such as input type, output type, and service name.
- UDT Ports. Configure Unstructured Data transformation ports and attributes.
- Input Hierarchy. Define a hierarchy of input groups and ports to enable the Unstructured Data transformation to read rows of data.
- Output Hierarchy. Define a hierarchy of output groups and ports to enable the Unstructured Data transformation to write rows to relational targets.

Properties Tab

Configure the Unstructured Data transformation general properties on the **Properties** tab.

The following table describes properties on the **Properties** tab that you can configure:

Property	Description
Tracing Level	The amount of detail included in the session log when you run a session containing this transformation. Default is Normal.
IsPartitionable	The transformation can run in more than one partition. Select one of the following options: <ul style="list-style-type: none"> - No. The transformation cannot be partitioned. - Locally. The transformation can be partitioned, but the Integration Service must run all partitions in the pipeline on the same node. - Across Grid. The transformation can be partitioned, and the Integration Service can distribute each partition to different nodes. Default is Across Grid.
Output is Repeatable	The order of the output data is consistent between session runs. <ul style="list-style-type: none"> - Never. The order of the output data is inconsistent between session runs. - Based On Input Order. The output order is consistent between session runs when the input data order is consistent between session runs. - Always. The order of the output data is consistent between session runs even if the order of the input data is inconsistent between session runs. Default is Never for active transformations. Default is Based On Input Order for passive transformation runs.
Output is Deterministic	Indicates whether the transformation generates consistent output data between session runs. Enable this property to perform recovery on sessions that use this transformation.

Warning: If you configure a transformation as repeatable and deterministic, it is your responsibility to ensure that the data is repeatable and deterministic. If you try to recover a session with transformations that do not produce the same data between the session and the recovery, the recovery process can result in corrupted data.

UDT Settings Tab

Configure the Unstructured Data transformation attributes on the **UDT Settings** tab.

The following table describes the attributes on the **UDT settings** tab:

Attribute	Description
InputType	Type of input data that the Unstructured Data transformation passes to Data Transformation Engine. Choose one of the following input types: <ul style="list-style-type: none"> - Buffer. The Unstructured Data transformation receives source data in the InputBuffer port and passes data from the port to Data Transformation Engine. - File. The Unstructured Data transformation receives a source file path in the InputBuffer port and passes the source file path to Data Transformation Engine. Data Transformation Engine opens the source file.
OutputType	Type of output data that the Unstructured Data transformation or Data Transformation Engine returns. Choose one of the following output types: <ul style="list-style-type: none"> - Buffer. The Unstructured Data transformation returns XML data through the OutputBuffer port unless you configure a relational hierarchy of output ports. If you configure a relational hierarchy of ports, the Unstructured Data transformation does not write to the OutputBuffer port. - File. Data Transformation Engine writes the output to a file. It does not return the data to the Unstructured Data transformation unless you configure a relational hierarchy of ports in the Unstructured Data transformation. - Splitting. The Unstructured Data transformation splits a large XML output file into smaller files that can fit in the OutputBuffer port. You must pass the split XML files to the XML Parser transformation.
ServiceName	Name of the Data Transformation service to run. The service must be present in the local Data Transformation repository.
Streamer Chunk Size	Buffer size of the data that the Unstructured Data transformation passes to Data Transformation Engine when the Data Transformation service runs a streamer. Valid values are 1-1,000,000 KB. Default is 256 KB.
Dynamic Service Name	Run a different Data Transformation service for each input row. When Dynamic Service Name is enabled, the Unstructured Data transformation receives the service name in the Service Name input port. When Dynamic Service name is disabled, the Unstructured Data transformation runs the same service for each input row. The Service Name attribute in the UDT Settings must contain a service name. Default is disabled.
Status Tracing Level	Set the level of status messages from the Data Transformation service. <ul style="list-style-type: none"> - Description Only. Return a status code and a short description to indicate if the Data Transformation service was successful or if it failed. - Full Status. Return a status code and a status message from the Data Transformation service in XML. - None. Do not return status from the Data Transformation service. Default is none.
Allow Input Flush	Enable Allow Input Flush when you configure input groups of ports. The Unstructured Data transformation creates XML when it has all the data for a group. Configure the mapping so the transformation receives data that is sorted by group. When input flush is not enabled, the Unstructured Data transformation stores the data in memory and creates the XML after it receives data for all the groups.

Viewing Status Tracing Messages

You can view status messages from the Data Transformation service. Set the status tracing level to Description Only or Full Status. The Designer creates the UDT_Status_Code port and the UDT_Status_Message output ports in the Unstructured Data transformation.

When you choose Description Only, Data Transformation Engine returns a status code and one of the following status messages:

Status Code	Status Message
1	Success
2	Warning
3	Failure
4	Error
5	Fatal Error

When you choose Full Status, Data Transformation Engine returns a status code and the error message from the Data Transformation service. The message is in XML format.

Unstructured Data Transformation Ports

When you create an Unstructured Data transformation, the Designer creates default ports. It creates other ports based on how you configure the transformation. The Unstructured Data transformation input and output types determine how the Unstructured Data transformation passes data to and receives data from Data Transformation Engine.

The following table describes the Unstructured Data transformation default ports:

Port	Input/ Output	Description
InputBuffer	Input	Receives source data when the input type is buffer. Receives a source file name and path when the input type is file.
OutputBuffer	Output	Returns XML data when the output type is buffer. Returns the output file name when the output type is file. Returns no data when you configure hierarchical output groups of ports.

The following table describes other Unstructured Data transformation ports that the Designer creates when you configure the transformation:

Port	Input/Output	Description
OutputFileName	Input	Receives a name for an output file when the output type is file.
ServiceName	Input	Receives the name of a Data Transformation service when you enable Dynamic Service Name.
UDT_Status_Code	Output	Returns a status code from Data Transformation Engine when the status tracing level is Description Only or Full Status.
UDT_Status_Message	Output	Returns a status message from Data Transformation Engine when the status tracing level is Description Only or Full Status.

Note: You can add groups of output ports for relational targets on the **Input** or **Output Hierarchy** tabs. When you configure groups of ports, a message appears on the **UDT Ports** tab that says hierarchical groups and ports are defined on another tab.

Input and Output Types

The input type determines the type of data that the Integration Service passes to Data Transformation Engine. The input type determines whether the input is data or a source file path.

Configure one of the following input types:

- **Buffer.** The Unstructured Data transformation receives source data in the InputBuffer port. The Integration Service passes source rows from the InputBuffer port to Data Transformation Engine.
- **File.** The Unstructured Data transformation receives the source file path in the InputBuffer port. The Integration Service passes the source file path to Data Transformation Engine. Data Transformation Engine opens the source file. Use the File input type to parse binary files such as Microsoft Excel or Microsoft Word files.

If you do not define output groups and ports, the Unstructured Data transformation returns data based on the output type.

Configure one of the following output types:

- **Buffer.** The Unstructured Data transformation returns XML through the Outputbuffer port. You must connect an XML Parser transformation to the Outputbuffer port.
- **File.** Data Transformation Engine writes the output file instead of passing data to the Integration Service. Data Transformation Engine names the output file based on the file name from the OutputFilename port. Choose the File output type to transform XML to binary data such as a PDF file or a Microsoft Excel file.
The Integration Service returns the output file name in the OutputBuffer port for each source row. If the output file name is blank, the Integration Service returns a row error. When an error occurs, the Integration Service writes a null value to the OutputBuffer and returns a row error.
- **Splitting.** The Unstructured Data transformation splits XML data from Data Transformation Engine into multiple segments. Choose the Splitting output type when the Unstructured Data transformation returns XML files that are too large for the OutputBuffer port. When you configure Splitting output, pass the XML data to the XML Parser transformation. Configure the XML Parser transformation to process the multiple XML rows as one XML file.

Additional Unstructured Data Transformation Ports

A Data Transformation service might require multiple input files, file names, and parameters. It can return multiple output files. When you create an Unstructured Data transformation, the Designer creates one InputBuffer port and one OutputBuffer port. If you need to pass additional files or file names between the Unstructured Data transformation and Data Transformation Engine, add the input or output ports. You can add ports manually or from the Data Transformation service.

The following table describes the ports you can create on the **UDT Ports** tab:

Port Type	Input/ Output	Description
Additional Input (buffer)	Input	Receives input data to pass to Data Transformation Engine.
Additional Input (file)	Input	Receives the file name and path for Data Transformation Engine to open.
Service Parameter	Input	Receives an input parameter for a Data Transformation service.
Additional Output (buffer)	Output	Receives XML data from Data Transformation Engine.
Additional Output (file)	Output	Receives an output file name from Data Transformation Engine.
Pass-through	Input/ Output	Passes data through the Unstructured Data transformation without changing it.

Creating Ports From a Data Transformation Service

A Data Transformation service can require input parameters, additional input files, or user-defined variables. The service might return more than one output file to the Unstructured Data transformation. You can add ports that pass parameters, additional input files, and additional output files. The Designer creates ports that correspond to the ports in the Data Transformation service.

Note: You must configure a service name to populate ports from a service.

1. Click the **Ports** tab on the Unstructured Data transformation.
2. Click **Populate From Service**.
The Designer displays the service parameters, additional input port, and additional output port requirements from the Data Transformation service. Service parameters include Data Transformation system variables and user-defined variables.
3. Select the ports to create and configure each port as a buffer port or file port.
4. Click **Populate** to create the ports that you select. You can select all ports that appear.

Unstructured Data Transformation Service Names

When you create an Unstructured Data transformation, the Designer displays a list of the Data Transformation services that are in the Data Transformation repository. Choose the name of a Data Transformation service that you want to call from the Unstructured Data transformation. You can change the service name after you create the transformation. The service name appears on the **UDT Settings** tab.

To run a different Data Transformation service for each source row, enable the Dynamic Service Name attribute. Pass the service name with each source row. The Designer creates the ServiceName input port when you enable dynamic service names.

When you enable dynamic service names, you cannot create ports from a Data Transformation service.

When you define a relational structure of input ports, you cannot enable dynamic service names. Each Data Transformation service might require different input data.

Relational Hierarchies

You can define groups of ports and define a relational structure for the groups. To build a hierarchy of input ports, configure ports on the **Input Hierarchy** tab. To pass row data to relational tables or other targets, configure output ports on the **Output Hierarchy** tab.

When you define a relational structure of input ports, the Unstructured Data transformation generates XML to pass to a Data Transformation service. To increase performance, enable the PowerCenter Integration Service to flush XML to the Unstructured Data transformation. When you enable input flushing, the PowerCenter Integration Service flushes XML from each group after it receives all the data for the root value. For example, you have an employee group and an employee address group. The PowerCenter Integration Service can flush data from both groups to the Unstructured Data transformation each time a different employee occurs in the data. You must sort the data in each group by the primary key of the root group. You can join groups in the pipeline if a group does not have the same key.

When you configure output groups, the output groups represent the relational tables or the targets that you want to pass the output data to. Data Transformation Engine returns rows to the group ports instead of writing an XML file to the OutputBuffer port. The transformation writes rows based on the output type.

Create a hierarchy of groups in the left pane of the **Output Hierarchy** tab. All groups are under the root group. You cannot delete the root. Each group can contain ports and other groups. The group structure represents the relationship between target tables. When you define a group within a group, you define a parent-child relationship between the groups. The Designer defines a primary key-foreign key relationship between the groups with a generated key.

Select a group to display the ports for the group. You can add or delete ports in the group. When you add a port, the Designer creates a default port configuration. Change the port name, datatype, and precision. If the port must contain data, select Not Null. Otherwise, the output data is optional.

When you view the Unstructured Data transformation in the workspace, each port in a transformation group has a prefix that contains the group name.

When you delete a group, you delete the ports in the group and the child groups.

Exporting the Hierarchy Schema

When you define hierarchical output groups in the Unstructured Data transformation, you must define the same structure in the Data Transformation service that you create to transform the data. Export the hierarchy structure as an XML schema file from the Unstructured Data transformation. Import the schema to your Data Processor transformation. You can then map the content of a source document to the XML elements and attributes in the Data Processor transformation.

To export the group hierarchy from the **Relational Hierarchy** tab, click **Export to XML Schema**. Choose a name and a location for the XSD file. Choose a location that you can access when you import the schema with Information Developer.

The Designer creates a schema with the following namespace:

```
"www.informatica.com/UDT/XSD/<mappingName_<Transformation_Name>>"
```

The schema includes the following comment:

```
<!-- ===== AUTO-GENERATED FILE - DO NOT EDIT ===== -->  
<!-- ===== This file has been generated by Informatica PowerCenter ===== -->
```

If you modify the schema, Data Transformation Engine might return data that is not the same format as the output ports in the Unstructured Data transformation.

The XML elements in the schema represent the output ports in the hierarchy. Columns that can contain null values have a `minOccurs=0` and `maxOccurs=1` XML attribute.

Mappings

When you create a mapping, design it according to the type of Data Transformation service you are going to run. For example, the Data Transformation parser and mapper generate XML data. You can configure the Unstructured Data transformation to return rows from the XML data or you can configure it to return an XML file.

The Data Transformation serializer component can generate any output from XML. It can generate HTML or binary files such as Microsoft Word or Microsoft Excel. When the output is binary data, Data Transformation Engine writes the output to a file instead of passing it back to the Unstructured Data transformation.

The following examples show how to configure mappings with an Unstructured Data transformation.

Parsing Word Documents for Relational Tables

You can extract order information from a Microsoft Word document and write the order information to an order header table and an order detail table. Configure an Unstructured Data transformation to call a Data Transformation parser service and pass the name of each Word document to parse. Data Transformation Engine opens the Word document, parses it, and returns the rows to the Unstructured Data transformation. The Unstructured Data transformation passes the order header and order details to the relational targets.

The mapping has the following objects:

- Source Qualifier transformation. Passes each Microsoft Word file name to the Unstructured Data transformation. The source file name contains the complete path to the file that contains order information.
- Unstructured Data transformation. The input type is file. The output type is buffer. The transformation contains an order header output group and an order detail output group. The groups have a primary key-foreign key relationship.

The Unstructured Data transformation receives the source file name in the InputBuffer port. It passes the name to Data Transformation Engine. Data Transformation Engine runs a parser service to extract the order header and order detail rows from the Word document. Data Transformation Engine returns the data to the Unstructured Data transformation. The Unstructured Data transformation passes data from the order header group and order detail group to the relational targets.

- Relational targets. Receive the rows from the Unstructured Data transformation.

Creating an Excel Sheet from XML

You can extract employee names and addresses from an XML file and create a Microsoft Excel sheet with the list of names.

The mapping has the following components:

- XML source file. Contains employee names and addresses.
- Source Qualifier transformation. Passes XML data and an output file name to the Unstructured Data transformation. The XML file contains employee names.
- Unstructured Data transformation. The input type is buffer and the output type is file. The Unstructured Data transformation receives the XML data in the InputBuffer port and the file name in the OutputFileName port. It passes the XML data and the file name to Data Transformation Engine.

Data Transformation Engine runs a serializer service to transform the XML data to a Microsoft Excel file. It writes the Excel file with a file name based on the value of OutputFilename.

The Unstructured Data transformation receives only the output file name from Data Transformation Engine. The Unstructured Data transformation OutputBuffer port returns the value of OutputFilename.

- Flat file target. Receives the output file name.

Split XML File Output

The Data Transformation parser and mapper components can transform data from any format and generate XML data. When the XML data is large, you can split the XML into segments and pass the segments to an XML Parser transformation. The XML Parser transformation receives the segments and processes the XML data as one document.

When you configure the Unstructured Data transformation to split XML output, the Unstructured Data transformation returns XML based on the OutputBuffer port size. If the XML file size is greater than the output port precision, the Integration Service divides the XML into files equal to or less than the port size. The XML Parser transformation parses the XML and passes the rows to relational tables or other targets.

For example, you can extract the order header and detail information from Microsoft Word documents with a Data Transformation parser service.

The mapping has the following components:

- Source Qualifier transformation. Passes the Word document file name to the Unstructured Data transformation. The source file name contains the complete path to the file that contains order information.
- Unstructured Data transformation. The input type is file. The output type is splitting. The Unstructured Data transformation receives the source file name in the InputBuffer port. It passes the file name to Data Transformation Engine. Data Transformation Engine opens the source file, parses it, and returns XML data to the Unstructured Data transformation.

The Unstructured Data transformation receives the XML data, splits the XML file into smaller files, and passes the segments to an XML Parser transformation. The Unstructured Data transformation returns data in segments less than the OutputBuffer port size. When the transformation returns XML data in multiple segments, it generates the same pass-through data for each row. The Unstructured Data transformation returns data in pass-through ports when a row is successful or not successful.

- XML Parser transformation. The Enable Input Streaming session property is enabled. The XML Parser transformation receives the XML data in the DataInput port. The input data is split into segments. The XML Parser transformation parses the XML data into order header and detail rows. It passes order header and detail rows to relational targets. It returns the pass-through data to a Filter transformation.
- Filter transformation. Removes the duplicate pass-through data before passing it to the relational targets.

- Relational targets. Receive data from each group in the XML Parser transformation and the Filter transformation.

Rules and Guidelines for Unstructured Data Mappings

Use the following rules and guidelines when you create an unstructured data mapping:

- When you configure hierarchical groups of output ports, the Integration Service writes to the groups of ports instead of writing to the OutputBuffer port. The Integration Service writes to the groups of ports regardless of the output type you define for the transformation.
- If an Unstructured Data transformation has the File output type, and you have not defined group output ports, you must link the OutputBuffer port to a downstream transformation. Otherwise, the mapping is invalid. The OutputBuffer port contains the output file name when the Data Transformation service writes the output file.
- Enable Dynamic Service Name to pass a service name to the Unstructured Data transformation in the Service Name input port. When you enable Dynamic Service Name, the Designer creates the Service Name input port.
- You must configure a service name with the Unstructured Data transformation or enable the Dynamic Service Name option. Otherwise the mapping is invalid.
- Link XML output from the Unstructured Data transformation to an XML Parser transformation.

Creating an Unstructured Data Transformation

Use the PowerCenter Transformation Developer or the Mapping Designer to create an Unstructured Data transformation.

1. In the Mapping Designer or Transformation Developer, click **Transformation > Create**.
2. Select **Unstructured Data Transformation** as the transformation type.
3. Enter a name for the transformation.
4. Click **Create**.

The **Unstructured Data Transformation** dialog box appears.

5. Configure the following properties:

Property	Description
Service Name	Name of the Data Transformation service you want to use. The Designer displays the Data Transformation services in the Data Transformation repository folder. Do not choose a name if you plan to enable dynamic service names. You can add a service name on the UDT Settings tab after you create the transformation.
Input Type	Describes how Data Transformation Engine receives input data. Default is Buffer.
Output Type	Describes how Data Transformation Engine returns output data. Default is Buffer.

6. Click **OK**.
7. You can change the service name, input, and output type on the **UDT Settings** tab.

8. Configure the Unstructured Data transformation properties on the **Properties** tab.
9. If the Data Transformation service has more than one input or output file, or if it requires input parameters, you can add ports on the **UDT Ports** tab. You can also add pass-through ports on the **Ports** tab.
10. If you want to return row data from the Unstructured Data transformation instead of XML data, create groups of output ports on the **Relational Hierarchy** tab.
11. If you create groups of ports, export the schema that describes them from the **Relational Hierarchy** tab.
12. Import the schema to the Data Transformation project to define the project output.

CHAPTER 32

Update Strategy Transformation

This chapter includes the following topics:

- [Update Strategy Transformation Overview, 480](#)
- [Flagging Rows Within a Mapping, 481](#)
- [Setting the Update Strategy for a Session, 483](#)
- [Update Strategy Checklist, 484](#)

Update Strategy Transformation Overview

The Update Strategy transformation is an active transformation. When you design a data warehouse, you need to decide what type of information to store in targets. As part of the target table design, you need to determine whether to maintain all the historic data or just the most recent changes.

For example, you might have a target table, T_CUSTOMERS, that contains customer data. When a customer address changes, you may want to save the original address in the table instead of updating that portion of the customer row. In this case, you would create a new row containing the updated address, and preserve the original row with the old customer address. This shows how you might store historical information in a target table. However, if you want the T_CUSTOMERS table to be a snapshot of current customer data, you would update the existing customer row and lose the original address.

The model you choose determines how you handle changes to existing rows. In PowerCenter, you set the update strategy at two different levels:

- **Within a session.** When you configure a session, you can instruct the Integration Service to either treat all rows in the same way (for example, treat all rows as inserts), or use instructions coded into the session mapping to flag rows for different database operations.
- **Within a mapping.** Within a mapping, you use the Update Strategy transformation to flag rows for insert, delete, update, or reject.

Note: You can also use the Custom transformation to flag rows for insert, delete, update, or reject.

Setting the Update Strategy

To define an update strategy, complete the following steps:

1. To control how rows are flagged for insert, update, delete, or reject within a mapping, add an Update Strategy transformation to the mapping. Update Strategy transformations are essential if you want to flag rows destined for the same target for different database operations, or if you want to reject rows.

2. Define how to flag rows when you configure a session. You can flag all rows for insert, delete, or update, or you can select the data driven option, where the Integration Service follows instructions coded into Update Strategy transformations within the session mapping.
3. Define insert, update, and delete options for each target when you configure a session. On a target-by-target basis, you can allow or disallow inserts and deletes, and you can choose three different ways to handle updates.

RELATED TOPICS:

- [“Setting the Update Strategy for a Session” on page 483](#)

Flagging Rows Within a Mapping

For the greatest degree of control over the update strategy, you add Update Strategy transformations to a mapping. The most important feature of this transformation is its update strategy expression, used to flag individual rows for insert, delete, update, or reject.

The following table lists the constants for each database operation and their numeric equivalent:

Operation	Constant	Numeric Value
Insert	DD_INSERT	0
Update	DD_UPDATE	1
Delete	DD_DELETE	2
Reject	DD_REJECT	3

The Integration Service treats any other value as an insert.

Forwarding Rejected Rows

You can configure the Update Strategy transformation to either pass rejected rows to the next transformation or drop them. By default, the Integration Service forwards rejected rows to the next transformation. The Integration Service flags the rows for reject and writes them to the session reject file. If you do not select Forward Rejected Rows, the Integration Service drops rejected rows and writes them to the session log file.

If you enable row error handling, the Integration Service writes the rejected rows and the dropped rows to the row error logs. It does not generate a reject file. If you want to write the dropped rows to the session log in addition to the row error logs, you can enable verbose data tracing.

Update Strategy Expressions

Frequently, the update strategy expression uses the IIF or DECODE function from the transformation language to test each row to see if it meets a particular condition. If it does, you can then assign each row a numeric code to flag it for a particular database operation. For example, the following IIF statement flags a row for reject if the entry date is after the apply date. Otherwise, it flags the row for update:

```
IIF( ( ENTRY_DATE > APPLY_DATE), DD_REJECT, DD_UPDATE )
```

To create an Update Strategy transformation:

1. In the Mapping Designer, add an Update Strategy transformation to a mapping.
2. Click Layout > Link Columns.
3. Drag all ports from another transformation representing data you want to pass through the Update Strategy transformation.

In the Update Strategy transformation, the Designer creates a copy of each port you drag. The Designer also connects the new port to the original port. Each port in the Update Strategy transformation is a combination input/output port.

Normally, you would select all of the columns destined for a particular target. After they pass through the Update Strategy transformation, this information is flagged for update, insert, delete, or reject.

4. Open the Update Strategy transformation and rename it.
The naming convention for Update Strategy transformations is `UPD_TransformationName`.
5. Click the Properties tab.
6. Click the button in the Update Strategy Expression field.
The Expression Editor appears.
7. Enter an update strategy expression to flag rows as inserts, deletes, updates, or rejects.
8. Validate the expression and click OK.
9. Click OK.
10. Connect the ports in the Update Strategy transformation to another transformation or a target instance.

Aggregator and Update Strategy Transformations

When you connect Aggregator and Update Strategy transformations as part of the same pipeline, put the Aggregator before the Update Strategy transformation. In this order, the Integration Service performs the aggregate calculation, and then flags rows that contain the results of this calculation for insert, update, delete, or reject.

If you put the Update Strategy before the Aggregator transformation, you must consider how the Aggregator transformation handles rows flagged for different operations. In this order, the Integration Service flags rows for insert, update, delete, or reject before it performs the aggregate calculation. How you flag a row determines how the Aggregator transformation treats values in that row used in the calculation. For example, if you flag a row for delete and then use the row to calculate the sum, the Integration Service subtracts the value in this row. If you flag a row for reject and then use the row to calculate the sum, the Integration Service does not include the value in this row. If you flag a row for insert or update and then use the row to calculate the sum, the Integration Service adds the value in this row to the sum.

Lookup and Update Strategy Transformations

When you create a mapping with a Lookup transformation that uses a dynamic lookup cache, you must use Update Strategy transformations to flag the rows for the target tables. When you configure a session using Update Strategy transformations and a dynamic lookup cache, you must define certain session properties.

You must define the Treat Source Rows As option as Data Driven. Specify this option on the Properties tab in the session properties.

You must also define the following update strategy target table options:

- Select Insert
- Select Update as Update
- Do not select Delete

These update strategy target table options ensure that the Integration Service updates rows marked for update and inserts rows marked for insert.

If you do not choose Data Driven, the Integration Service flags all rows for the database operation you specify in the Treat Source Rows As option and does not use the Update Strategy transformations in the mapping to flag the rows. The Integration Service does not insert and update the correct rows. If you do not choose Update as Update, the Integration Service does not correctly update the rows flagged for update in the target table. As a result, the lookup cache and target table might become unsynchronized.

Setting the Update Strategy for a Session

When you configure a session, you have several options for handling database operations, including updates.

Specifying an Operation for All Rows

When you configure a session, you can select a single database operation for all rows using the Treat Source Rows As setting.

The following table displays the options for the Treat Source Rows As setting:

Setting	Description
Insert	Treat all rows as inserts. If inserting the row violates a primary or foreign key constraint in the database, the Integration Service rejects the row.
Delete	Treat all rows as deletes. For each row, if the Integration Service finds a corresponding row in the target table (based on the primary key value), the Integration Service deletes it. Note that the primary key constraint must exist in the target definition in the repository.
Update	Treat all rows as updates. For each row, the Integration Service looks for a matching primary key value in the target table. If it exists, the Integration Service updates the row. The primary key constraint must exist in the target definition.
Data Driven	Integration Service follows instructions coded into Update Strategy and Custom transformations within the session mapping to determine how to flag rows for insert, delete, update, or reject. If the mapping for the session contains an Update Strategy transformation, this field is marked Data Driven by default. If you do not choose Data Driven when a mapping contains an Update Strategy or Custom transformation, the Workflow Manager displays a warning. When you run the session, the Integration Service does not follow instructions in the Update Strategy or Custom transformation in the mapping to determine how to flag rows.

The following table describes the update strategy for each setting:

Setting	Use To
Insert	Populate the target tables for the first time, or maintain a historical data warehouse. In the latter case, you must set this strategy for the entire data warehouse, not just a select group of target tables.
Delete	Clear target tables.

Setting	Use To
Update	Update target tables. You might choose this setting whether the data warehouse contains historical data or a snapshot. Later, when you configure how to update individual target tables, you can determine whether to insert updated rows as new rows or use the updated information to modify existing rows in the target.
Data Driven	Exert finer control over how you flag rows for insert, delete, update, or reject. Choose this setting if rows destined for the same table need to be flagged on occasion for one operation (for example, update), or for a different operation (for example, reject). In addition, this setting provides the only way you can flag rows for reject.

Specifying Operations for Individual Target Tables

Once you determine how to treat all rows in the session, you also need to set update strategy options for individual targets. Define the update strategy options in the Transformations view on Mapping tab of the session properties.

You can set the following update strategy options:

- **Insert.** Select this option to insert a row into a target table.
- **Delete.** Select this option to delete a row from a table.
- **Update.** You have the following options in this situation:
 - **Update as Update.** Update each row flagged for update if it exists in the target table.
 - **Update as Insert.** Insert each row flagged for update.
 - **Update else Insert.** Update the row if it exists. Otherwise, insert it.
- **Truncate table.** Select this option to truncate the target table before loading data.

Update Strategy Checklist

Choosing an update strategy requires setting the right options within a session and possibly adding Update Strategy transformations to a mapping. This section summarizes what you need to implement different versions of an update strategy.

- Only perform inserts into a target table.
When you configure the session, select Insert for the Treat Source Rows As session property. Also, make sure that you select the Insert option for all target instances in the session.
- Delete all rows in a target table.
When you configure the session, select Delete for the Treat Source Rows As session property. Also, make sure that you select the Delete option for all target instances in the session.
- Only perform updates on the contents of a target table.
When you configure the session, select Update for the Treat Source Rows As session property. When you configure the update options for each target table instance, make sure you select the Update option for each target instance.
- Perform different database operations with different rows destined for the same target table.

Add an Update Strategy transformation to the mapping. When you write the transformation update strategy expression, use either the DECODE or IIF function to flag rows for different operations (insert, delete, update, or reject). When you configure a session that uses this mapping, select Data Driven for the Treat Source Rows As session property. Make sure that you select the Insert, Delete, or one of the Update options for each target table instance.

- Reject data.

Add an Update Strategy transformation to the mapping. When you write the transformation update strategy expression, use DECODE or IIF to specify the criteria for rejecting the row. When you configure a session that uses this mapping, select Data Driven for the Treat Source Rows As session property.

CHAPTER 33

XML Transformations

This chapter includes the following topics:

- [XML Source Qualifier Transformation, 486](#)
- [XML Parser Transformation, 486](#)
- [XML Generator Transformation, 487](#)

XML Source Qualifier Transformation

You can add an XML Source Qualifier transformation to a mapping by dragging an XML source definition to the Mapping Designer workspace or by manually creating one. When you add an XML source definition to a mapping, you need to connect it to an XML Source Qualifier transformation. The XML Source Qualifier transformation defines the data elements that the Integration Service reads when it executes a session. It determines how the PowerCenter reads the source data. The XML Source Qualifier transformation is an active transformation.

An XML Source Qualifier transformation always has one input or output port for every column in the XML source. When you create an XML Source Qualifier transformation for a source definition, the Designer links each port in the XML source definition to a port in the XML Source Qualifier transformation. You cannot remove or edit any of the links. If you remove an XML source definition from a mapping, the Designer also removes the corresponding XML Source Qualifier transformation. You can link one XML source definition to one XML Source Qualifier transformation.

You can link ports of one XML Source Qualifier group to ports of different transformations to form separate data flows. However, you cannot link ports from more than one group in an XML Source Qualifier transformation to ports in the same target transformation.

You can edit some of the properties and add metadata extensions to an XML Source Qualifier transformation.

XML Parser Transformation

Use an XML Parser transformation to extract XML inside a pipeline. The XML Parser transformation lets you extract XML data from messaging systems, such as TIBCO or MQ Series, and from other sources, such as files or databases. The XML Parser transformation functionality is similar to the XML source functionality, except it parses the XML in the pipeline. For example, you might want to extract XML data from a TIBCO source and pass the data to relational targets. The XML Parser transformation is an active transformation.

The XML Parser transformation reads XML data from a single input port and writes data to one or more output ports.

XML Generator Transformation

Use an XML Generator transformation to create XML inside a pipeline. The XML Generator transformation lets you read data from messaging systems, such as TIBCO and MQ Series, or from other sources, such as files or databases. The XML Generator transformation functionality is similar to the XML target functionality, except it generates the XML in the pipeline. For example, you might want to extract data from relational sources and pass XML data to targets. The XML Generator transformation is an active transformation.

The XML Generator transformation accepts data from multiple ports and writes XML through a single output port.

INDEX

A

- ABORT function
 - using [40](#)
 - active transformations
 - Aggregator [49](#)
 - Custom [59](#)
 - Filter [194](#)
 - Java [219](#), [220](#)
 - Joiner [265](#)
 - Normalizer [338](#)
 - overview [24](#)
 - Rank [356](#)
 - Router [361](#)
 - Sorter [378](#)
 - Source Qualifier [383](#), [405](#)
 - Transaction Control [459](#)
 - Union [464](#)
 - Update Strategy [480](#)
 - XML Generator [487](#)
 - XML Parser [486](#)
 - XML Source Qualifier [486](#)
 - Add Statistic Output Port (property)
 - SQL transformation [425](#)
 - adding
 - comments to expressions [33](#)
 - groups [365](#)
 - address.dic
 - masking data [151](#)
 - advanced interface
 - EDataType class [251](#)
 - example [253](#)
 - invoking Java expressions [250](#)
 - Java expressions [250](#)
 - JExpression class [253](#), [254](#)
 - JExprParaMetadata class [251](#)
 - advanced options
 - SQL transformation [414](#)
 - aggregate functions
 - list of [52](#)
 - null values [53](#)
 - overview [52](#)
 - using in expressions [52](#)
 - Aggregator transformation
 - compared to Expression transformation [49](#)
 - components [50](#)
 - creating [57](#)
 - functions list [52](#)
 - group by ports [53](#)
 - nested aggregation [52](#)
 - non-aggregate function example [53](#)
 - null values [53](#)
 - optimizing performance [57](#)
 - overview [49](#)
 - ports [51](#)
 - sorted ports [55](#)
 - Aggregator transformation (*continued*)
 - STDDEV (standard deviation) function [52](#)
 - tracing levels [50](#)
 - troubleshooting [58](#)
 - Update Strategy combination [482](#)
 - using variables [35](#)
 - using with the Joiner transformation [272](#)
 - VARIANCE function [52](#)
 - Aggregator transformations
 - conditional clause example [53](#)
 - All Input transformation scope
 - behavior in Joiner transformation [275](#)
 - API functions
 - Custom transformation [92](#)
 - API methods
 - Java transformation [235](#)
 - Java transformations [235](#)
 - array-based functions
 - data handling [119](#)
 - is row valid [118](#)
 - maximum number of rows [116](#)
 - number of rows [117](#)
 - overview [116](#)
 - row strategy [121](#)
 - set input error row [122](#)
 - ASCII
 - Custom transformation [60](#)
 - External Procedure transformation [161](#)
 - ASCII mode
 - configuring sort order for Joiner transformation [270](#)
 - associated ports
 - Lookup transformation [322](#)
 - sequence ID [322](#)
 - auto-commit
 - configuring with SQL transformation [417](#)
 - description [425](#)
 - AutoCommit
 - SQL Settings tab [425](#)
- ## B
- BankSoft example
 - Informatica external procedure [171](#)
 - overview [162](#)
 - Base URL
 - configuring [205](#)
 - BigDecimal datatype
 - Java transformation [232](#)
 - blocking
 - detail rows in Joiner transformation [275](#)
 - blocking data
 - Custom transformation [68](#)
 - Custom transformation functions [111](#)
 - Joiner transformation [275](#)

blocking transformations
description [30](#)
blurring
date values [140](#)
numeric values [140](#)

C

C/C++
linking to Integration Service [182](#)
cache directories
configuring lookup cache directory name [288](#)
cache directory
Data Masking transformation [149](#)
Cache Directory (property)
Joiner transformation [266](#)
cache file name
specifying for persistent lookup cache [288](#)
cache file name prefix
overview [313](#)
Cache File Name Prefix (property)
description [288](#)
cache size
Data Masking transformation [149](#)
caches
concurrent [309, 310](#)
dynamic lookup cache [320](#)
Joiner transformation [275](#)
Lookup transformation [307](#)
named persistent lookup [313](#)
sequential [309](#)
sharing lookup [313](#)
static lookup cache [312](#)
caching
master rows in Joiner transformation [275](#)
calculations
aggregate [49](#)
using the Expression transformation [157](#)
using variables with [36](#)
call text
stored procedure, entering [453](#)
Call Text (property)
Stored Procedure transformation [448](#)
Case Sensitive (property)
Sorter transformation [380](#)
Class Name (property)
Java transformation [224](#)
CLASSPATH
Java transformation, configuring [230](#)
COBOL
VSAM Normalizer transformation [342](#)
COBOL source definitions
creating a Normalizer transformation [346](#)
OCCURS statement [342](#)
code page ID
Custom transformation, changing [113](#)
code pages
access functions [191](#)
Custom transformation [60](#)
External Procedure transformation [161](#)
code snippets
creating for Java transformations [227](#)
COM external procedures
adding to repository [168](#)
compared to Informatica external procedures [162](#)
creating [164](#)
creating a source [168](#)

COM external procedures (*continued*)
creating a target [168](#)
datatypes [180](#)
debugging [182](#)
developing in Visual Basic [170](#)
developing in Visual C++ [165, 168](#)
development notes [180](#)
distributing [179](#)
exception handling [182](#)
initializing [185](#)
memory management [182](#)
overview [164](#)
registering with repositories [168](#)
return values [181](#)
row-level procedures [181](#)
server type [164](#)
unconnected [184](#)
COM servers
type for COM external procedures [164](#)
comments
adding to expressions [33](#)
commit
Java transformation API method [236](#)
company_names.dic
masking data [151](#)
compilation errors
identifying the source of in Java transformations [233](#)
compiling
Custom transformation procedures [79](#)
DLLs on Windows systems [177](#)
Java transformations [232](#)
composite keys
creating with Sequence Generator transformation [370](#)
concurrent caches
See caches [309](#)
conditions
Filter transformation [195](#)
Joiner transformation [267](#)
Lookup transformation [297, 301](#)
Router transformation [363](#)
configuring
ports [29](#)
connect string
syntax [414](#)
connected lookups
creating [303](#)
description [284](#)
overview [285](#)
connected transformations
Aggregator [49](#)
Custom [59](#)
Expression [157](#)
Filter [194](#)
Java [219](#)
Joiner [265](#)
Lookup [280](#)
Normalizer [338](#)
Rank [356](#)
Router [361](#)
Sequence Generator [367](#)
Source Qualifier [383](#)
SQL [405](#)
Stored Procedure [439](#)
Union transformation [464](#)
Update Strategy [480](#)
XML Generator [487](#)
XML Parser [486](#)
XML Source Qualifier [486](#)

- connecting to databases
 - SQL transformation [412](#)
- Connection Information (property)
 - Lookup transformation [288](#)
 - Stored Procedure transformation [448](#)
- connection objects
 - configuring in Lookup transformations [288](#)
 - configuring in Stored Procedure transformations [448](#)
- connection settings
 - SQL transformation [413](#)
- connection variables
 - using in Lookup transformations [288](#)
 - using in Stored Procedure transformations [448](#)
- connections
 - SQL transformation [412](#)
- connectivity
 - connect string examples [414](#)
- constants
 - replacing null values with [40](#)
- Continue on SQL Error Within Row (property)
 - SQL transformation [425](#)
- creating
 - Aggregator transformation [57](#)
 - COM external procedures [164](#)
 - Custom transformation [61](#), [71](#)
 - Expression transformation [159](#)
 - Filter transformation [196](#)
 - Informatica external procedures [171](#)
 - Joiner transformation [277](#)
 - non-reusable instance of reusable transformation [47](#)
 - ports [29](#)
 - Rank transformation [359](#)
 - reusable transformations [46](#)
 - Router transformation [366](#)
 - Sequence Generator transformation [376](#)
 - Stored Procedure transformation [445](#)
 - transformations [28](#)
 - Union transformation [465](#)
 - Update Strategy transformation [481](#)
- current value
 - Sequence Generator transformation [374](#)
- Current Value (property)
 - Sequence Generator transformation [371](#)
- CURRVAL port
 - Sequence Generator transformation [370](#)
- custom functions
 - using with Java expressions [246](#)
- Custom transformation
 - blocking data [68](#)
 - building the module [79](#)
 - code pages [60](#)
 - compiling procedures [79](#)
 - components [62](#)
 - creating [61](#), [71](#)
 - creating groups [62](#)
 - creating ports [62](#)
 - creating procedures [70](#)
 - defining port relationships [63](#)
 - distributing [61](#)
 - functions [82](#)
 - Generate Transaction property [67](#)
 - generating code files [61](#), [73](#)
 - initialization properties [70](#)
 - Inputs May Block property [68](#)
 - Is Partitionable (property) [64](#)
 - metadata extensions [70](#)
 - overview [59](#)
 - passing rows to procedure [86](#)

- Custom transformation (*continued*)
 - port attributes [64](#)
 - procedure properties [70](#)
 - properties [64](#)
 - property IDs [97](#)
 - Requires Single Thread property [64](#)
 - rules and guidelines [61](#)
 - setting the update strategy [66](#)
 - thread-specific code [64](#)
 - threads [66](#)
 - transaction boundary [68](#)
 - transaction control [67](#)
 - Transformation Scope property [67](#)
 - Update Strategy property [66](#)
- Custom transformation functions
 - API [92](#)
 - array-based [116](#)
 - blocking logic [111](#)
 - change default row strategy [115](#)
 - change string mode [113](#)
 - data boundary output [109](#)
 - data handling (array-based) [119](#)
 - data handling (row-based) [105](#)
 - deinitialization [91](#)
 - error [109](#)
 - generated [87](#)
 - increment error count [110](#)
 - initialization [88](#)
 - is row valid [118](#)
 - is terminated [111](#)
 - maximum number of rows [116](#)
 - navigation [94](#)
 - notification [89](#)
 - number of rows [117](#)
 - output notification [108](#)
 - pointer [112](#)
 - property [96](#)
 - rebind datatype [103](#)
 - row strategy (array-based) [121](#)
 - row strategy (row-based) [114](#)
 - session log [109](#)
 - set data access mode [93](#)
 - set data code page [113](#)
 - set input error row [122](#)
 - set pass-through port [107](#)
 - working with handles [82](#), [94](#)
- Custom transformation procedures
 - creating [70](#)
 - example [74](#)
 - generating code files [73](#)
 - thread-specific [64](#)
 - working with rows [86](#)
- cycle
 - Sequence Generator transformation property [373](#)
- Cycle (property)
 - Sequence Generator transformation property [371](#)

D

- data
 - joining [265](#)
 - pre-sorting [56](#)
 - rejecting through Update Strategy transformation [484](#)
 - selecting distinct [401](#)
 - storing temporary [36](#)
- data access mode function
 - Custom transformation function [93](#)

- data driven
 - overview [483](#)
- data handling functions
 - array-based [119](#)
 - row-based [105](#)
- data masking
 - mapping with Expression transformation [154](#)
 - mapping with Lookup transformation [151](#)
- data masking transformation
 - masking IP addresses [148](#)
- Data Masking transformation
 - blurring [140](#)
 - cache directory [149](#)
 - cache size [149](#)
 - configuring relational dictionaries [133](#)
 - connection requirements [133](#)
 - Data Masking transformation [149](#)
 - default value file [149](#)
 - dependent data masking [134](#)
 - dictionary for substitution masking [130](#)
 - dictionary name expression masking [141](#)
 - expression masking [141](#)
 - expression masking guidelines [142](#)
 - mask format [137](#)
 - masking date values [140](#)
 - masking email addresses [146](#)
 - masking phone numbers [145](#)
 - masking properties [126](#)
 - masking Social Insurance numbers [147](#)
 - masking social security numbers [144](#)
 - masking URLs [148](#)
 - random masking [135](#)
 - range [139](#)
 - repeatable dependent masking [135](#)
 - repeatable expression masking [141](#)
 - repeatable SIN numbers [148](#)
 - repeatable SSN [145](#)
 - rules and guidelines [150](#)
 - session properties [149](#)
 - shared storage table [149](#)
 - source string characters [138](#)
 - storage commit interval [149](#)
 - storage table [141](#)
 - storage tables [131](#)
 - substitution masking [130](#)
 - substitution masking properties [131](#), [132](#)
 - unique output [149](#)
 - using mapping parameters [127](#)
- Data Transformation
 - overview [467](#)
 - repository location [469](#)
- data types
 - Java transformations [220](#)
- database connections
 - SQL transformation [412](#)
- database resilience
 - SQL transformation [417](#)
- databases
 - joining data from different [265](#)
- datatypes
 - COM [180](#)
 - Source Qualifier [384](#)
 - transformation [180](#)
- date values
 - random data masking [136](#)
- datetime values
 - data masking [130](#)
 - Source Qualifier transformation [384](#)
- DB2
 - See IBM DB2 [414](#)
- debugging
 - external procedures [182](#)
 - Java transformation [233](#)
- default groups
 - Router transformation [363](#)
- default join
 - Source Qualifier [388](#)
- default query
 - methods for overriding [387](#)
 - overriding using Source Qualifier [390](#)
 - overview [386](#)
 - viewing [386](#)
- default values
 - Aggregator group by ports [55](#)
 - data masking [149](#)
 - entering [44](#)
 - input ports [38](#), [39](#)
 - output ports [38](#), [39](#)
 - overview [38](#)
 - pass-through ports [38](#), [39](#)
 - rules for [44](#)
 - user-defined [39](#)
 - validating [44](#)
- defineJExpression
 - Java expression API method [252](#)
- defining
 - port dependencies in Custom transformation [63](#)
- deinitialization functions
 - Custom transformation [91](#)
- dependencies
 - ports in Custom transformations [63](#)
- dependent column
 - data masking [134](#)
- dependent masking
 - description [134](#)
 - repeatable masking [135](#)
- detail outer join
 - description [270](#)
- detail rows
 - blocking in Joiner transformation [275](#)
 - processing in sorted Joiner transformation [275](#)
 - processing in unsorted Joiner transformation [275](#)
- developing
 - COM external procedures [164](#)
 - Informatica external procedures [171](#)
- dictionary
 - repeatable expression masking [141](#)
 - substitution data masking [130](#)
- dictionary information
 - Data Masking transformation [132](#)
- dispatch function
 - description [188](#)
- distinct output rows
 - Sorter transformation [380](#)
- distributing
 - Custom transformation procedures [61](#)
 - external procedures [179](#)
- DLLs (dynamic linked libraries)
 - compiling external procedures [177](#)
- double datatypes
 - Java transformation [232](#)
- dynamic connections
 - performance considerations [415](#)
 - SQL transformation [413](#)
 - SQL transformation example [434](#)

- dynamic lookup cache
 - description [320](#)
 - error threshold [331](#)
 - lookup SQL override [325](#)
 - reject loading [331](#)
 - synchronizing with target [331](#)
 - using flat file sources [320](#)
- Dynamic Lookup Cache (property)
 - description [288](#)
- Dynamic Service Name
 - Unstructured Data transformation [471](#)
- dynamic SQL queries
 - SQL transformation [409](#)
 - SQL transformation example [429](#)

E

- EDataType class
 - Java expressions [251](#)
- effective Transaction Control transformation
 - definition [461](#)
- Enable XML Input Streaming
 - XML Parser session property [477](#)
- encrypt storage
 - Data Masking transformation [149](#)
- End Value (property)
 - Sequence Generator transformation [371](#)
- entering
 - expressions [31](#), [32](#)
 - source filters [399](#)
 - SQL query override [390](#)
 - user-defined joins [391](#)
- environment variables
 - setting for Java packages [230](#)
- error counts
 - incrementing for Java transformations [239](#)
- ERROR function
 - using [40](#)
- error handling
 - for stored procedures [454](#)
 - with dynamic lookup cache [331](#)
- error messages
 - for external procedures [182](#)
 - tracing for external procedures [182](#)
- error rows
 - SQL transformation [421](#)
- errors
 - handling [42](#)
 - increasing threshold in Java transformations [239](#)
 - validating in Expression Editor [33](#)
 - with dynamic lookup cache [331](#)
- exactly-once delivery
 - SQL transformation [417](#)
- exceptions
 - from external procedures [182](#)
- Execution Order (property)
 - Stored Procedure transformation [448](#)
- export to XML schema
 - Unstructured Data transformation [475](#)
- Expression Editor
 - overview [32](#)
 - syntax colors [33](#)
 - using with Java expressions [247](#)
 - validating expressions using [33](#)
- expression masking
 - description [141](#)
 - repeatable masking [141](#)

- expression masking (*continued*)
 - repeatable masking example [142](#)
 - rules and guidelines [142](#)
- Expression transformation
 - creating [159](#)
 - overview [157](#)
 - routing data [159](#)
 - using variables [35](#)
- expressions
 - Aggregator transformation [52](#)
 - calling lookups [302](#)
 - calling stored procedure from [450](#)
 - entering [31](#), [32](#)
 - Filter condition [195](#)
 - Java transformations [245](#)
 - non-aggregate [55](#)
 - return values [31](#)
 - rules for Stored Procedure transformation [456](#)
 - simplifying [36](#)
 - update strategy [481](#)
 - validating [33](#)
- External Procedure transformation
 - 64-bit[External Procedure transformation
sixty four] [189](#)
 - ATL objects [165](#)
 - BankSoft example [162](#)
 - building libraries for C++ external procedures [167](#)
 - building libraries for Informatica external procedures [177](#)
 - building libraries for Visual Basic external procedures [171](#)
 - code page access function [191](#)
 - COM datatypes [180](#)
 - COM external procedures [164](#)
 - COM vs. Informatica types [162](#)
 - creating in Designer [172](#)
 - debugging [182](#)
 - description [161](#)
 - development notes [180](#)
 - dispatch function [188](#)
 - exception handling [182](#)
 - external procedure function [188](#)
 - files needed [186](#)
 - IDispatch interface [164](#)
 - Informatica external procedure using BankSoft example [171](#)
 - Informatica external procedures [171](#)
 - initializing [185](#)
 - interface functions [187](#)
 - Is Partitionable (property) [162](#)
 - member variables [189](#)
 - memory management [182](#)
 - MFC AppWizard [177](#)
 - Module (property) [162](#)
 - multi-threaded code [160](#)
 - Output is Deterministic (property) [162](#)
 - Output is Repeatable (property) [162](#)
 - overview [160](#)
 - parameter access functions [189](#)
 - partition related functions [192](#)
 - process variable support [187](#)
 - Programmatic Identifier (property) [162](#)
 - properties [161](#), [162](#)
 - property access function [188](#)
 - return values [181](#)
 - row-level procedure [181](#)
 - Runtime Location (property) [162](#)
 - session [169](#)
 - Tracing Level (property) [162](#)
 - tracing level function [192](#)
 - unconnected [184](#)

- External Procedure transformation (*continued*)
 - using in a mapping [168](#)
 - Visual Basic [170](#)
 - Visual C++ [165](#)
 - wrapper classes [182](#)
- external procedures
 - debugging [182](#)
 - development notes [180](#)
 - distributing [179](#)
 - distributing Informatica external procedures [180](#)
 - interface functions [187](#)

F

- failing sessions
 - Java transformations [237](#)
- failSession method
 - Java transformations [237](#)
- file input type
 - Unstructured Data transformation [473](#)
- file output type
 - Unstructured Data transformation [477](#)
- Filter transformation
 - condition [195](#)
 - creating [196](#)
 - example [194](#)
 - overview [194](#)
 - performance tips [196](#)
 - tips for developing [196](#)
- filtering rows
 - Source Qualifier as filter [196](#)
 - transformation for [194](#), [378](#)
- filtering source rows
 - Lookup transformation [297](#)
- firstnames.dic
 - masking data [151](#)
- flat file lookups
 - description [281](#)
 - sorted input [282](#)
- flat files
 - joining data [265](#)
 - lookups [281](#)
- foreign keys
 - creating with Sequence Generator transformation [370](#)
- Forwarding Rejected Rows
 - configuring [481](#)
 - option [481](#)
- full code window
 - Java compilation errors [233](#)
- full database connection
 - passing to SQL transformation [413](#)
- full outer join
 - definition [270](#)
- functions
 - aggregate [52](#)
 - Custom transformation API [92](#)
 - non-aggregate [53](#)

G

- generate Java code
 - Java expressions [247](#)
- generate output row
 - Java transformations [237](#)
- generate rollback row
 - Java transformation [241](#)

- generate transaction
 - Java transformation [225](#)
- Generate Transaction (property)
 - Java transformation [224](#)
- generated column ID
 - Normalizer transformation [339](#)
- generated functions
 - Custom transformation [87](#)
- generated keys
 - Normalizer transformation [342](#)
- generateRow method
 - Java transformations [237](#)
- generating transactions
 - Custom transformation [67](#)
 - Java transformation [226](#), [236](#)
- getBytes method
 - Java transformations [254](#)
- getDouble method
 - Java transformations [255](#)
- getInRowType method
 - Java transformations [238](#)
- getInt method
 - Java transformations [255](#)
- getLong method
 - Java transformations [255](#)
- getMetada method
 - Java transformations [238](#)
- getResultDataType method
 - Java transformations [255](#)
- getResultMetadata method
 - Java transformations [255](#)
- getStringBuffer method
 - Java transformations [256](#)
- group by ports
 - Aggregator transformation [53](#)
 - non-aggregate expression [55](#)
 - using default values [55](#)
- group filter condition
 - Router transformation [363](#)
- groups
 - adding [365](#)
 - Custom transformation [62](#)
 - Custom transformation rules [63](#)
 - HTTP transformation [201](#)
 - Java transformation [222](#)
 - Router transformation [363](#)
 - Union transformation [465](#)
 - user-defined [363](#)

H

- handles
 - Custom transformation [82](#)
- Helper Code tab
 - example [261](#)
 - Java transformations [227](#)
- high precision
 - enabling for Java transformation [232](#)
- HTTP transformation
 - authentication [199](#)
 - Base URL [205](#)
 - configuring groups and ports [201](#)
 - configuring HTTP tab [201](#)
 - configuring properties [201](#)
 - creating [199](#)
 - examples [207](#)
 - groups [201](#)

HTTP transformation (*continued*)
Is Partitionable (property) [200](#)
Requires Single Thread per Partition property [200](#)
response codes [198](#)
thread-specific code [200](#)

I

IBM DB2
connect string syntax [414](#)
IDispatch interface
defining a class [164](#)
IDM_Dictionary
data masking connection [133](#)
IDM_Storage
data masking connection [133](#)
Ignore in Comparison (property)
description [324](#)
Ignore Null (property)
selecting [323](#)
IIF function
replacing missing keys with Sequence Generator transformation [370](#)
Import Packages tab
example [260](#)
Java transformations [227](#)
Increment By (property)
Sequence Generator transformation property [371](#)
incrementErrorCount method
Java transformations [239](#)
incrementing
setting sequence interval [373](#)
indexes
lookup conditions [305](#)
lookup table [286](#), [305](#)
ineffective Transaction Control transformation
definition [461](#)
Informatica external procedures
compared to COM [162](#)
debugging [182](#)
developing [171](#)
development notes [180](#)
distributing [180](#)
exception handling [182](#)
generating C++ code [174](#)
initializing [185](#)
memory management [182](#)
return values [181](#)
row-level procedures [181](#)
unconnected [184](#)
Informix
stored procedure notes [444](#)
initialization functions
Custom transformation [88](#)
initializing
Custom transformation procedures [70](#)
external procedures [185](#)
Integration Service variable support for [187](#)
variables [38](#)
Input Hierarchy tab
Unstructured Data transformation [475](#)
input parameters
stored procedures [440](#)
input ports
default values [38](#)
Java transformations [223](#)
overview [30](#)

input ports (*continued*)
using as variables [228](#)
input rows
getting the row type for [238](#)
input/output ports
overview [30](#)
InputBuffer port
Unstructured Data transformation [472](#)
Inputs Must Block (property)
Java transformation [224](#)
InputType
Unstructured Data transformation [471](#)
Insert Else Update (property)
description [328](#)
instance variable
Java transformation [228](#), [229](#)
instance variables
Java transformations [227](#)
instances
creating reusable transformations [46](#)
Integration Service
aggregating data [53](#)
datatypes [180](#)
error handling of stored procedures [454](#)
running in debug mode [182](#)
transaction boundary [68](#)
variable support [187](#)
invoke
Java expression API method [256](#)
invokeJExpression
API method [248](#)
Is Active (property)
Java transformation [224](#)
Is Partitionable (property)
Custom transformation [64](#)
External Procedure transformation [162](#)
HTTP transformation [200](#)
Java transformation [224](#)
isNull method
Java transformations [240](#)
isResultNull method
Java transformations [256](#)

J

Java Classpath
session property [231](#)
Java code snippets
creating for Java transformations [227](#)
example [260](#)
Java Code tab
using [221](#)
Java expression API method
getResultDataType [255](#)
Java expression API methods
defineJExpression [252](#)
getBytes [254](#)
getDouble [255](#)
getInt [255](#)
getLong [255](#)
getResultMetadata [255](#)
getStringBuffer [256](#)
invoke [256](#)
isResultNull [256](#)
Java expressions
advanced interface [250](#)
advanced interface example [253](#)

Java expressions (*continued*)

- configuring [246](#)
- configuring functions [247](#)
- creating [247](#)
- creating in the Define Expression dialog box [247](#)
- EDataType class [251](#)
- expression function types [246](#)
- generate Java code [247](#)
- generating [246](#)
- invokeJExpression API method [248](#)
- invoking with advanced interface [250](#)
- invoking with simple interface [248](#)
- Java transformations [245](#)
- JExpression class [253](#), [254](#)
- JExprParaMetadata class [251](#)
- rules and guidelines [248](#), [250](#)
- simple interface [248](#)
- simple interface example [249](#)
- using custom functions [246](#)
- using transformation language functions [246](#)
- using user-defined functions [246](#)

Java packages

- importing [227](#)

Java primitive data types

- Java transformations [220](#)

Java transformation

- API methods [235](#)
- Class Name (property) [224](#)
- compilation errors [233](#)
- creating groups [222](#)
- creating Java code [226](#)
- creating ports [222](#)
- debugging [233](#)
- example [258](#)
- Generate Transaction (property) [226](#)
- Generate Transaction property [224](#)
- Inputs Must Block (property) [224](#)
- Is Partitionable (property) [224](#)
- Java Code tab [221](#)
- Language (property) [224](#)
- locating errors [233](#)
- On End of Data tab [229](#)
- On Input Row tab [228](#)
- On Receiving Transaction tab [229](#)
- Output is Deterministic property [224](#)
- Output is Ordered property [224](#)
- overview [219](#)
- parsing a flat file [229](#)
- processing subseconds [232](#)
- properties [224](#)
- Requires Single Thread Per Partition property [224](#)
- session-level classpath [231](#)
- setting CLASSPATH [230](#)
- setting output row type [242](#)
- setting the update strategy [226](#)
- Tracing Level (property) [224](#)
- transaction control [225](#)
- transformation level classpath [230](#)
- Transformation Scope (property) [224](#), [225](#)
- Update Strategy (property) [226](#)

Java transformation API methods

- commit [236](#)
- rollback [241](#)
- setOutRowType [242](#)

Java transformations

- active [220](#)
- API methods [235](#)
- checking null values in [240](#)

Java transformations (*continued*)

- compiling [232](#)
- creating groups [222](#)
- creating Java code snippets [227](#)
- creating ports [222](#)
- data type conversion [220](#)
- default port values [223](#)
- failing sessions in [237](#)
- failSession method [237](#)
- generateRow method [237](#)
- getInRowType method [238](#)
- getMetadata method [238](#)
- getting the input row type [238](#)
- Helper Code tab [227](#)
- identifying the source of compilation errors [233](#)
- Import Package tab [227](#)
- incrementErrorCount method [239](#)
- input ports [223](#)
- isNull method [240](#)
- Java primitive data types [220](#)
- logError method [240](#)
- logInfo method [241](#)
- logs [240](#)
- non-user code errors [234](#)
- output ports [223](#)
- passive [220](#)
- retrieving metadata [238](#)
- session logs [241](#)
- setNull method [242](#)
- setting null values in [242](#)
- storeMetadata method [243](#)
- storing metadata [243](#)
- user code errors [234](#)

JDK

- Java transformation [219](#)

JExpression class

- Java expressions [253](#), [254](#)

JExprParaMetadata class

- Java expressions [251](#)

join condition

- defining [272](#)
- overview [267](#)
- using sort origin ports [270](#)

join override

- left outer join syntax [394](#)
- normal join syntax [393](#)
- right outer join syntax [396](#)

join syntax

- left outer join [394](#)
- normal join [393](#)
- right outer join [396](#)

join type

- detail outer join [270](#)
- full outer join [270](#)
- Joiner properties [268](#)
- left outer join [392](#)
- master outer join [269](#)
- normal join [268](#)
- right outer join [392](#)
- Source Qualifier transformation [392](#)

Join Type (property)

- Joiner transformation [266](#)

joiner cache

- Joiner transformation [275](#)

Joiner data cache size

- Joiner transformation property [266](#)

Joiner index cache size

- Joiner transformation property [266](#)

Joiner transformation

- All Input transformation scope [275](#)
- behavior with All Input transformation scope [275](#)
- behavior with Row transformation scope [275](#)
- behavior with Transaction transformation scope [275](#)
- blocking source data [275](#)
- caches [275](#)
- conditions [267](#)
- configuring join condition to use sort origin ports [270](#)
- configuring sort order [271](#)
- configuring sort order in ASCII mode [270](#)
- configuring sort order in Unicode mode [270](#)
- creating [277](#)
- dropping transaction boundaries [277](#)
- join types [268](#)
- joining data from the same source [273](#)
- joining multiple databases [265](#)
- overview [265](#)
- performance tips [278](#)
- preserving transaction boundaries [276](#)
- processing real-time data [277](#)
- properties [266](#)
- real-time data [275](#)
- Row transformation scope [275](#)
- rules for input [265](#)
- Transaction transformation scope [275](#)
- transactions [275](#)
- transformation scope [275](#)
- using with Sorter transformation [271](#)

joining sorted data

- configuring to optimize join performance [271](#)
- using sorted flat files [271](#)
- using sorted relational data [271](#)
- using Sorter transformation [271](#)

joins

- creating key relationships for [389](#)
- custom [389](#)
- default for Source Qualifier [388](#)
- Informatica syntax [392](#)
- user-defined [391](#)

JRE

- Java transformation [219](#)

K

key masking

- description [128](#)
- masking datetime values [130](#)
- masking numeric values [129](#)
- masking string values [128](#)
- numeric values [128](#)

key type attribute

- Normalizer transformation [345](#)

keys

- creating for joins [389](#)
- creating with Sequence Generator transformation [370](#)
- source definitions [389](#)

L

Language (property)

- Java transformation [224](#)

left outer join

- creating [394](#)
- syntax [394](#)

Level attribute

- pipeline Normalizer transformation [349](#)
- VSAM Normalizer transformation [345](#)

libraries

- for C++ external procedures [167](#)
- for Informatica external procedures [177](#)
- for VB external procedures [171](#)

load order

- Source Qualifier [384](#)

load types

- stored procedures [453](#)

local variables

- overview [35](#)

logError method

- Java transformations [240](#)

logical database connection

- passing to SQL transformation [413](#)
- performance considerations [415](#)

LogicalConnectionObject

- description [413](#)
- SQL transformation example [437](#)

logInfo method

- Java transformations [241](#)

logs

- Java transformations [240](#)

Lookup Cache Directory Name (property)

- description [288](#)

Lookup Cache Persistent (property)

- description [288](#)

lookup caches

- definition [307](#)
- dynamic [320](#)
- dynamic, error threshold [331](#)
- dynamic, synchronizing with lookup source [335](#)
- dynamic, synchronizing with target [331](#)
- enabling caching [288](#)
- handling first and last values [299](#)
- Lookup Cache Persistent property [288](#)
- Lookup Data Cache Size property [288](#)
- named persistent caches [313](#)
- overriding ORDER BY [294](#)
- overview [307](#)
- partitioning guidelines with unnamed caches [313](#)
- persistent [311](#)
- pre-building cache [288](#)
- recache from database [309](#)
- reject loading [331](#)
- sharing [313](#)
- sharing unnamed lookups [313](#)
- static [312](#)

Lookup Caching Enabled (property)

- description [288](#)

lookup condition

- configure [297](#)
- Data Masking transformation [132](#)
- definition [287](#)
- overview [298](#)

Lookup Policy on Multiple Match (property)

- description [288](#)

lookup ports

- description [286](#)

lookup properties

- configuring in a session [292](#)

lookup query

- default query [294](#)
- description [294](#)
- ORDER BY [294](#)
- overriding [294](#)

- lookup query (*continued*)
 - reserved words [295](#)
 - Sybase ORDER BY limitation [294](#)
- lookup source filter
 - description [288](#)
 - limiting lookups [297](#)
- lookup SQL override
 - dynamic caches [325](#)
- Lookup SQL Override option
 - description [288](#)
 - mapping parameters and variables [294](#)
 - reducing cache size [294](#)
- lookup table
 - indexes [286](#), [305](#)
 - name [288](#)
- Lookup transformation
 - associated input port [322](#)
 - cache sharing [313](#)
 - caches [307](#)
 - components of [286](#)
 - condition [297](#), [301](#)
 - configuring pipeline lookup session properties [293](#)
 - connected [284](#), [285](#)
 - creating connected lookup [303](#)
 - default query [294](#)
 - dynamic cache [320](#)
 - entering custom queries [296](#)
 - error threshold [331](#)
 - expressions [302](#)
 - flat file lookups [280](#), [281](#)
 - ignore in comparison [324](#)
 - ignore null [323](#)
 - input port [286](#)
 - lookup port [286](#)
 - lookup sources [280](#)
 - mapping parameters and variables [294](#)
 - multiple matches [299](#)
 - named persistent cache [313](#)
 - non-reusable pipeline [305](#)
 - output port [286](#)
 - overriding the default query [294](#)
 - overview [280](#)
 - performance tips [305](#)
 - persistent cache [311](#)
 - pipeline lookup description [280](#)
 - pipeline lookup example [283](#)
 - ports [286](#)
 - properties [288](#)
 - recache from database [309](#)
 - reject loading [331](#)
 - return values [302](#)
 - returning multiple rows [300](#)
 - reusable pipeline [304](#)
 - sequence ID [322](#)
 - subsecond precision for datetime ports [288](#)
 - synchronizing dynamic cache with a lookup source [335](#)
 - synchronizing dynamic cache with lookup source [335](#)
 - synchronizing dynamic cache with target [331](#)
 - unconnected [284](#), [285](#), [301](#)
 - Update Strategy combination [482](#)
 - using pipeline in mapping [283](#)

M

- mapper
 - Data Transformation [469](#)

- Mapping Designer
 - adding reusable transformation [47](#)
- mapping parameters
 - in lookup SQL override [294](#)
 - in Source Qualifier transformations [385](#)
- mapping variables
 - in lookup SQL override [294](#)
 - in Source Qualifier transformations [385](#)
 - reusable transformations [46](#)
- mappings
 - adding a COBOL source [342](#)
 - adding reusable transformations [47](#)
 - adding transformations [28](#)
 - affected by stored procedures [441](#)
 - configuring connected Stored Procedure transformation [449](#)
 - configuring unconnected Stored Procedure transformation [450](#)
 - flagging rows for update [481](#)
 - lookup components [286](#)
 - modifying reusable transformations [48](#)
 - using an External Procedure transformation [168](#)
 - using Router transformations [366](#)
- mask format
 - masking string values [137](#)
- masking data
 - sample addresses [151](#)
 - sample company names [151](#)
 - sample first names [151](#)
 - sample last names [151](#)
 - sample lookup data [151](#)
- masking parameters
 - data masking [127](#)
- Masking Properties tab
 - Data Masking transformation [126](#)
- masking rules
 - applying [137](#)
 - blurring [140](#)
 - mask format [137](#)
 - range [139](#)
 - result string replacement characters [139](#)
 - source string characters [138](#)
- masking techniques
 - encryption [143](#)
 - format preserving encryption [143](#)
- master outer join
 - description [269](#)
 - preserving transaction boundaries [276](#)
- master rows
 - caching [275](#)
 - processing in sorted Joiner transformation [275](#)
 - processing in unsorted Joiner transformation [275](#)
- Master Sort Order (property)
 - Joiner transformation [266](#)
- Max Output Row Count (property)
 - SQL transformation [425](#)
- Maximum Number of Connections in Pool (property)
 - SQL transformation [425](#)
- memory management
 - for external procedures [182](#)
- metadata extensions
 - in Custom transformations [70](#)
- methods
 - Java transformation [228](#), [229](#)
 - Java transformation API [235](#)
- MFC AppWizard
 - overview [177](#)
- Microsoft SQL Server
 - connect string syntax [414](#)
 - stored procedure notes [445](#)

- missing values
 - replacing with Sequence Generator [370](#)
- Module (property)
 - External Procedure transformation [162](#)
- multi-group
 - transformations [30](#)
- multiple matches
 - lookup policy property [288](#)
 - Lookup transformation [299](#)

N

- named cache
 - persistent [311](#)
 - recache from database [311](#)
 - sharing [315](#)
- named persistent lookup cache
 - overview [313](#)
 - sharing [315](#)
- NaN
 - converting to 1.#QNAN [403](#)
- native datatypes
 - SQL transformation [408](#)
- native transformations
 - overview [25](#)
- NEXTVAL port
 - Sequence Generator [368](#)
- non-aggregate expressions
 - overview [55](#)
- non-aggregate functions
 - example [53](#)
- non-native transformations
 - overview [25](#)
- non-user code errors
 - in Java transformations [234](#)
- normal join
 - creating [393](#)
 - definition [268](#)
 - preserving transaction boundaries [276](#)
 - syntax [393](#)
- Normal tracing levels
 - overview [44](#)
- Normalizer transformation
 - creating a pipeline Normalizer transformation [350](#)
 - creating a VSAM Normalizer transformation [346](#)
 - example [351](#)
 - generated column ID [339](#)
 - generated key [342](#)
 - Key Type attribute [345](#)
 - Level attribute [345](#), [349](#)
 - mapping example [351](#)
 - Normalizer tab [340](#)
 - Occurs attribute [340](#)
 - overview [338](#)
 - pipeline Normalizer [347](#)
 - pipeline Normalizer Ports tab [348](#)
 - Ports tab [339](#)
 - Properties tab [340](#)
 - troubleshooting [354](#)
 - VSAM Normalizer [342](#)
- notification functions
 - Custom transformation [89](#)
- Null Ordering in Detail (property)
 - Joiner transformation [266](#)
- Null Ordering in Master (property)
 - Joiner transformation [266](#)

- null values
 - aggregate functions [53](#)
 - checking in Java transformations [240](#)
 - filtering [196](#)
 - replacing using aggregate functions [55](#)
 - replacing with a constant [40](#)
 - setting for Java transformation [242](#)
 - skipping [41](#)
 - Sorter transformation [381](#)
- number of cached values
 - Sequence Generator property value [371](#)
 - Sequence Generator transformation property [374](#)
- numeric values
 - key masking [129](#)
 - random masking [136](#)
- NumRowsAffected port
 - SQL transformation [420](#)

O

- Occurs attribute
 - Normalizer transformation [340](#)
- OCCURS statement
 - COBOL example [342](#)
- On End of Data tab
 - Java transformation [229](#)
- On Input Row tab
 - example [261](#)
 - Java transformation [228](#)
- On Receiving Transaction tab
 - Java transformation [229](#)
- operators
 - lookup condition [298](#)
- Oracle
 - connect string syntax [414](#)
 - stored procedure notes [444](#)
- ORDER BY
 - lookup query [294](#)
 - override [294](#)
 - overriding [294](#)
- outer join
 - creating [397](#)
 - creating as a join override [397](#)
 - creating as an extract override [398](#)
 - Integration Service supported types [392](#)
 - See also join type[outer join aab] [397](#)
- Output Hierarchy tab
 - Unstructured Data transformation [475](#)
- Output is Deterministic (property)
 - External Procedure transformation [162](#)
 - Java transformation [224](#)
 - Stored Procedure transformation [448](#)
- Output is Ordered (property)
 - Java transformation [224](#)
- Output is Repeatable (property)
 - External Procedure transformation [162](#)
 - Stored Procedure transformation [448](#)
- Output Old Value On Update (property)
 - description [288](#)
- output parameters
 - stored procedures [440](#)
 - unconnected Stored Procedure transformation [450](#)
- output ports
 - default values [38](#)
 - error handling [38](#)
 - Java transformations [223](#)

- output ports (*continued*)
 - overview [30](#)
 - required for Expression transformation [158](#)
 - using as variables [228](#)
- output row
 - setting row type in Java transformation [242](#)
- OutputBuffer port
 - Unstructured Data transformation [472](#)
- OutputFileName port
 - Unstructured Data transformation [472](#)
- OutputType
 - Unstructured Data transformation [471](#)
- overriding
 - default Source Qualifier SQL query [390](#)

P

- parameter access functions
 - 64-bit [189](#)
 - description [189](#)
- parameter binding
 - SQL transformation queries [408](#)
- parser
 - Data Transformation [469](#)
 - Data Transformation output [477](#)
- partial query
 - substituting [410](#)
- partition related functions
 - description [192](#)
- partitioned pipelines
 - joining sorted data [270](#)
- pass-through ports
 - adding to SQL transformation [411](#)
- pass-through ports
 - default values [38](#)
- passive mode
 - SQL transformation [412](#)
- passive transformations
 - configuring SQL transformation [411](#)
 - Expression [157](#)
 - Java [219](#), [220](#)
 - Lookup [280](#)
 - overview [25](#)
 - Sequence Generator [367](#)
 - Stored Procedure [439](#)
- performance
 - Aggregator transformation [55](#)
 - improving filter [196](#)
 - Joiner transformation [278](#)
 - logical database connections [415](#)
 - Lookup transformation [305](#)
 - static database connections [415](#)
 - using variables to improve [35](#)
- persistent lookup cache
 - named and unnamed [311](#)
 - named files [313](#)
 - overview [311](#)
 - recache from database [309](#)
 - sharing [313](#)
- pipeline lookup
 - configuring session properties [293](#)
 - description [280](#)
 - Lookup transformation example [283](#)
 - Lookup transformation properties [283](#)
 - mapping [283](#)
 - mapping example [283](#)
 - non-reusable transformation [305](#)

- pipeline lookup (*continued*)
 - reusable transformation [304](#)
- pipeline Normalizer transformation
 - creating [350](#)
 - description [347](#)
 - Normalizer tab [349](#)
 - Ports tab [348](#)
- pipeline partitioning
 - Custom transformation [64](#)
 - HTTP transformation [200](#)
- pipelines
 - merging with Union transformation [464](#)
- populating ports
 - Unstructured Data transformation [474](#)
- port attributes
 - editing [64](#)
 - overview [64](#)
- port dependencies
 - Custom transformation [63](#)
- port values
 - Java transformations [223](#)
- ports
 - Aggregator transformation [51](#)
 - configure [30](#)
 - configuring [29](#)
 - creating [29](#)
 - Custom transformation [62](#)
 - default values overview [38](#)
 - evaluation order [37](#)
 - group by [53](#)
 - HTTP transformation [201](#)
 - Java transformation [222](#)
 - Lookup transformation [286](#)
 - Rank transformation [357](#)
 - Router transformation [365](#)
 - Sequence Generator transformation [368](#)
 - sorted [55](#), [400](#)
 - sorted ports option [400](#)
 - Source Qualifier [400](#)
 - Union transformation [465](#)
 - Unstructured Data transformation [474](#)
 - variables ports [36](#)
- post-session
 - errors [454](#)
 - stored procedures [453](#)
- pre- and post-session SQL
 - Source Qualifier transformation [401](#)
- Pre-build Lookup Cache
 - lookup property [288](#)
- pre-session
 - errors [454](#)
 - stored procedures [453](#)
- primary keys
 - creating with Sequence Generator transformation [370](#)
- process variables
 - in initialization properties [187](#)
- Programmatic Identifier (property)
 - External Procedure transformation [162](#)
- promoting
 - non-reusable transformations [47](#)
- property access function
 - description [188](#)
- property functions
 - Custom transformation [96](#)
- property IDs
 - Custom transformation [97](#)

Q

- queries
 - Lookup transformation [294](#)
 - overriding lookup [294](#)
 - Source Qualifier transformation [386](#), [390](#)
- query mode
 - rules and guidelines [412](#)
 - SQL transformation [407](#)
- quoted identifiers
 - reserved words [386](#)

R

- random masking
 - masking date values [136](#)
 - masking string values [136](#)
 - numeric values [135](#)
- range
 - masking numeric values [139](#)
- Rank transformation
 - creating [359](#)
 - defining groups for [358](#)
 - options [357](#)
 - overview [356](#)
 - ports [357](#)
 - RANKINDEX port [358](#)
 - using variables [35](#)
- ranking
 - groups of data [358](#)
 - string values [357](#)
- real-time data
 - processing with Joiner transformation [277](#)
 - with Joiner transformation [275](#)
- rebind datatype functions
 - Custom transformation functions [103](#)
- recache from database
 - named cache [311](#)
 - overview [309](#)
 - unnamed cache [311](#)
- registering
 - COM procedures with repositories [168](#)
- reinitializing lookup cache
 - See recache from database [309](#)
- reject file
 - update strategies [481](#)
- relational databases
 - joining [265](#)
- relational hierarchies
 - Unstructured Data transformation [475](#)
- repeatable dependent masking
 - description [135](#)
- repeatable output
 - Data Masking transformation [127](#)
- repositories
 - COM external procedures [168](#)
 - registering COM procedures with [168](#)
- Requires Single Thread (property)
 - Custom transformation [64](#)
- Requires Single Thread per Partition (property)
 - HTTP transformation [200](#)
 - Java transformation [224](#)
- reserved words
 - generating SQL with [386](#)
 - lookup query [295](#)
 - resword.txt [386](#)

- reset
 - Sequence Generator transformation [376](#)
- Reset (property)
 - Sequence Generator transformation [376](#)
- resilience
 - SQL transformation databases [418](#)
- result string replacement characters
 - Data Masking transformation [139](#)
- return multiple rows
 - Lookup transformation [300](#)
- return port
 - Lookup transformation [286](#), [302](#)
- return values
 - from external procedures [181](#)
 - Lookup transformation [302](#)
 - Stored Procedure transformation [440](#)
- reusable transformations
 - adding to mappings [47](#)
 - changing [48](#)
 - creating [46](#)
 - creating a non-reusable instance [47](#)
 - mapping variables [46](#)
 - overview [45](#)
- right outer join
 - creating [396](#)
 - syntax [396](#)
- rollback
 - Java transformation API method [241](#)
- Router transformation
 - connecting in mappings [366](#)
 - creating [366](#)
 - example [363](#)
 - filtering Normalizer data [351](#)
 - group filter condition [363](#)
 - groups [363](#)
 - overview [361](#)
 - ports [365](#)
- routing rows
 - transformation for [361](#)
- row strategy functions
 - array-based [121](#)
 - row-based [114](#)
- Row transformation scope
 - behavior in Joiner transformation [275](#)
- row-based functions
 - data handling [105](#)
 - row strategy [114](#)
- rows
 - deleting [484](#)
 - flagging for update [481](#)
- rules
 - default values [44](#)
- Runtime Location (property)
 - External Procedure transformation [162](#)

S

- script mode
 - rules and guidelines [407](#)
 - SQL transformation [406](#)
- ScriptError port
 - description [406](#)
- ScriptName port
 - SQL transformation [406](#)
- ScriptResults port
 - SQL transformation [406](#)

- scripts locale option
 - SQL transformation [425](#)
- seed value
 - Data Masking transformation [127](#)
- select distinct
 - overriding in sessions [401](#)
 - Source Qualifier option [401](#)
- Sequence Generator transformation
 - advanced properties [376](#)
 - Blaze engine [377](#)
 - creating [376](#)
 - creating composite key [370](#)
 - Current Value [374](#)
 - CURRVAL port [370](#)
 - cycle [373](#)
 - Cycle [373](#)
 - Increment By property [373](#)
 - NEXTVAL port [368](#)
 - Non-native environment [377](#)
 - non-reusable [375](#)
 - number of cached values [374](#)
 - overview [367](#)
 - ports [368](#)
 - properties [371](#), [376](#)
 - range of values [373](#)
 - reset [376](#)
 - reusable [375](#)
 - Spark engine [377](#)
 - start value [373](#)
 - using IIF function to replace missing keys [370](#)
- sequence ID
 - Lookup transformation [322](#)
- sequential caches
 - See caches [309](#)
- serializer
 - Data Transformation [469](#)
- session logs
 - Java transformations [241](#)
- sessions
 - \$\$\$SessStartTime [385](#)
 - configuring to handle stored procedure errors [454](#)
 - External Procedure transformation [169](#)
 - incremental aggregation [49](#)
 - overriding select distinct [401](#)
 - pre- and post-stored procedures, running [453](#)
 - setting update strategy [483](#)
 - Stored Procedure transformation [441](#)
- set data code page function
 - Custom transformation function [113](#)
- setNull method
 - Java transformations [242](#)
- setOutRowType
 - Java transformation API method [242](#)
- shared storage table
 - Data Masking transformation [149](#)
- sharing
 - named lookup caches [315](#)
 - unnamed lookup caches [313](#)
- simple interface
 - example [249](#)
 - Java expressions [248](#)
 - Java transformation API methods [248](#)
- SIN numbers
 - masking Social Insurance numbers [147](#)
 - repeatable data masking [148](#)
- Social Security numbers
 - area code masking [144](#)
 - repeatable data masking [145](#)
- sort order
 - Aggregator transformation [56](#)
 - configuring for Joiner transformation [271](#)
 - Source Qualifier transformation [400](#)
- sort origin
 - configuring the join condition to use [270](#)
 - definition [270](#)
- sorted data
 - joining from partitioned pipelines [270](#)
 - using in Joiner transformation [270](#)
- sorted flat files
 - using in Joiner transformation [271](#)
- sorted input
 - flat file lookups [282](#)
- Sorted Input (property)
 - Aggregator transformation [55](#)
 - Joiner transformation [266](#)
- sorted ports
 - Aggregator transformation [55](#)
 - caching requirements [51](#)
 - pre-sorting data [56](#)
 - reasons not to use [55](#)
 - sort order [400](#)
 - Source Qualifier [400](#)
- sorted relational data
 - using in Joiner transformation [271](#)
- Sorter transformation
 - configuring [379](#)
 - configuring Sorter Cache Size [380](#)
 - creating [381](#)
 - overview [378](#)
 - properties [379](#)
 - using with Joiner transformation [271](#)
 - work directory [380](#)
- \$\$Source
 - Stored Procedure transformations [448](#)
 - Lookup transformations [288](#)
- Source Analyzer
 - creating key relationships [389](#)
- source filters
 - adding to Source Qualifier [399](#)
- Source Qualifier transformation
 - \$\$\$SessStartTime [385](#)
 - as a lookup source [283](#)
 - configuring [402](#)
 - creating key relationships [389](#)
 - custom joins [389](#)
 - datatypes [384](#)
 - default join [388](#)
 - default query [386](#)
 - entering source filter [399](#)
 - entering user-defined join [391](#)
 - joining source data [388](#)
 - joins [389](#)
 - mapping parameters and variables [385](#)
 - Number of Sorted Ports option [400](#)
 - outer join support [392](#)
 - overriding default query [387](#), [390](#)
 - overview [383](#)
 - pre- and post-session SQL [401](#)
 - properties [402](#)
 - Select Distinct option [401](#)
 - sort order with Aggregator [56](#)
 - SQL override [390](#)
 - target load order [384](#)
 - troubleshooting [403](#)
 - viewing default query [387](#)
 - XML Source Qualifier [486](#)

- source string characters
 - Data Masking transformation [138](#)
- sources
 - joining [265](#)
 - joining data from the same source [273](#)
 - joining multiple [265](#)
 - merging [464](#)
- special format masking
 - email addresses [146](#)
 - IP addresses [148](#)
 - phone numbers [145](#)
 - repeatable SIN numbers [148](#)
 - Social Insurance numbers [147](#)
 - Social Security numbers [144](#)
 - URLs [148](#)
- splitting XML
 - Unstructured Data transformation [477](#)
- SQL
 - adding custom query [390](#)
 - overriding default query [387](#), [390](#)
 - viewing default query [387](#)
- SQL override
 - default query [387](#)
- SQL Ports tab
 - SQL transformation [425](#)
- SQL query
 - adding custom query [390](#)
 - dynamic connection example [434](#)
 - dynamic update example [429](#)
 - overriding default query [387](#), [390](#)
 - viewing default query [387](#)
- SQL settings tab
 - SQL transformation [425](#)
- SQL statements
 - supported by SQL transformation [426](#)
- SQL transformation
 - advanced options [414](#)
 - configuring connections [413](#)
 - database resiliency [417](#)
 - database resiliency [418](#)
 - description [405](#)
 - dynamic connection example [434](#)
 - dynamic query example [429](#)
 - dynamic SQL queries [409](#)
 - exactly-once message delivery [417](#)
 - HA recovery guidelines [417](#)
 - native datatype column [408](#)
 - NumRowsAffected [420](#)
 - pass-through ports [411](#)
 - passing full connection information [413](#)
 - passive mode [411](#), [412](#)
 - PM_REC_STATE table
 - SQL transformation recovery [417](#)
 - properties [423](#)
 - query mode [407](#)
 - script mode [406](#)
 - ScriptError port [406](#)
 - ScriptName port [406](#)
 - ScriptResults port [406](#)
 - SELECT queries [408](#)
 - setting SQL attributes [425](#)
 - setting Verbose Data [423](#)
 - SQL ports description [425](#)
 - static query ports [408](#)
 - static SQL queries [408](#)
 - supported SQL statements [426](#)
 - transaction control [416](#)
 - using string substitution [409](#)

- start digit
 - Social Insurance numbers [148](#)
- start value
 - Sequence Generator transformation [373](#)
- Start Value (property)
 - Sequence Generator transformation [371](#)
- static code
 - Java transformations [227](#)
- static database connection
 - description [413](#)
 - performance considerations [415](#)
- static lookup cache
 - overview [312](#)
- static SQL queries
 - configuring ports [408](#)
 - SQL transformation [408](#)
- static variables
 - Java transformations [227](#)
- status codes
 - Stored Procedure transformation [441](#)
- status tracing level
 - Unstructured Data transformation [472](#)
- storage commit interval
 - Data Masking transformation [149](#)
- storage encryption key
 - Data Masking transformation [149](#)
- storage table
 - expression masking [141](#)
 - substitution data masking [131](#)
- Stored Procedure transformation
 - Call Text (property) [448](#)
 - configuring [443](#)
 - configuring connected stored procedure [449](#)
 - configuring unconnected stored procedure [450](#)
 - connected [441](#)
 - Connection Information (property) [448](#)
 - creating by importing [445](#)
 - creating manually [447](#), [448](#)
 - Execution Order (property) [448](#)
 - expression rules [456](#)
 - importing stored procedure [446](#)
 - input data [440](#)
 - input/output parameters [440](#)
 - modifying [449](#)
 - output data [440](#)
 - Output is Deterministic (property) [448](#)
 - Output is Repeatable (property) [448](#)
 - overview [439](#)
 - performance tips [457](#)
 - pre- and post-session [453](#)
 - properties [448](#)
 - return values [440](#)
 - running pre- or post-session [453](#)
 - session runtime, specifying [442](#)
 - setting options [448](#)
 - specifying when run [442](#)
 - status codes [441](#)
 - Stored Procedure Type (property) [448](#)
 - subsecond precision for datetime ports [448](#)
 - Tracing Level (property) [448](#)
 - troubleshooting [457](#)
 - unconnected [441](#), [450](#)
- Stored Procedure Type (property)
 - Stored Procedure transformation [448](#)
- stored procedures
 - changing parameters [449](#)
 - creating sessions for pre or post-session run [453](#)
 - database-specific syntax notes [444](#)

- stored procedures (*continued*)
 - definition [439](#)
 - error handling [454](#)
 - IBM DB2 example [445](#)
 - importing [446](#)
 - Informix example [444](#)
 - load types [453](#)
 - Microsoft example [445](#)
 - Oracle example [444](#)
 - order of processing, specifying [442](#)
 - post-session errors [454](#)
 - pre-session errors [454](#)
 - session errors [455](#)
 - setting type of [448](#)
 - Sybase example [445](#)
 - Teradata example [445](#)
 - writing [443](#)
 - writing to variables [37](#)
- storeMetadata method
 - Java transformations [243](#)
- Streamer Chunk Size
 - Unstructured Data transformation [471](#)
- streamer component
 - Data Transformation [469](#)
- string substitution
 - SQL transformation queries [409](#)
- string values
 - custom data masking [136](#)
 - key data masking [128](#)
- strings
 - ranking [357](#)
- subsecond precision
 - Lookup transformation [288](#)
 - Stored Procedure transformation [448](#)
- subseconds
 - processing in Java transformation [232](#)
- substitution masking
 - configuring relational dictionaries [133](#)
 - data masking rules and guidelines [133](#)
 - description [130](#)
 - masking properties [131](#)
- surnames.dic
 - masking data [151](#)
- Sybase ASE
 - connect string syntax [414](#)
 - ORDER BY limitation [294](#)
 - stored procedure notes [445](#)
- syntax
 - common database restrictions [398](#)
 - creating left outer joins [394](#)
 - creating normal joins [393](#)
 - creating right outer joins [396](#)

T

- tables
 - creating key relationships [389](#)
- \$Target
 - Stored Procedure transformations [448](#)
 - Lookup transformations [288](#)
- target load order
 - Source Qualifier [384](#)
- target tables
 - deleting rows [484](#)
 - inserts [484](#)
 - setting update strategy for [484](#)

- targets
 - updating [480](#)
- TC_COMMIT_AFTER constant
 - description [459](#)
- TC_COMMIT_BEFORE constant
 - description [459](#)
- TC_CONTINUE_TRANSACTION constant
 - description [459](#)
- TC_ROLLBACK_AFTER constant
 - description [459](#)
- TC_ROLLBACK_BEFORE constant
 - description [459](#)
- Teradata
 - connect string syntax [414](#)
- Terse tracing levels
 - defined [44](#)
- thread-specific operations
 - Custom transformations [64](#)
 - HTTP transformations [200](#)
 - writing [66](#)
- threads
 - Custom transformation [66](#)
- TINFParm parameter type
 - definition [184](#)
- tracing level function
 - description [192](#)
- tracing levels
 - External Procedure transformation property [162](#)
 - Java transformation property [224](#)
 - Joiner transformation property [266](#)
 - Normal [44](#)
 - overriding [44](#)
 - overview [44](#)
 - Sequence Generator transformation property [376](#)
 - session properties [50](#)
 - Sorter transformation property [381](#)
 - Stored Procedure transformation property [448](#)
 - Terse [44](#)
 - Verbose Data [44](#)
 - Verbose Initialization [44](#)
- tracing messages
 - for external procedures [182](#)
- transaction
 - definition [459](#)
 - generating [67](#), [226](#), [236](#)
 - working with in Joiner transformation [275](#)
- transaction boundary
 - Custom transformation [68](#)
 - dropping in Joiner transformation [277](#)
 - preserving in Joiner transformation [276](#)
- transaction control
 - Custom transformation [67](#)
 - example [460](#)
 - expression [459](#)
 - Java transformation [225](#)
 - overview [458](#)
 - SQL transformation [416](#)
 - transformation [459](#)
- Transaction Control transformation
 - creating [463](#)
 - effective [461](#)
 - in mappings [461](#)
 - ineffective [461](#)
 - mapping validation [462](#)
 - overview [459](#)
 - properties [459](#)
- Transaction transformation scope
 - behavior in Joiner transformation [275](#)

- Transformation Developer
 - reusable transformations [45](#)
- Transformation Exchange (TX)
 - definition [160](#)
- transformation language
 - aggregate functions [52](#)
 - using with Java expressions [246](#)
- transformation scope
 - All Input transformation scope with Joiner transformation [275](#)
 - Custom transformation [67](#)
 - defining for Joiner transformation [275](#)
 - Java transformation [225](#)
 - Joiner transformation property [266](#)
 - Row transformation scope with Joiner transformation [275](#)
 - Sorter transformation [381](#)
 - Transaction transformation scope with Joiner transformation [275](#)
- Transformation Scope (property)
 - Java transformation [224](#)
- transformations
 - active and passive [24](#)
 - adding to mappings [28](#)
 - Aggregator [49](#)
 - connected [25](#)
 - creating [28](#)
 - Custom [59](#)
 - definition [24](#)
 - descriptions [26](#)
 - Expression [157](#)
 - Filter [194](#)
 - handling errors [42](#)
 - Java [219](#)
 - Joiner [265](#)
 - Lookup [280](#)
 - making reusable [47](#)
 - multi-group [30](#)
 - native and non-native [25](#)
 - Normalizer [338](#)
 - overview [24](#)
 - promoting to reusable [47](#)
 - Rank [356](#)
 - reusable transformations [45](#)
 - Router [361](#)
 - Sequence Generator [367](#)
 - Source Qualifier [383](#)
 - SQL [405](#)
 - Stored Procedure [439](#)
 - tracing levels [44](#)
 - types [24](#)
 - types that allow for expressions [31](#)
 - unconnected [25](#)
 - Union [464](#)
 - Update Strategy [480](#)
 - XML Generator [487](#)
 - XML Parser [486](#)
 - XML Source Qualifier [486](#)
- transformer component
 - Data Transformation [469](#)
- Treat Source Rows As
 - update strategy [483](#)
- troubleshooting
 - Aggregator transformation [58](#)
 - Java transformation [233](#)
 - Normalizer transformation [354](#)
 - Source Qualifier transformation [403](#)
 - Stored Procedure transformation [457](#)
- TX-prefixed files
 - external procedures [174](#)

U

- UDT settings
 - Unstructured Data transformation [471](#)
- unconnected Lookup transformation
 - input ports [301](#)
 - return port [302](#)
- unconnected lookups
 - adding lookup conditions [301](#)
 - calling through expressions [302](#)
 - description [284](#)
 - designating return values [302](#)
 - overview [285, 301](#)
- unconnected transformations
 - External Procedure transformation [184](#)
 - Lookup [280](#)
 - Lookup transformation [285, 301](#)
 - Stored Procedure transformation [439](#)
- Unicode mode
 - configuring sort order for Joiner transformation [270](#)
 - Custom transformation [60](#)
 - External Procedure Transformation [161](#)
- Union transformation
 - components [465](#)
 - creating [465](#)
 - groups [465](#)
 - guidelines [464](#)
 - overview [464](#)
 - ports [465](#)
- unique output
 - Data Masking transformation [132](#)
- unnamed cache
 - persistent [311](#)
 - recache from database [311](#)
 - sharing [313](#)
- unsorted Joiner transformation
 - processing detail rows [275](#)
 - processing master rows [275](#)
- Unstructured Data transformation
 - components [469](#)
 - configuring [478](#)
 - exporting to XML schema [475](#)
 - file output type example [477](#)
 - flushing input data [475](#)
 - InputBuffer port [472](#)
 - OutputBuffer port [472](#)
 - OutputFileName port [472](#)
 - overview [467](#)
 - populating ports from Data Transformation [474](#)
 - ports [474](#)
 - setting status tracing level [472](#)
 - splitting XML output [477](#)
 - UDT Settings tab [471](#)
 - writing to an XML file [477](#)
 - writing to relational targets [475, 476](#)
- Update as Insert (property)
 - description [484](#)
- Update as Update (property)
 - description [484](#)
- Update else Insert (property)
 - description [484](#)
- Update Else Insert (property)
 - description [329](#)
- update strategy
 - row strategy functions (row-based) [114](#)
 - setting with a Custom transformation [66](#)
 - setting with a Java transformation [226](#)

- Update Strategy transformation
 - Aggregator combination [482](#)
 - checklist [484](#)
 - creating [481](#)
 - entering expressions [481](#)
 - forwarding rejected rows [481](#)
 - Lookup combination [482](#)
 - overview [480](#)
 - setting options for sessions [483](#), [484](#)
 - steps to configure [480](#)
- Update Strategy Transformation (property)
 - Java transformation [224](#)
- URL
 - adding through business documentation links [33](#)
- Use Connection Pooling (property)
 - SQL transformation [425](#)
- user code errors
 - Java transformations [234](#)
- user-defined functions
 - using with Java expressions [246](#)
- user-defined group
 - Router transformation [363](#)
- user-defined joins
 - entering [391](#)
- user-defined methods
 - Java transformation [228](#), [229](#)
 - Java transformations [227](#)

V

- Validate button
 - transformations [44](#)
- validating
 - default values [44](#)
 - expressions [33](#)
- values
 - calculating with Expression transformation [158](#)
- variable ports
 - overview [36](#)
- variables
 - initializations [38](#)
 - Java transformation [228](#), [229](#)
 - Java transformations [227](#)
 - overview [35](#), [36](#)
 - port evaluation order [37](#)
 - stored procedure results, capturing [37](#)
- Verbose Data tracing level
 - overview [44](#)
 - SQL transformation [423](#)
- Verbose Initialization tracing level
 - overview [44](#)

- Vertica
 - connect string syntax [414](#)
- Visual Basic
 - adding functions to Integration Service [182](#)
 - Application Setup Wizard [179](#)
 - code for external procedures [161](#)
 - COM datatypes [180](#)
 - developing COM external procedures [170](#)
 - distributing procedures manually [180](#)
 - wrapper classes for [182](#)
- Visual C++
 - adding libraries to Integration Service [182](#)
 - COM datatypes [180](#)
 - developing COM external procedures [165](#)
 - distributing procedures manually [180](#)
 - wrapper classes for [182](#)
- VSAM Normalizer transformation
 - creating [346](#)
 - description [342](#)
 - Normalizer tab [345](#)
 - Ports tab [344](#)

W

- web links
 - adding to expressions [33](#)
- Windows systems
 - compiling DLLs on [177](#)
- wizards
 - ATL COM AppWizard [165](#)
 - MFC AppWizard [177](#)
 - Visual Basic Application Setup Wizard [179](#)
- work directory
 - Sorter transformation, specifying [380](#)
- wrapper classes
 - for pre-existing libraries or functions [182](#)

X

- XML
 - splitting large output [477](#)
- XML Generator transformation
 - overview [487](#)
- XML Parser transformation
 - enabling split input [477](#)
 - overview [486](#)
- XML transformations
 - Source Qualifier [486](#)
 - XML Generator [487](#)
 - XML Parser [486](#)